

DIRECT GLAZE ROUND TOP – Double Hung

RT6 EYEBROW ABOVE SPRINGLINE STANDARD SIZES - DIRECT GLAZE

RO (mm)	2-2 3/8 (670)	2-6 3/8 (772)	2-8 3/8 (822)	2-10 3/8 (873)	3-0 3/8 (924)	3-2 3/8 (975)	3-6 3/8 (1076)
RO Rad. (mm)	2-0 1/2 (622)	2-0 1/2 (622)	2-6 1/2 (775)	2-6 1/2 (775)	2-6 1/2 (775)	3-4 1/2 (1029)	3-4 1/2 (1029)
RO (mm)	1-0 1/2 (318)	0-7 7/32 (183)	0-7 7/8 (200)	0-7 3/16 (183)	0-6 1/2 (165)	0-7 11/16 (195)	0-6 1/2 (165)
RO Sph. (mm)	0-8 5/8 (219)						
	UDGRT 2511	UDGRT2911	UDGRT3111	UDGRT3311	UDGRT3511	UDGRT3711	UDGRT4111
	1-6 1/2 (470)	1-1 7/32 (336)	1-1 7/8 (352)	1-1 3/16 (335)	1-0 1/2 (318)	1-1 1/16 (348)	1-0 1/2 (318)
	UDGRT2519	UDGRT 2919	UDGRT3119	UDGRT3319	UDGRT3519	UDGRT3719	UDGRT4119
	2-0 1/2 (622)	1-7 7/32 (488)	1-7 7/8 (505)	1-7 3/16 (487)	1-6 1/2 (470)	1-7 1/16 (500)	1-6 1/2 (470)
	UDGRT 2523	UDGRT2923	UDGRT3123	UDGRT3323	UDGRT3523	UDGRT3723	UDGRT4123
	3-0 1/2 (827)	2-7 7/32 (793)	2-7 7/8 (810)	2-7 3/16 (792)	2-6 1/2 (775)	2-7 11/16 (805)	2-6 1/2 (775)
	UDGRT 2535	UDGRT2935	UDGRT3135	UDGRT3335	UDGRT3535	UDGRT 3735	UDGRT4135
	4-0 1/2 (1032)	3-7 7/32 (1098)	3-7 7/8 (1114)	3-7 3/16 (1097)	3-6 1/2 (1080)	3-7 11/16 (1110)	3-6 1/2 (1080)
	UDGRT2547	UDGRT2947	UDGRT3147	UDGRT3347	UDGRT 3547	UDGRT3747	UDGRT4147
	5-0 1/2 (1537)	4-7 7/32 (1403)	4-7 7/8 (1419)	4-7 3/16 (1402)	4-6 1/2 (1384)	4-7 11/16 (1414)	4-6 1/2 (1384)
	UDGRT2559	UDGRT2959	UDGRT 3159	UDGRT 3359	UDGRT3559	UDGRT3759	UDGRT4159
	6-0 1/2 (1842)	5-7 7/32 (1707)	5-7 7/8 (1724)	5-7 3/16 (1707)	5-6 1/2 (1689)	5-7 11/16 (1719)	5-6 1/2 (1689)
	UDGRT 2571	UDGRT2971	UDGRT3171	UDGRT3371	UDGRT3571	UDGRT3771	UDGRT4171
RO (mm)	5-8 5/8 (1438)						
RO Sph. (mm)							

Details and Elevations not to scale.

E These windows meet national Egress codes for fire evacuation. Local codes may differ.































Please consult your local Marvin representative for masonry openings that include casings and subsills.

For further details and drawings visit the 'Tools and Documents' section at Marvin.com.

Ultimate Direct Glaze Round Top: UDGRT

DIRECT GLAZE ROUND TOP – Double Hung

RT6 EYEBROW ABOVE SPRINGLINE STANDARD SIZES - DIRECT GLAZE

RO (mm)	3-10 3/8 (1178)	4-3 3/4 (1314)	4-11 3/4 (1518)	5-7 3/4 (1721)	6-3 3/4 (1924)
RO Rad. (mm)	3-4 1/2 (1029)	3-4 1/2 (1029)	4-6 1/2 (1384)	6-0 1/2 (1842)	6-0 1/2 (1842)
RO (mm)	1-6 1/2 (470)	0-9 5/32 (233)	0-9 9/16 (243)	0-10 1/8 (257)	0-7 13/16 (198)
RO Spln. (mm)	0-11 7/32 (285)	1-3 5/32 (385)	1-3 9/16 (395)	1-4 1/8 (410)	1-1 13/16 (351)
					
	UDGRT4519	UDGRT5119	UDGRT5919	UDGRT6719	UDGRT7519
					
	UDGRT4523	UDGRT5123	UDGRT5923	UDGRT6723	UDGRT7523
					
	UDGRT4535	UDGRT5135	UDGRT5935	UDGRT6735	UDGRT7535
					
	UDGRT4547	UDGRT5147	UDGRT5947	UDGRT6747	UDGRT7547
					
	UDGRT4559	UDGRT5159	UDGRT5959	UDGRT6759	UDGRT7559
					
	UDGRT4571	UDGRT5171	UDGRT5971	UDGRT6771	UDGRT7571
RO (mm)	5-0 1/2 (1537)	4-3 5/32 (985)	3-3 9/16 (1005)	3-4 1/8 (1019)	3-1 13/16 (860)
RO Spln. (mm)	4-5 7/32 (1352)	3-3 5/32 (985)	3-3 9/16 (1005)	3-4 1/8 (1019)	3-1 13/16 (860)
RO (mm)	6-0 1/2 (1842)	4-3 5/32 (1299)	4-3 9/16 (1310)	4-4 1/8 (1324)	4-1 13/16 (1265)
RO Spln. (mm)	5-5 7/32 (1657)	4-3 5/32 (1299)	4-3 9/16 (1310)	4-4 1/8 (1324)	4-1 13/16 (1265)
RO (mm)	5-0 1/2 (1537)	4-3 5/32 (1299)	4-3 9/16 (1310)	4-4 1/8 (1324)	4-1 13/16 (1265)
RO Spln. (mm)	4-5 7/32 (1352)	4-3 5/32 (1299)	4-3 9/16 (1310)	4-4 1/8 (1324)	4-1 13/16 (1265)
RO (mm)	6-0 1/2 (1842)	5-3 5/32 (1604)	5-3 9/16 (1614)	5-4 1/8 (1629)	5-1 13/16 (1570)
RO Spln. (mm)	5-5 7/32 (1657)	5-3 5/32 (1604)	5-3 9/16 (1614)	5-4 1/8 (1629)	5-1 13/16 (1570)
RO (mm)	6-0 1/2 (1842)	5-3 5/32 (1604)	5-3 9/16 (1614)	5-4 1/8 (1629)	5-1 13/16 (1570)
RO Spln. (mm)	5-5 7/32 (1657)	5-3 5/32 (1604)	5-3 9/16 (1614)	5-4 1/8 (1629)	5-1 13/16 (1570)

DIRECT GLAZE ROUND TOP – Double Hung

RT1 TRUE HALF CIRCLE STANDARD SIZES - DIRECT GLAZE

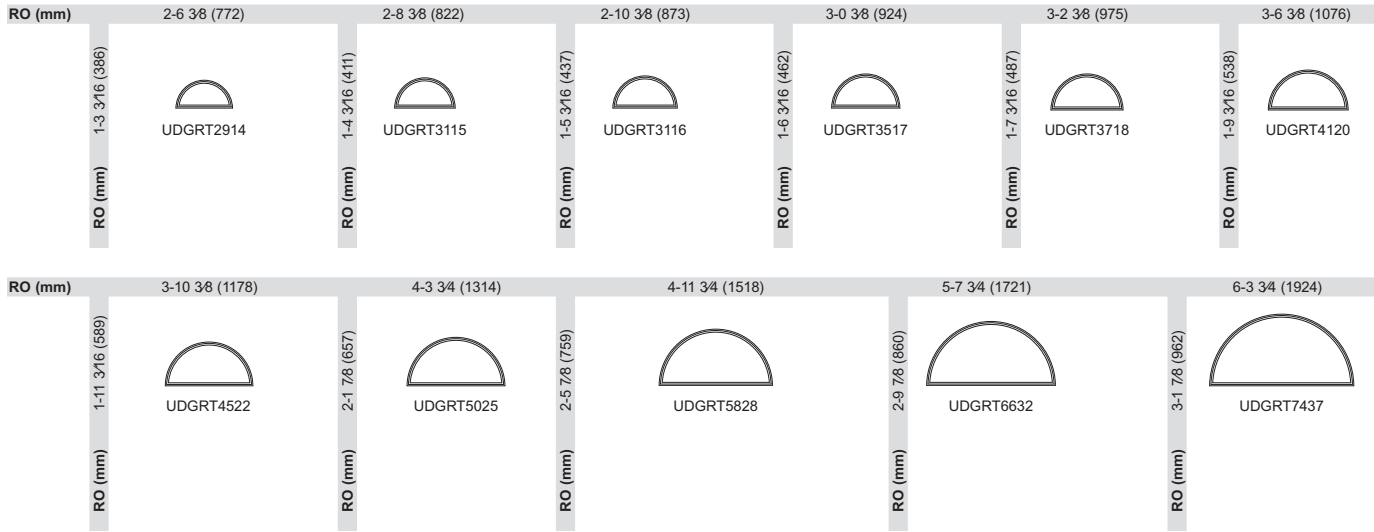

RT29 ELLIPTICAL STANDARD SIZES - DIRECT GLAZE

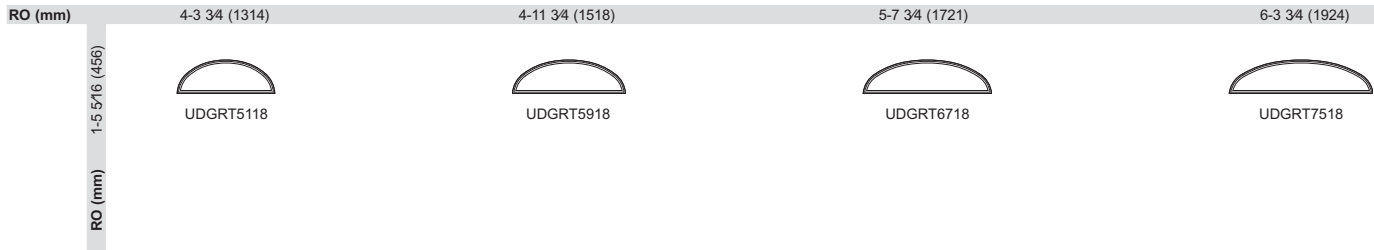

Details and Elevations not to scale.



E These windows meet national Egress codes for fire evacuation. Local codes may differ.

Please consult your local Marvin representative for masonry openings that include casings.



For further details and drawings visit the 'Tools and Documents' section at Marvin.com.

DIRECT GLAZE ROUND TOP – Double Hung

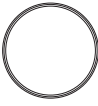
RT27 FULL CIRCLE STANDARD SIZES - DIRECT GLAZE

RO (mm)	2-1 1/2 (648)	3-1 1/2 (953)	4-1 1/2 (1257)
RO (mm)	2-1 1/2 (648)	3-1 1/2 (953)	4-1 1/2 (1257)
	 <p>UDGTR 2750</p>	 <p>UDGRT 3950</p>	 <p>UDGRT 5150</p>

RT28 FULL ELLIPSE STANDARD SIZES - DIRECT GLAZE

RO (mm)	2-1 (635)	2-9 (838)	3-5 (1041)
RO (mm)	3-1 (940)	4-1 (1245)	5-1 (1549)
	 <p>UDGRT 2436</p>	 <p>UDGRT 3248</p>	 <p>UDGRT 4060</p>

CONSTRUCTION DETAILS

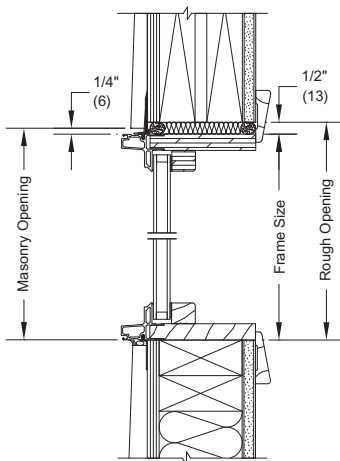

HEAD JAMB AND SILL - DIRECT GLAZE

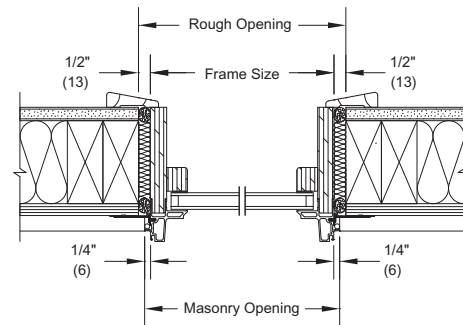

JAMB - DIRECT GLAZE