

When ordering replacement Sliding Patio Door parts specify part number, description, color (if applicable), and handing (if applicable).

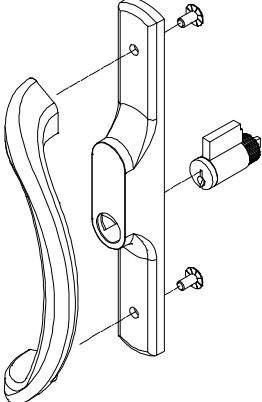
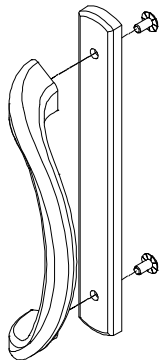
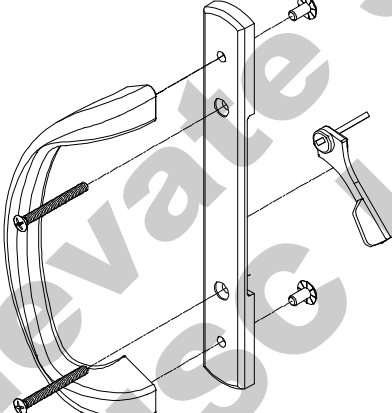
ILLUSTRATION NOT TO SCALE	DESCRIPTION	OPER./COLOR	PART NO.
	<p>Cambridge Handle Set, Exterior Keyed</p> <p><i>Includes:</i></p> <ul style="list-style-type: none"> 1 - Exterior Handle 1 - Keyed Cylinder 2 - Handle Screws 1 - Exterior Escutcheon 	<ul style="list-style-type: none"> Almond Frost White Brass PVD Satin Nickel PVD Oil Rubbed Bronze PVD 	<ul style="list-style-type: none"> 11869066 11869067 11869068 11869069 11869070
	<p>Cambridge Handle Set, Exterior Non-Keyed</p> <p><i>Includes:</i></p> <ul style="list-style-type: none"> 1 - Exterior Handle 2 - Handle Screws 1 - Exterior Escutcheon - Non-keyed 	<ul style="list-style-type: none"> Almond Frost White Brass PVD Satin Nickel PVD Oil Rubbed Bronze PVD 	<ul style="list-style-type: none"> 11869072 11869071 11869073 11869074 11869075
	<p>Cambridge Handle Set, Interior</p> <p><i>Includes:</i></p> <ul style="list-style-type: none"> 1 - Interior Handle 1 - Interior Escutcheon 1 - Thumb Turn 1 - Keeper 2 - #8 x 2 1/2" Installation screws 2 - #8-32 Machine screws 2 - Handle Screws 1 - Instruction 	<ul style="list-style-type: none"> Almond Frost White Brass PVD Satin Nickel PVD Oil Rubbed Bronze PVD 	<ul style="list-style-type: none"> 11869061 11869062 11869063 11869064 11869065

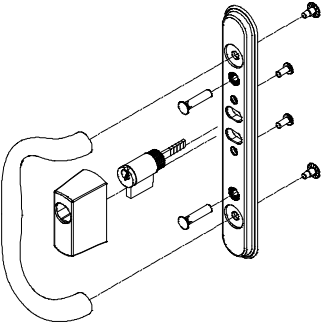
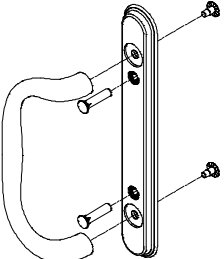
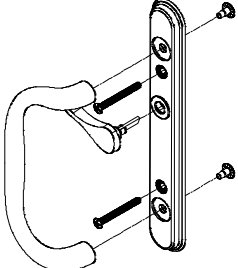


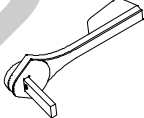
ILLUSTRATION NOT TO SCALE	DESCRIPTION	OPER./COLOR	PART NO.
	<p>Northfield Handle Set, Exterior Keyed Includes: 1 - Exterior Handle 1 - Keyed Cylinder 2 - Handle Screws 1 - Exterior Escutcheon</p>	<p>Almond Frost White Brass PVD Satin Nickel PVD Oil Rubbed Bronze PVD</p>	<p>11869090 11869091 11869092 11869093 11869094</p>
	<p>Northfield Handle Set, Exterior Non-Keyed Includes: 1 - Exterior Handle 2 - Handle Screws 2 - Post Nuts 1 - Exterior Escutcheon - Non-keyed</p>	<p>Almond Frost White Brass PVD Satin Nickel PVD Oil Rubbed Bronze PVD</p>	<p>11869096 11869095 11869097 11869098 11869099</p>
	<p>Northfield Handle Set, Interior Includes: 1 - Interior Handle 1 - Interior Escutcheon 1 - Thumb Turn 1 - Keeper 2 - #8 x 2 1/2" Installation screws 2 - #8-32 Machine screws 2 - Handle Screws 1 - Instruction</p>	<p>Almond Frost White Brass PVD Satin Nickel PVD Oil Rubbed Bronze PVD</p>	<p>11869085 11869086 11869087 11869088 11869089</p>
	<p>Cambridge Keyed Cylinder Includes: 1 - Lock cylinder 2 - Keys NOTE: For keyed alike cylinders, please contact your Marvin representative. Please supply the original order number if possible.</p>		<p>11860975</p>
	<p>Northfield Keyed Cylinder Includes: 1 - Lock cylinder 2 - Keys NOTE: For keyed alike cylinders, please contact your Marvin representative. Please supply the original order number if possible.</p>		<p>11860973</p>
	<p>Cambridge Lock Lever</p>	<p>Almond Frost White Brass PVD Satin Nickel PVD Oil Rubbed Bronze PVD</p>	<p>11897066 11897067 11897068 11897069 11897070</p>





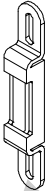
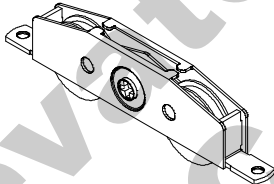
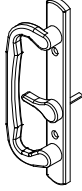

ILLUSTRATION NOT TO SCALE	DESCRIPTION	OPER./COLOR	PART NO.
	Cambridge Machine Screw, #8 x 2"	White Almond Frost Brass Satin Nickel Oil Rubbed Bronze	11897061 11897062 11897063 11897064 11897065
	Northfield Machine Screw, #10 x 1 11/16"	White Almond Frost Brass Satin Nickel Oil Rubbed Bronze	11895060 11895061 11895062 11895064 11895065
	Cambridge Handle Screw, #10-24 x 3/8" Machine Screw		11895050
	Northfield Handle Screw, #10-24 x 3/8" Machine Screw		11895051
	Northfield Escutcheon Post Nut	White Almond Frost Brass Satin Nickel Oil Rubbed Bronze	11884040 11884041 11884042 11884043 11884044
	Mortise Lock Available replacement screws: 2 - #8 x 1" Phillips self tapping flathead screws 11800810		02100960
	Keeper Available replacement screws: OX/XO, OOX/XOO: 2 - #8 x 3" Phillips self tapping pan head screws 11800829 OXO: 2 - #10 x 1" Phillips self tapping pan head screws 11801013		02100962
	Adjustable Panel Roller Available replacement screws: 2 - #8 x 1" Phillips self tapping flathead screws 11800810		10820000

ILLUSTRATION NOT TO SCALE	DESCRIPTION	COLOR	PART NO.
	<p>Interior Handle w/ Turn Lever Usage: 3/2004–7/2009 Used for product 4/2001 to present.</p> <p><i>Includes:</i> 1 – Interior handle 1 – Turn lever 2 – #10 x 3/4 " oval head screws 2 – #10 x 2 " Phillips pan head screws</p>	<p>Brass White Almond Frost</p>	<p>10150050 10150051 10150052</p>
	<p>Exterior Pull Handle* Usage: 4/2001–7/2009</p> <p><i>Includes:</i> 1 – Exterior pull handle 2 – #10 x 2 " Phillips pan head screws (from interior handle)</p>	<p>Stone White Pebble Bronze Evergreen Cashmere *Arctic White</p>	<p>10150060 10150021 10150023 10150029 10150033 10150020</p>

* Arctic White was the standard 1/1997–2/2002.

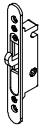
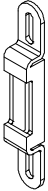
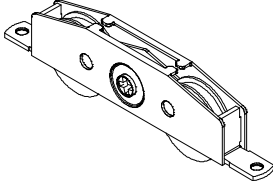
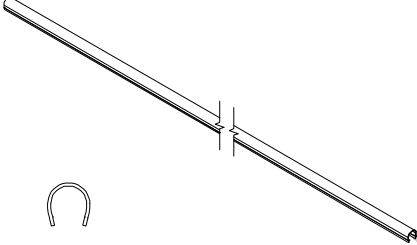
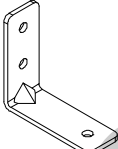
ILLUSTRATION NOT TO SCALE	DESCRIPTION	LENGTH/COLOR	PART NO.
	<p>Mortise Lock Available replacement screws: 2 - #8 x 1" Phillips self tapping flathead screws 11800810</p>		02100960
	<p>Keeper Available replacement screws: OX/XO, OOX/XOO: 2 - #8 x 3" Phillips self tapping pan head screws 11800829 OXO: 2 - #10 x 1" Phillips self tapping pan head screws 11801013</p>		02100962
	<p>Adjustable Panel Roller Available replacement screws: 2 - #8 x 1" Phillips self tapping flathead screws 11800810</p>		10820000
	<p>Stainless Steel Sill Cap</p>	<p>CN 5-0/7-6 OXO width 58" (1473) CN 7-6 OOX, XOO width 87 1/2" (2223) CN 6-0/9-0 OXO width 70" (1778) CN 9-0 OOX, XOO width 105 1/2" (2680)</p>	<p>10500150 10501153 10500155 10500192</p>
	<p>Stationary Panel Bracket Available replacement screws: 3 - #8 x 1" Phillips self tapping pan head Beige screw (11800819)</p>	Beige	10500131

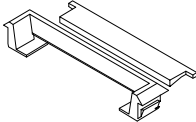
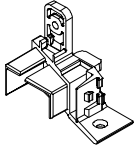


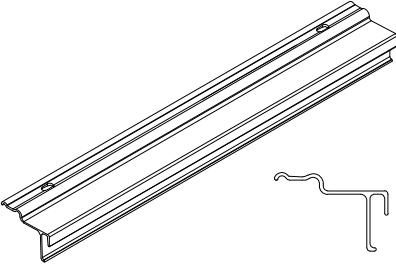
ILLUSTRATION NOT TO SCALE	DESCRIPTION	LENGTH/ COLOR	PART NO.
	Sill Weep Cover and Flap Nylon	Beige	15633099
 NOTE: XO part shown	Sill Leveling Block End Cap Available replacement screws: 1 - #8 x 1/2 " Phillips stainless steel screw (11800516) 1 - #8 x 1 1/2 " Phillips pan head screw (sill) (11865161)	XO OX	10500144 10500145
	Roller Adjustment Hole Cap NOTE: For OOX, XOO configurations, 2 required	Beige	11170001
	Door Stop, NOTE: For OOX, XOO configurations		11872001

ILLUSTRATION NOT TO SCALE	DESCRIPTION	LENGTH/COLOR	PART NO.	
	Aluminum Panel Guide Fastener A1223			
	<i>Available replacement screws: 7-#8x5/8" Trusshead Phillips screws 11800862</i>			
		CN 5-0	56 1/4" (1429)	18546050
		CN 6-0	68 1/4" (1734)	18546055
		CN7-6 OOX, XOO	85 3/4" (2178)	18546079
		CN7-6 OXO LH***	27 1/2" (699)	18546076
		CN7-6 OXO RH***	27 1/2" (699)	18546077
		CN 9-0 OOX, XOO	103 3/4" (2635)	18546096
		CN 9-0 OXO LH**	33 1/2" (851)	18546092
		CN 9-0 OXO RH**	33 1/2" (851)	18546094

* Arctic White was the standard 1/1997-2/2002.
 ** Requires both the 9-0 OXO and the 6-0 part
 *** Requires both the 7-6 OXO and the 5-0 part

Elevate Sliding Patio Door Disc LA PRE 02-25-2019

When ordering replacement vinyl and weatherstrip specify:

1. Quantity;
2. Profile number;
3. Part number;
4. Size;
5. Description.

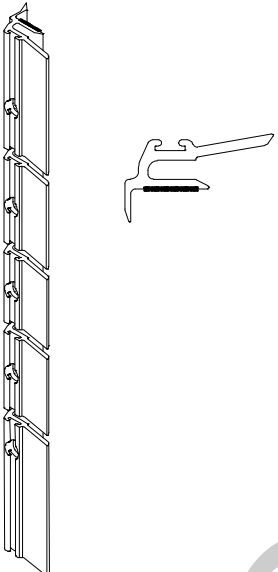
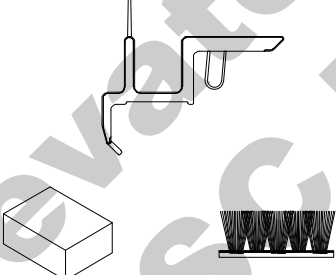
ILLUSTRATION NOT TO SCALE	DESCRIPTION	LENGTH/ COLOR	PART NO.
 <p>NOTE: Adhesive tape included</p>	<p>Interlock, Stationary (Option 1) V009</p> <p>Available replacement screws: 14 - #8 x 1" self tapping beige Phillips pan head screws (11800819)</p> <p>Pile Weather Strip is not included (11107546)</p> <p>CN 6-5 XO height CN 6-5 OX height CN 6-8 XO height CN 6-8 OX height</p>	<p>Beige</p> <p>77 3/16" (1961) 77 3/16" (1961) 79 11/16" (2024) 79 11/16" (2024)</p>	<p>15917665 15917666 15917668 15917669</p>
	<p>Interlock, Operator (Option 1) V009</p> <p>Available replacement screws: 14 - #8 x 5/8" self tapping Phillips pan head screws (11800505)</p> <p>Pile Weather Strip is not included (15607569)</p> <p>CN 6-5 XO height CN 6-5 OX height CN 6-8 XO height CN 6-8 OX height</p>	<p>Beige</p> <p>77" (1956) 77" (1956) 79 1/2" (2019) 79 1/2" (2019)</p>	<p>15916265 15916266 15916268 15916269</p>
	<p>Interlock Replacement Kit (Option 2) Includes: 1 - V2952 Operator Interlock, Beige 1 - V2952 Stationary Interlock, Beige 16 - #8 x 1" Type-A Phillips pan head screws 1 - Panel drip plug 2 - Sill dust block 1 - Interlock Retrofit Service Instruction</p>		<p>116633</p>

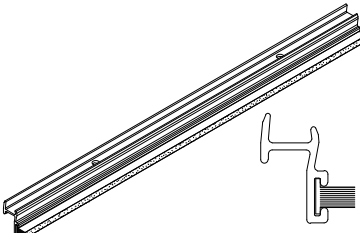
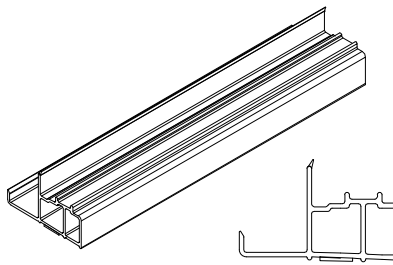
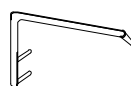
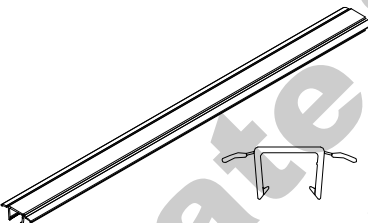
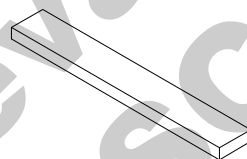


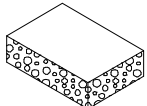
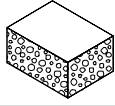


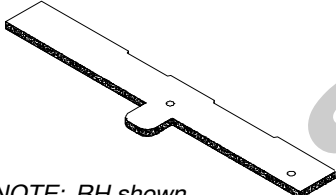
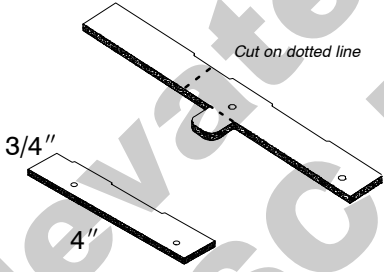
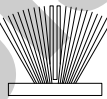
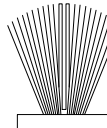
ILLUSTRATION NOT TO SCALE	DESCRIPTION	LENGTH/COLOR	PART NO.
 <p>NOTE: Weatherstrip included</p>	<p>Panel Drip Seal V010</p> <p>Available replacement screws: 6 – #7 x 1/2" Phillips self tapping pan head screws 11800756</p> <p>CN 5-0/7-6 width CN 6-0/9-0 width</p>	<p>Beige</p> <p>29 5/8" (752) 35 5/8" (905)</p>	<p>15936350 15936355</p>
 <p>NOTE: Adhesive tape included</p>	<p>Stationary Panel Leveling Block V008</p> <p>Available replacement screws: 1 – #8 x 3/4" self tapping truss head Almond Frost screws (OX, XO) 11800833 3 – #8 x 3/4" self tapping truss head Almond Frost screws (OOX, XOO, OXO) 11800833</p> <p>CN 5-0/7-6 OXO width CN 6-0/9-0 OXO width CN 7-6 OOX, XOO width CN 9-0 OOX, XOO width</p>	<p>Beige</p> <p>29 19/32" (752) 35 19/32" (904) 59 9/32" (1506) 71 9/32" (1811)</p>	<p>15916750 15916755 15916776 15916795</p>
	<p>Astragal Stile Cap* V2649 80 1/2" (2045)</p> <p>NOTE: For OXO door configurations NOTE: AR is no longer available, order SW.</p>	<p>Stone White Pebble Bronze Evergreen Cashmere Ebony Arctic White</p>	<p>15910131 15910132 15910133 15910134 15910135 15910137 N/A</p>
	<p>Jamb/Head Jamb Frame Weather Strip V2396</p> <p>NOTE: Parts will need to be fabricated in the field.</p>	<p>Beige</p> <p>68 57/64" (1750) 78 11/16" (1999) 82 11/16" (2100) 114 25/64" (29054)</p>	<p>15981160 15977168 15977170 15978010</p>
	<p>Frame Sealant, Foam, Sill Liner 1/16" x 3/8" Adhesive backed</p>	<p>Gray (specify length)</p>	<p>10500142</p>

ILLUSTRATION NOT TO SCALE	DESCRIPTION	LENGTH/ COLOR	PART NO.
	Sill Dust Block 2" x 13/16" x 5" <i>NOTE: Adhesive backed</i>	Gray	10500132
	Head Jamb Dust Block 2 5/16" x 5/8" x 1/2" <i>NOTE: Adhesive backed</i>	Gray	10500135
	Jamb / Sill Plug 1 1/8" x 25/32" x 5/16" <i>NOTE: Adhesive backed</i>	Beige	10500136
	Panel Drip Plug 3/4" x 19/32" x 3/8" <i>NOTE: Adhesive backed</i>	Gray	10500137
	Astragal Plug 1" x 1/2" x 11/16"	Beige	10500152
	Head Jamb to Stationary Panel Foam Plug	Beige	10500128
 <i>NOTE: RH shown</i>	Sill to Jamb Gasket 3/4" x 6 3/8" x 3/4" x 1/8" <i>NOTE: Adhesive backed</i> <i>NOTE: Left and right hand supplied.</i>	Gray	10500140
 <i>Cut on dotted line</i> 3/4" 4"	Astragal Gasket 3/4" x 4" x 1/8" <i>NOTE: The adhesive backed astragal gasket is formed from the sill to jamb gasket by cutting the gasket to the dimensions shown in the illustration.</i>	Gray	10500140
	Panel Drip Weather Strip 17/64" x 1/4" pile weatherstrip with fin	Gray (specify length)	15607525
	Stationary and Operator Panel Interlock Weather Strip 17/64" x 15/32" pile weatherstrip with fin	Beige (specify length)	11107546

When ordering replacement wood parts specify:

1. Part number;
2. Size;
3. Description.
4. Handing (if applicable)
5. Bare wood or white interior.

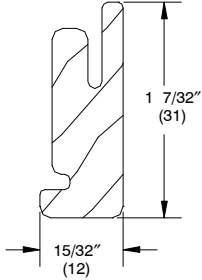
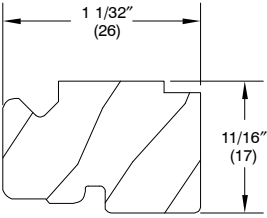
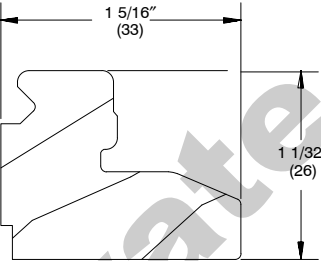
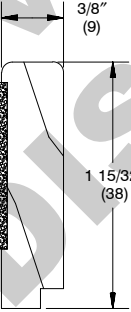

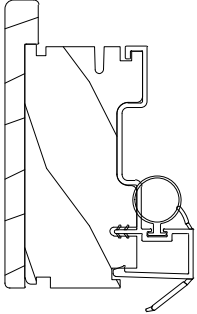

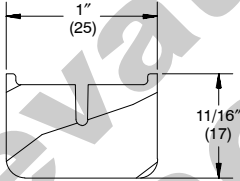
ILLUSTRATION <i>NOT TO SCALE</i>	DESCRIPTION	LENGTH	BARE WOOD PART NO.	WHITE INTERIOR PART NO.
	<p>Operator Panel Guide W8566 Usage dates: 11/2003 to present.</p> <p>CN 5-0 width CN 6-0 width CN 7-6 width CN 9-0 width</p>	<p>56 3/8" (1432) 68 3/8" (1737) 86 1/2" (2197) 103 13/16" (2637)</p>	<p>31518750 31518755 31518776 31518792</p>	<p>39228750 39228755 39228776 39228792</p>
	<p>Head Jamb Liner W8565 Usage dates: 11/2003 to present</p> <p>CN 5-0 width CN 6-0 width CN 7-6 width CN 9-0 width Replacement length</p>	<p>58 7/8" (1495) 70 7/8" (1800) 88 3/8" (2245) 106 3/8" (2702) 116 7/8" (2702)</p>	<p>31518650 31518655 31518676 31518695 31518610</p>	<p>39228650 39228655 39228676 39228695 39228676</p>
	<p>Jamb Liner W7623 <i>NOTE: Handing is from the exterior</i></p> <p>CN 6-5 RH CN 6-5 LH CN 6-8 RH CN 6-8 LH</p>	<p>79 1/16" (2008) 79 1/16" (2008) 81 9/16" (2072) 81 9/16" (2072)</p>	<p>31505365 31505366 31505368 31505369</p>	<p>39205365 39205366 39205368 39205369</p>
	<p>Oak Sill Liner W6275 <i>NOTE: Adhesive tape included.</i> <i>Available replacement screws:</i> 2 - #8 x 1 1/2" Phillips self tapping pan head screws 11865161 2 - #8 x 5/8" Phillips pan head screws 11800505</p> <p>CN 5-0 width CN 6-0 width CN 7-6 width CN 9-0 width</p>	<p>58 7/8" (1495) 70 7/8" (1800) 88 3/8" (2245) 106 3/8" (2702)</p>	<p>31505050 31505055 31505076 31505095</p>	

ILLUSTRATION <i>NOT TO SCALE</i>	DESCRIPTION	LENGTH	BARE WOOD PART NO.	WHITE INTERIOR PART NO.
	Stationary Panel Spacer W8581	12" (305)	31518812	
	Astragal Assembly - OXO <i>NOTE: Replaces discontinued profiles W7716 and 7718</i> <i>Includes:</i> 1 - Astragal 1 - Astragal cover 1 - Weather strip 1 - Top gasket 1 - Bottom gasket 1 - Bulb weather strip <i>Available replacement screws: suggested quantity - 9 #8 x 3 1/2" screws (05080126)</i>			
	Astragal Trim W7718 <i>NOTE: Connecting barb (V803) included.</i> <i>NOTE: For OXO configurations.</i>			
	Interior Mullion Trim W7719 <i>NOTE: For XOO or OOX configurations</i>			
	CN 6-5 height LH CN 6-5 height RH CN 6-8 height LH CN 6-8 height RH	77 37/64" (1971) 77 37/64" (1971) 80 5/64" (2034) 80 5/64" (2034)	10826503 10826504 10826803 10826804	10826501 10826502 10826801 10826802
	CN 6-8 height	78 13/16" (2002)	31506568	39206568
	CN 6-8 height	79 3/4" (2026)	31506668	39206668

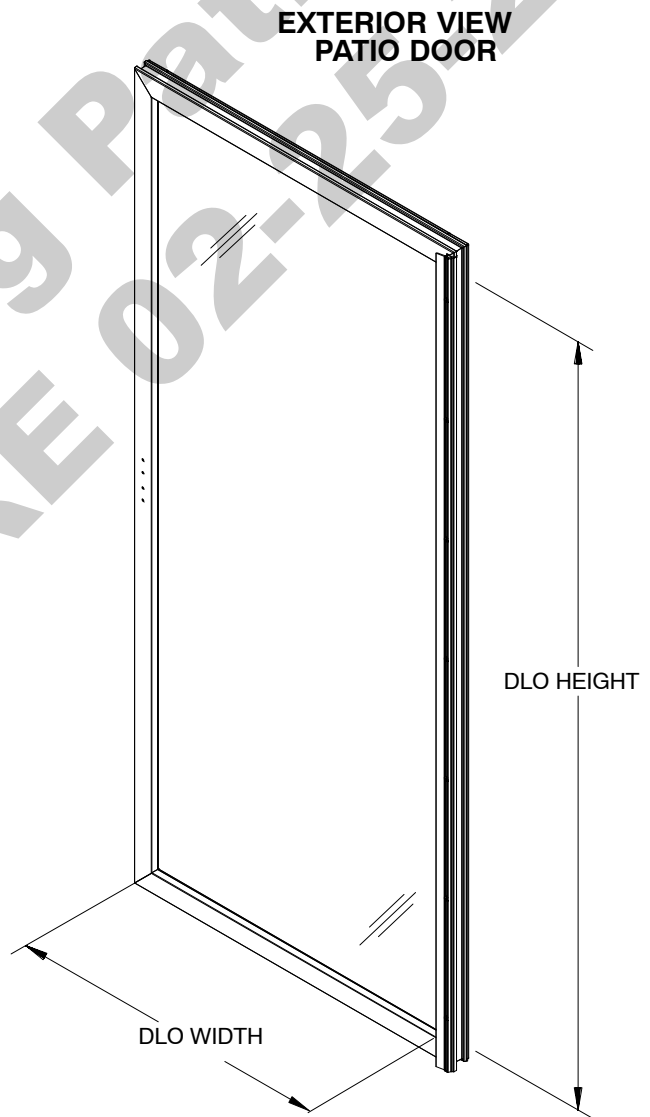
ORDERING REPLACEMENT ELEVATE SLIDING PATIO DOOR PANELS

To order replacement panels specify:

1. Size; (verify manufacture date before ordering)
2. Operator or stationary;
3. Handing;
4. Stone White, Pebble Gray, Bronze, Evergreen, Cashmere, Ebony or Arctic White exterior;
5. Glazing;
6. Bare wood or white interior.

Elevate Patio Door (IPD) Replacement Panels			
Units Manufactured 1997 to March 1, 2004			
Daylight Opening to Panel OM			
Daylight Width + 4 5/8" (117) = OM Width of Panel			
Daylight Height + 4 5/8" = OM Height of Panel			
WIDTH		HEIGHT	
SIZE	OM WIDTH	SIZE	OM HEIGHT
5-0	29 5/8" (752)	6-5	77 3/16" (1961)
6-0 retro	35 5/8" (905)	6-8	79 11/16" (2024)
6-0	36 1/8" (918)		
9-0	36 1/8" (918)		

Elevate Sliding Patio Door Replacement (ELPD) Panels			
Units Manufactured March 1, 2004 to Present			
Daylight Opening to Panel OM			
Daylight Width + 4 5/8" = OM Width of Panel			
Daylight Height + 4 5/8" = OM Height of Panel			
WIDTH		HEIGHT	
SIZE	OM WIDTH	SIZE	OM HEIGHT
5-0	29 5/8"	6-5	77 3/16"
6-0	35 5/8"	6-8	79 11/16"
7-6	29 5/8"		
9-0	35 5/8"		



NOTE: Operator panels include rollers, panel drip with plug, and interlock. Stationary panels include interlock and panel spacers. The daylight opening is the measurement of visible glass.

ORDERING SLIDING REPLACEMENT SCREENS

Screens are standard with a color matched aluminum surround and charcoal colored fiberglass 18 x 16 screen mesh. Determine the outside measurement of the existing screen. Find the sizes that correspond to the width and height indicated on the following chart.

When ordering replacement screen specify:

1. Size; if there is no existing screen from which to obtain the OM of the screen, determine the size of the screen by using the conversion chart below. The daylight opening is the measurement of the visible glass.
2. Handing;




Screen Sizes for Patio Door (IPD) manufactured 1997 to May 5, 2003			
Daylight Opening to OM of Screen			
Daylight Width +4 3/16" (106) = OM Width of Screen			
Daylight Height +4" (102) = OM Height of Screen			
WIDTH		HEIGHT	
SIZE	OM WIDTH	SIZE	OM HEIGHT
5-0	29 3/16" (741)	6-5	76 19/32" (1975)
6-0 retro	35 3/16" (894)	6-8	79 3/32" (2038)
6-0	35 11/16" (906)		
9-0	35 11/16"		

Screen Sizes for Patio Door (IPD) manufactured May 5, 2003 to March 1, 2004			
Daylight Opening to OM of Screen			
Daylight Width +4 3/16" (106) = OM Width of Screen			
Daylight Height +5 3/16" (132) = OM Height of Screen			
WIDTH		HEIGHT	
SIZE	OM WIDTH	SIZE	OM HEIGHT
5-0	29 3/16"	6-5	77 3/4" (1975)
6-0 retro	35 3/16"	6-8	80 1/4" (2038)
6-0	35 11/16"		
9-0	35 11/16"		

Screen Sizes for Sliding Patio Door (ELPD) manufactured March 1, 2004 to Present			
Daylight Opening to OM of Screen			
Daylight Width +4 3/16" (106) = OM Width of Screen			
Daylight Height +5 3/16" (132) = OM Height of Screen			
WIDTH		HEIGHT	
SIZE	OM WIDTH	SIZE	OM HEIGHT
5-0	29 3/16"	6-5	77 3/4"
6-0	35 3/16"	6-8	80 1/4"
7-6	29 3/16"		
9-0	35 3/16"		

ATTENTION: The Elevate Patio Door screen profile changed between February 2002 and May 2003.

- White screen profiles changed on 2/4/2002, along with a color change from Arctic White to Stone White. The roller bar (A213) and screen track (A214) were still used.
- On 5/6/2003 Stone White and Pebble screens changed to the new profile but use an integral roller bar instead of the old A213 roller bar and A214 screen track.
- All screen tracks can be replaced with the current head jamb screen track, A1237.
- Refer to illustrations below to identify screen type.

Pre 2/4/02	2/4/02 to 5/5/03	5/6/03 to Present
		

When ordering Sliding Patio Door replacement screen parts specify:

1. Description;
2. Part number;
3. Quantity.

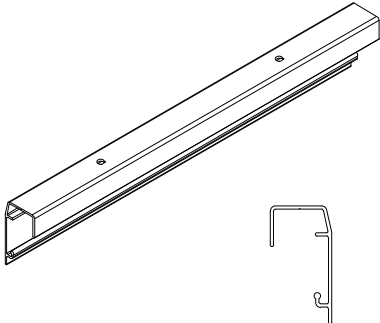
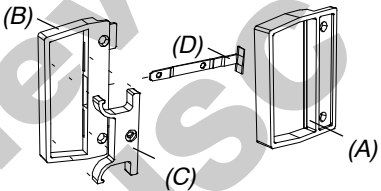
ILLUSTRATION <i>NOT TO SCALE</i>	DESCRIPTION	COLOR	PART NO.
	<p>Head Jamb Screen Track A1237 <i>Includes:</i> 1 - Head jamb screen track 6 - #8x5/8" Pierce point, Phillips, truss head screws 11800862</p>		
	<p>CN 5-0/CN 7-6 OXO 57 17/32" (1461)</p>	<p>Stone White Pebble Bronze Evergreen Cashmere Ebony</p>	<p>11897145 11897146 11897147 11897148 11897149 11898150</p>
	<p>CN 6-0/CN 9-0 OXO 69 17/32" (1766)</p>	<p>Stone White Pebble Bronze Evergreen Cashmere Ebony</p>	<p>11897150 11897151 11897152 11897153 11897154 11898155</p>
	<p>CN 7-6 OOX, XOO 87 1/32" (2211)</p>	<p>Stone White Pebble Bronze Evergreen Cashmere Ebony</p>	<p>10870476 10870576 10870676 10870767 10870867 10870967</p>
	<p>CN 9-0 OOX, XOO 105 1/32" (2668)</p>	<p>Stone White Pebble Bronze Evergreen Cashmere Ebony</p>	<p>11897160 11897161 11897162 11897163 11897164 11898165</p>
	<p>Screen Handle Assembly <i>Includes:</i> 1 - Exterior handle (A) 1 - Interior handle (B) 1 - Slide (C) 1 - Latch (D) 3 - Screws 1 - Rivet</p>	<p>Black</p>	<p>10150028</p>

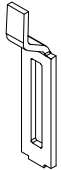
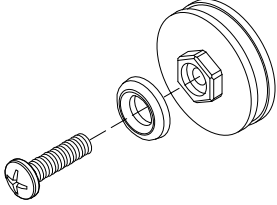


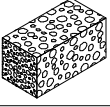
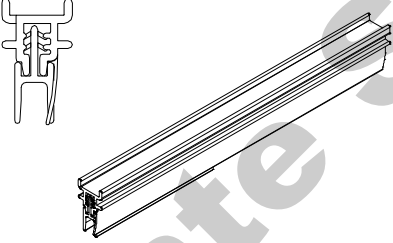

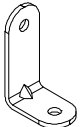
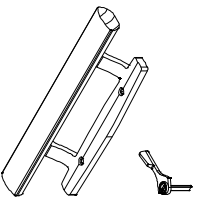
ILLUSTRATION NOT TO SCALE	DESCRIPTION	LENGTH/ COLOR	PART NO.
	<p>Door Strike <i>Available replacement screws::</i> 1 – #8 x 5/8" Phillips pan head screw 11800505</p>		02100963
	<p>Screen Roller Assembly <i>Includes:</i> 2 – Rollers 2 – Machine screws 2 – Grommet washers</p>		11869525
	<p>Screen Roller Track Dust Block 7/8" x 7/8" x 3/16" <i>NOTE: Adhesive backed, located behind the screen roller bar</i></p>	Gray	10500143
	<p>Screen Door Meeting Stile Dust Block 17/32" x 7/8" x 1/2" <i>NOTE: Adhesive backed</i></p>	Gray	10500161
	<p>Screen Bumper 3/4" x 3/4" x 1 3/8"</p>	White	02540675
	<p>Screen Roller Guide Assembly</p>	CN 5-0/7-6 CN 6-0/9-0	15918050 15918060
	<p>Screen Roller Guide V2241</p>	Beige 2" (51)	15918002

ILLUSTRATION NOT TO SCALE	DESCRIPTION	COLOR	PART NO.
	90 Degree Angle Bracket		Discontinued (replace with 10500131)
	Interior Handle w/ Turn Lever Used for product 1/1997 – 4/2001		Discontinued

Elevate Sliding Patio Door
DISC LA PRE 02-25-2019

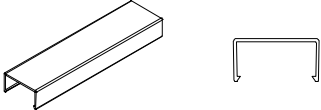
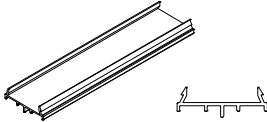
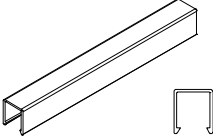
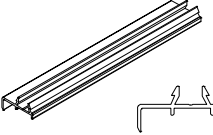
ILLUSTRATION NOT TO SCALE	DESCRIPTION	LENGTH/COLOR	PART NO.
	<p>Mullion Cap* A364 NOTE: For OOX or XOO door configurations NOTE: A364 can be replaced with A3337 Spline shown in the current Elevate Sliding Patio chapter. Use part numbers in the closest longer length.</p>	Stone White Pebble Bronze Evergreen Cashmere Ebony	Replace with A3337 Spline. See note in description column.
	<p>Mullion Cap Base* A363 NOTE: A364 can be replaced with A3337 Spline shown in the current Elevate Sliding Patio chapter. Use part numbers in the closest longer length.</p>	Stone White Pebble Bronze Evergreen Cashmere Ebony	Replace with A3337 Spline. See note in description column.
	<p>Screen Stop Astragal Cap* A361 NOTE: A364 can be replaced with A1222 Stile Cover shown in the current Elevate Sliding Patio chapter. Use part numbers in the closest longer length.</p>	Stone White Pebble Bronze Evergreen Cashmere Ebony	Replace with A1222 Stile Cover. See note in description column.
	<p>Screen Stop Astragal Base* A362 NOTE: For OXO door configurations NOTE: A364 can be replaced with A3218 Screen Stop Base shown in the current Elevate Sliding Patio chapter. Use part numbers in the closest longer length.</p>	Stone White Pebble Bronze Evergreen Cashmere Ebony	Replace with A3218 Screen Stop Base. See note in description column.
		Arctic White	No longer available

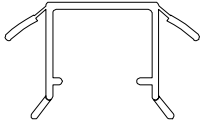
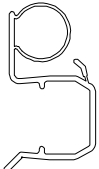
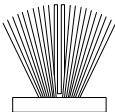
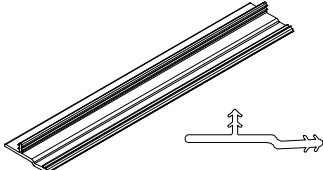
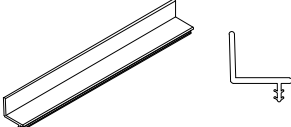
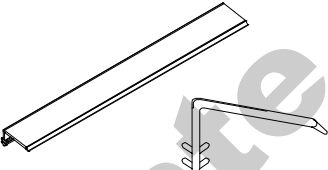
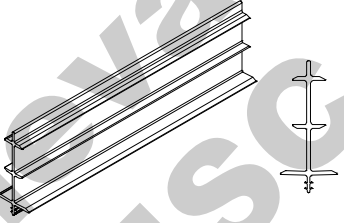
ILLUSTRATION NOT TO SCALE	DESCRIPTION	Part Number
	Head Jamb Parting Stop Weather Strip V735	Beige Discontinued Replace with V2396 in closest longer length
	Stationary Jamb Parting Stop Weather Strip V735	
	Operator Jamb Parting Stop Weather Strip V011	
	Operator Panel Interlock Weather Strip 17/64" x 13/32" pile weatherstrip with fin	Beige Discontinued Replace with 11107546
	Panel Guide Connector V016 Usage: 7/1997 – 3/2004	Discontinued Replace with A1223
	Panel Guide Fastener V015 Replaced with V016	Discontinued Replace with A1223
	Astragal Stile Cap V925 80 1/2" (2045) NOTE: For OOX or XOO door configurations	Arctic White is no longer available Replace V2649 in Stone White
	Panel Spline V924 NOTE: V924 can be replaced with V2638 Spline Insert shown in the current Elevate Sliding Patio chapter. Use part numbers in the closest longer length.	Replace with V2638 Spline Insert. See note in description column.

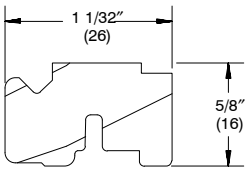
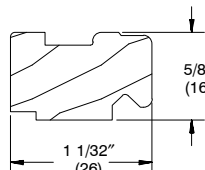
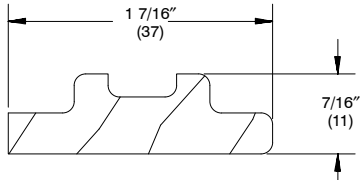
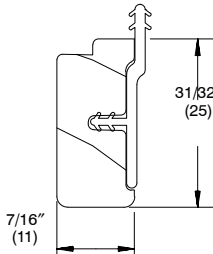
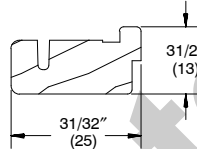
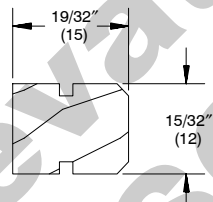
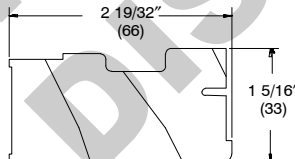
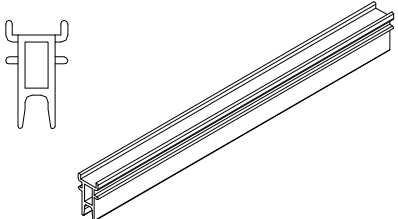
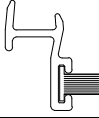
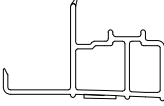

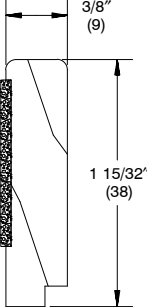
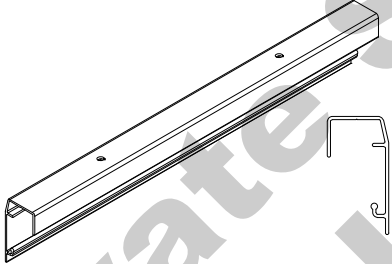
ILLUSTRATION NOT TO SCALE	DESCRIPTION	LENGTH	BARE WOOD PART NO.	WHITE INTERIOR PART NO.
	<p>Head Jamb Liner W7709 Usage dates: 1/1997 – 11/2003</p>		Discontinued Replace with W8565	
	<p>Head Jamb Liner W7624</p>		Discontinued Replace with W8565	
	<p>Stationary Panel Spacer W7626</p>	12" (305)	Discontinued Replace with W8581	
	<p>Operator Panel Guide W7710 Usage dates: 1/1997 – 11/2003</p>		Discontinued Replace with W8566	
	<p>Operator Panel Guide W7625</p>		Discontinued Replace with W7710	
	<p>Astragal Parting Stop W7716 NOTE: For OXO configurations</p>		Discontinued Replace both W7716 and W7717 with the Astragal Assembly shown in the wood parts section earlier in the chapter.	
	<p>Astragal W7717 NOTE: For OXO configurations – handling is from the exterior</p>			

ILLUSTRATION NOT TO SCALE	DESCRIPTION	LENGTH/ COLOR	PART NO.
	<p>Screen Roller Guide V014</p>		<p>Discontinued – Replace with Screen Roller Guide Assembly</p>

Elevate Sliding Patio Door
 DISC LA PRE 02-25-2019

ATTENTION: This section contains part and part numbers for current parts whose length changed due to the March 1, 2004 door size change. Obsolete parts can be found in the previous section. For more detailed descriptions of these parts, see the main parts sections.

ILLUSTRATION NOT TO SCALE	DESCRIPTION	LENGTH	PART NO.
	V010 Panel Drip Seal (A) CN 6-0/9-0 width	36 1/8" (918)	15916360
	V008 Stationary Panel Leveling Block CN 6-0/9-0 width CN /9-0 OOX, XOO width	36 1/8" (918) 36 11/16" (906)	15916760 15916790
	Stainless Steel Sill Cap (C) CN 6-0/9-0 width CN /9-0 OOX, XOO width	71" (894) 107" (1803)	10500160 10500190
	Oak Sill Liner W6275 – Used pre-3/2004 CN 6-0 width	71 7/8" (1826)	31505060
	Head Jamb Screen Track A1237 CN 6-0 SW CN 6-0 PB CN 9-0 SW CN 9-0 PB	70 17/32" (1792) 106 17/32" (2706)	18547260 18547360 18547290 18547390

ATTENTION: This section contains part and part numbers for current parts whose length changed due to the March 1, 2004 door size change. Obsolete parts can be found in the previous section. For more detailed descriptions of these parts, see the main parts sections.

ILLUSTRATION <i>NOT TO SCALE</i>	DESCRIPTION	
	Head Jamb Parting Stop Weather Strip V735	Discontinued Replace with V2396 (See Pre 02/25/2019 Weather Strip section for available replacement parts)

Elevate Sliding Patio Door
 DISC LA PRE 02-25-2019