













































# DOUBLE HUNG PICTURE ROUND TOP G2

RT6 PICTURE EYEBROW ABOVE SPRINGLINE

RO (mm)	3-6 1/4 (1073)	4-2 1/4 (1276)	4-6 1/4 (1378)	5-2 1/4 (1581)	5-10 1/4 (1784)
RO Rad. (mm)	3-4 1/2 (1029)	3-4 1/2 (1029)	4-6 1/2 (1384)	6-0 1/2 (1842)	6-0 1/2 (1842)
RO (mm)	3-9 47/64 (1161)	4-0 31/64 (1231)	3-11 1/64 (1194)	3-10 27/32 (1190)	4-0 7/8 (1241)
RO Spih. (mm)	3-3 25/32 (1010)	3-3 3/4 (1009)	3-3 51/64 (1011)	3-3 13/16 (1011)	3-3 51/64 (1011)
					
	UDHPRTG2 4038	UDHPRTG2 4838	UDHPRTG2 5238	UDHPRTG2 6038	UDHPRTG2 6838
RO (mm)	4-1 47/64 (1263)	4-4 31/64 (1333)	4-3 1/64 (1296)	4-2 27/32 (1291)	4-4 7/8 (1343)
RO Spih. (mm)	3-7 25/32 (1112)	3-7 3/4 (1111)	3-7 51/64 (1112)	3-7 13/16 (1113)	3-7 51/64 (1112)
					
	UDHPRTG2 4042	UDHPRTG2 4842	UDHPRTG2 5242	UDHPRTG2 6042	UDHPRTG2 6842
RO (mm)	4-5 47/64 (1365)	4-8 31/64 (1435)	4-7 1/64 (1398)	4-6 27/32 (1393)	4-8 7/8 (1445)
RO Spih. (mm)	3-11 25/32 (1214)	3-11 3/4 (1213)	3-11 51/64 (1214)	3-11 13/16 (1215)	3-11 51/64 (1214)
					
	UDHPRTG2 4046	UDHPRTG2 4846	UDHPRTG2 5246	UDHPRTG2 6046	UDHPRTG2 6846
RO (mm)	4-9 47/64 (1466)	5-0 31/64 (1536)	4-11 1/64 (1499)	4-10 27/32 (1494)	5-0 7/8 (1546)
RO Spih. (mm)	4-3 25/32 (1315)	4-3 3/4 (1314)	4-3 51/64 (1315)	4-3 13/16 (1316)	4-3 51/64 (1316)
					
	UDHPRTG2 4050	UDHPRTG2 4850	UDHPRTG2 5250	UDHPRTG2 6050	UDHPRTG2 6850
RO (mm)	5-1 47/64 (1568)	5-4 31/64 (1638)	5-3 1/64 (1601)	5-2 27/32 (1596)	5-4 7/8 (1648)
RO Spih. (mm)	4-7 25/32 (1417)	4-7 3/4 (1416)	4-7 51/64 (1417)	4-7 13/16 (1418)	4-7 51/64 (1417)
					
	UDHPRTG2 4054	UDHPRTG2 4854	UDHPRTG2 5254	UDHPRTG2 6054	UDHPRTG2 6854
RO (mm)	5-5 47/64 (1669)	5-8 31/64 (1739)	5-7 1/64 (1702)	5-6 27/32 (1698)	5-8 7/8 (1749)
RO Spih. (mm)	4-11 25/32 (1518)	4-11 3/4 (1517)	4-11 51/64 (1519)	4-11 13/16 (1519)	4-11 51/64 (1519)
					
	UDHPRTG2 4058	UDHPRTG2 4858	UDHPRTG2 5258	UDHPRTG2 6058	UDHPRTG2 6858
RO (mm)	5-9 47/64 (1771)	6-0 31/64 (1841)	5-11 1/64 (1804)	5-10 27/32 (1799)	6-0 7/8 (1851)
RO Spih. (mm)	5-3 25/32 (1620)	5-3 3/4 (1619)	5-3 51/64 (1620)	5-3 13/16 (1621)	5-3 51/64 (1620)
					
	UDHPRTG2 4062	UDHPRTG2 4862	UDHPRTG2 5262	UDHPRTG2 6062	UDHPRTG2 6862
RO (mm)	6-1 47/64 (1873)	6-4 31/64 (1943)	6-3 1/64 (1906)	6-2 27/32 (1901)	6-4 7/8 (1953)
RO Spih. (mm)	5-7 25/32 (1722)	5-7 3/4 (1721)	5-7 51/64 (1722)	5-7 13/16 (1723)	5-7 51/64 (1722)
					
	UDHPRTG2 4066	UDHPRTG2 4866	UDHPRTG2 5266	UDHPRTG2 6066	UDHPRTG2 6866
RO (mm)	6-5 47/64 (1974)	6-8 31/64 (2044)	6-7 1/64 (2007)	6-6 27/32 (2002)	6-8 7/8 (2054)
RO Spih. (mm)	5-11 25/32 (1823)	5-11 3/4 (1822)	5-11 51/64 (1823)	5-11 13/16 (1824)	5-11 51/64 (1824)
					
	UDHPRTG2 4070	UDHPRTG2 4870	UDHPRTG2 5270	UDHPRTG2 6070	UDHPRTG2 6870

# DOUBLE HUNG PICTURE ROUND TOP G2

## RT6 PICTURE EYEBROW ABOVE SPRINGLINE

RO (mm)	3-6 1/4 (1073)	4-2 1/4 (1276)	4-6 1/4 (1378)	5-2 1/4 (1581)	5-10 1/4 (1784)
RO Rad. (mm)	3-4 1/2 (1029)	3-4 1/2 (1029)	4-6 1/2 (1384)	6-0 1/2 (1842)	6-0 1/2 (1842)
RO (mm)	6-9 47/64 (2076)	7-0 31/64 (2146)	6-11 1/64 (2109)	6-10 27/32 (2104)	7-0 7/8 (2516)
RO Sph. (mm)	6-3 25/32 (1925)	6-3 3/4 (1924)	6-3 51/64 (1925)	6-3 13/16 (1926)	6-3 51/64 (1925)
	UDHPRTG2 4074	UDHPRTG2 4874	UDHPRTG2 5274	UDHPRTG2 6074	UDHPRTG2 6874
RO (mm)	7-1 47/64 (2177)	7-4 31/64 (2247)	7-3 1/64 (2210)	7-2 27/32 (2206)	7-4 7/8 (2257)
RO Sph. (mm)	6-7 25/32 (2026)	6-7 3/4 (2025)	6-7 51/64 (2027)	6-7 13/16 (2027)	6-7 51/64 (2027)
	UDHPRTG2 4078	UDHPRTG2 4878	UDHPRTG2 5278	UDHPRTG2 6078	UDHPRTG2 6878
RO (mm)	7-9 47/64 (2381)	8-0 31/64 (2451)	7-3 1/64 (2414)	7-10 27/32 (2409)	
RO Sph. (mm)	7-3 25/32 (2230)	7-3 3/4 (2229)	7-3 51/64 (2230)	7-3 13/16 (2231)	
	UDHPRTG2 4086	UDHPRTG2 4886	UDHPRTG2 5286	UDHPRTG2 6086	
RO (mm)	8-1 47/64 (2482)	8-4 31/64 (2552)	8-3 1/64 (2515)	8-2 27/32 (2510)	
RO Sph. (mm)	7-7 25/32 (2331)	7-7 3/4 (2330)	7-7 51/64 (2331)	7-7 13/16 (2332)	
	UDHPRTG2 4090	UDHPRTG2 4890	UDHPRTG2 5290	UDHPRTG2 6090	
RO (mm)					
RO Sph. (mm)					

### CONSTRUCTION DETAILS

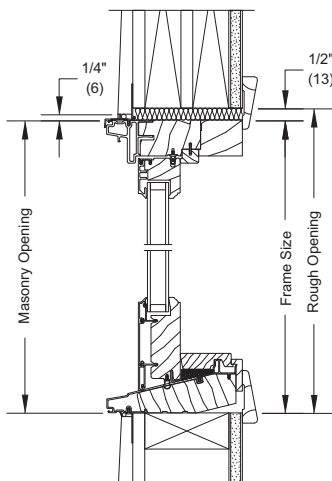

HEAD JAMB AND SILL - PICTURE

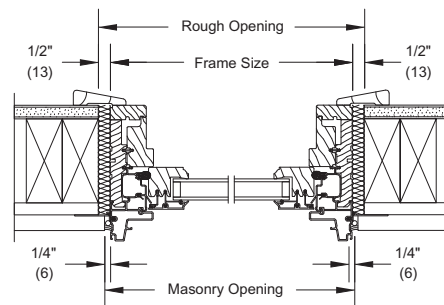

JAMB - PICTURE

Ultimate Double Hung Picture Round Top G2: UDHPRTG2