















































DOUBLE HUNG PICTURE G2

MO (mm)	3-5 3/4 (1060)	4-1 3/4 (1264)	4-5 3/4 (1365)	5-1 3/4 (1568)	5-9 3/4 (1772)
RO (mm)	3-6 1/4 (1073)	4-2 1/4 (1276)	4-6 1/4 (1378)	5-2 1/4 (1581)	5-10 1/4 (1784)
FS (mm)	3-5 1/4 (1048)	4-1 1/4 (1251)	4-5 1/4 (1353)	5-1 1/4 (1556)	5-9 1/4 (1759)
DLO (mm)	34 47/64 (882)	42 47/64 (1085)	46 47/64 (1187)	54 47/64 (1390)	62 47/64 (1594)
3-3 3/4 (1010) 3-4 (1016) 3-3 1/2 (1003) 3-1 27/64 (798)	 UDHPG2 4038	 UDHPG2 4838	 UDHPG2 5238	 UDHPG2 6038	 UDHPG2 6838
3-7 3/4 (1111) 3-8 (1118) 3-7 1/2 (1105) 3-5 27/64 (900)	 UDHPG2 4042	 UDHPG2 4842	 UDHPG2 5242	 UDHPG2 6042	 UDHPG2 6842
4-0 5/8 (1235) 4-0 (1219) 3-11 1/2 (1207) 3-9 27/64 (1001)	 UDHPG2 4046	 UDHPG2 4846	 UDHPG2 5246	 UDHPG2 6046	 UDHPG2 6846
4-4 5/8 (1337) 4-4 (1321) 4-3 1/2 (1308) 4-3 27/64 (1103)	 UDHPG2 4050	 UDHPG2 4850	 UDHPG2 5250	 UDHPG2 6050	 UDHPG2 6850
4-8 5/8 (1438) 4-8 (1422) 4-7 1/2 (1410) 4-7 27/64 (1204)	 UDHPG2 4054	 UDHPG2 4854	 UDHPG2 5254	 UDHPG2 6054	 UDHPG2 6854
5-0 5/8 (1540) 5-0 (1524) 4-11 1/2 (1511) 5-1 27/64 (1306)	 UDHPG2 4058	 UDHPG2 4858	 UDHPG2 5258	 UDHPG2 6058	 UDHPG2 6858
5-4 5/8 (1641) 5-4 (1626) 5-3 1/2 (1613) 5-3 27/64 (1408)	 UDHPG2 4062	 UDHPG2 4862	 UDHPG2 5262	 UDHPG2 6062	 UDHPG2 6862
5-8 5/8 (1743) 5-8 (1727) 5-7 1/2 (1715) 5-7 27/64 (1509)	 UDHPG2 4066	 UDHPG2 4866	 UDHPG2 5266	 UDHPG2 6066	 UDHPG2 6866
6-0 5/8 (1845) 6-0 (1829) 5-11 1/2 (1816) 6-3 27/64 (1611)	 UDHPG2 4070	 UDHPG2 4870	 UDHPG2 5270	 UDHPG2 6070	 UDHPG2 6870
6-4 5/8 (1946) 6-4 (1930) 6-3 1/2 (1918) 6-7 27/64 (1712)	 UDHPG2 4074	 UDHPG2 4874	 UDHPG2 5274	 UDHPG2 6074	 UDHPG2 6874

DOUBLE HUNG PICTURE G2

MO (mm)	3-5 3/4 (1060)	4-1 3/4 (1264)	4-5 3/4 (1365)	5-1 3/4 (1568)	5-9 3/4 (1772)
RO (mm)	3-6 1/4 (1073)	4-2 1/4 (1276)	4-6 1/4 (1378)	5-2 1/4 (1581)	5-10 1/4 (1784)
FS (mm)	3-5 1/4 (1048)	4-1 1/4 (1251)	4-5 1/4 (1353)	5-1 1/4 (1556)	5-9 1/4 (1759)
DLO (mm)	34 47/64 (882)	42 47/64 (1085)	46 47/64 (1187)	54 47/64 (1390)	62 47/64 (1594)

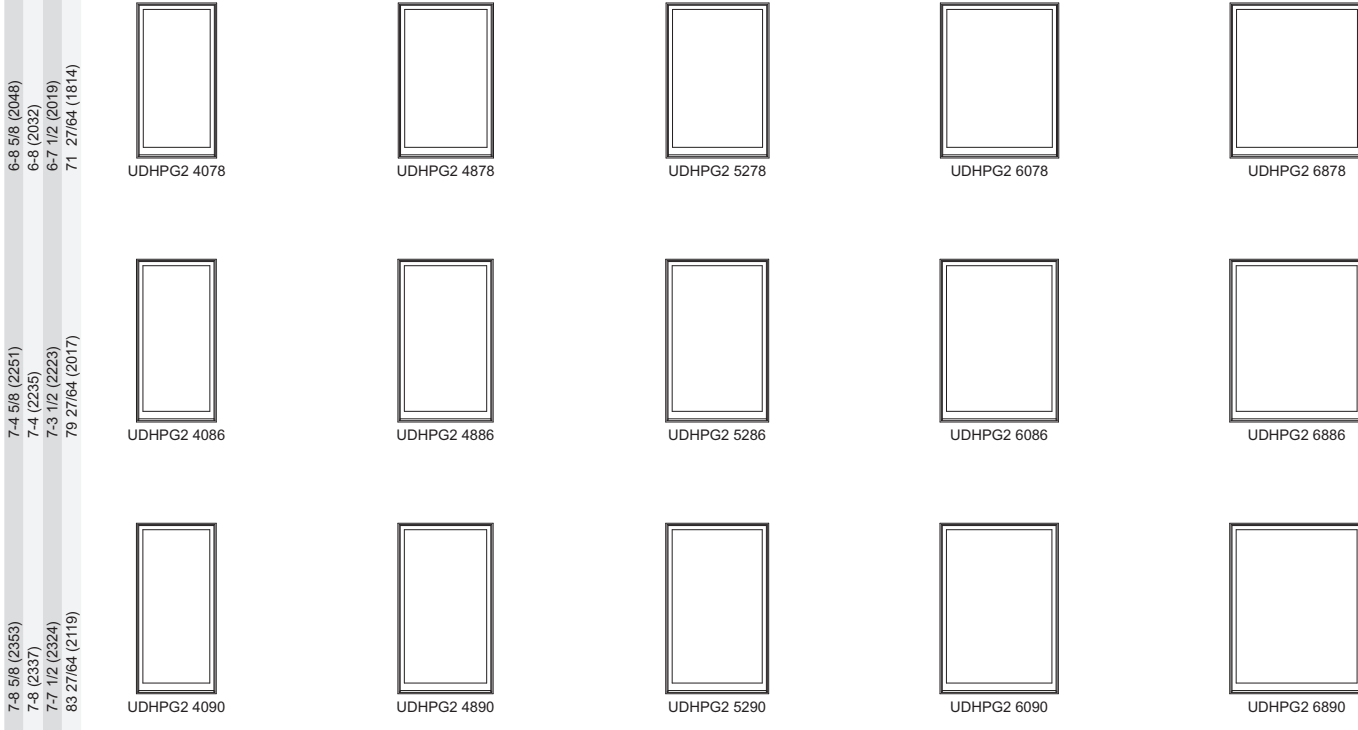

CONSTRUCTION DETAILS

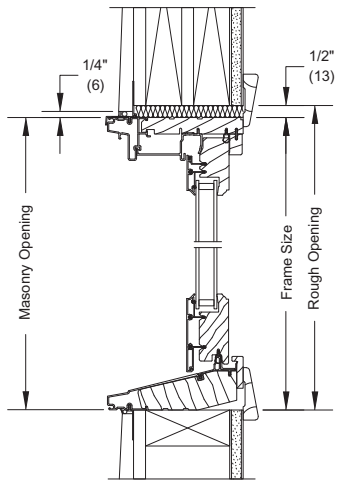

HEAD JAMB AND SILL - PICTURE

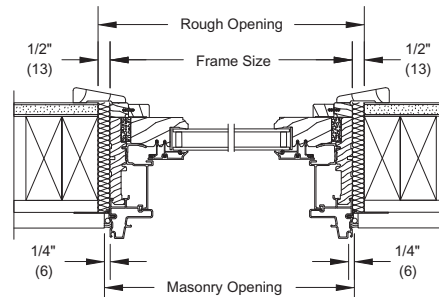

JAMB - PICTURE

Details and Elevations not to scale.

E These windows meet national Egress codes for fire evacuation. Local codes may differ.

Please consult your local Marvin representative for masonry openings that include casings and subsills.

For further details and drawings visit the 'Tools and Documents' section at Marvin.com.