

WOOD AND CLAD ULTIMATE OUTSWING FRENCH DOOR

Table of Contents

	PAGE
History	2
Part Identification – Wood Ultimate Outswing French Door XX L	5
Part Identification – Wood Ultimate Outswing French Door OO	6
Part Identification – Wood Ultimate Outswing French Door In–Sash Transom	7
Part Identification – Wood Ultimate Outswing French Door 2, 3 and 4 Panel Jamb Detail	8
Part Identification – Wood Ultimate Outswing French Door Direct Glaze Transom	9
Part Identification – Clad Ultimate Outswing French Door XX L	10
Part Identification – Clad Ultimate Outswing French Door Stationary and Sidelite	11
Part Identification – Clad Ultimate Outswing French Door In–Sash Transom	12
Part Identification – Clad Ultimate Outswing French Door 2, 3 and 4 Panel Jamb Detail	13
Part Identification – Clad Ultimate Outswing French Door Direct Glaze Transom	14
Parts – Traditional Handle – Ultimate Outswing French Doors	15
Parts – Contemporary Handle – Ultimate Outswing French Doors	18
Parts – Ultimate Outswing French Doors	20
Parts for Lock Status Sensor	26
Weather Strip and Vinyl	27
Vinyl, Aluminum or Fiberglass Parts	30
Wood Parts	31
Panel Replacement	32
Energy Panels and Parts	33
Obsolete Hardware Parts	34
Obsolete Wood Parts	47
Obsolete Weather Strip	50
Obsolete Vinyl, Aluminum and Fiberglass Parts	52
Obsolete Panel Replacement	53
Obsolete Energy Panels and Parts	54
Discontinued Weather Strip	56

ATTENTION:

- Specification and technical data are subject to change without notice.
- Numbers listed in parentheses () are metric equivalents in millimeters rounded to the nearest whole number.

HISTORY

PRODUCED	UNIT TYPE	FEATURES OR CHANGES	DISCONTINUED
1989	Wood Outswing French Door	Unit features 3/4" insulating glass, 4 9/16" jambs, 2 of the hinges feature non-removable pins, no panel bore or lock (standard). Unit offered in CN 6-8, CN 7-0 and CN 8-0 heights. Unit featured solid brass head and foot bolts and optional solid brass lever set. Sidelites and transoms introduced.	2000
1990	Clad Outswing French Door	Unit features 3/4" insulating glass, 4 9/16" jambs, 2 of the hinges feature non-removable pins, no panel bore or lock (standard), solid brass head and foot bolts and extruded aluminum glazing cap system for 1 lite and ADL insulating glass. Unit offered in CN 6-8, CN 7-0 and CN 8-0 heights. Sidelites and transoms introduced. Brown Lexan sill.	2000 2000 1991
1991	Wood and Clad Outswing French Doors	CN 6-5 height introduced including a 4 panel entrance system with continuous head jamb and sill. External component parts changed from brown to beige. Lexan sill changed from brown to beige.	2000 1994
1991	Wood and Clad Outswing	Optional multi-point (Essve) hardware system introduced.	2000
1991	Wood Outswing French Door	Solid brass hinges introduced.	Present
1992	Wood Outswing French Doors	Simulated divided lite option introduced.	Present
1993	Clad Outswing French Doors	Factory applied brick mould casing and simulated divided lite option introduced.	Present
1994	Outswing French Doors	Beige Lexan sill changed to beige composite sill.	Present
1994	Wood Outswing French Door	Exterior factory finish available utilizing an interior glazed panel for 1 lite and ADL insulating glass.	1996
2000	Wood and Clad Outswing French Door, Transoms, sidelites Wood and Clad Ultimate Outswing French Door.	1/17/2000 New door line based on Inswing Door. Frame and sash components common when possible. Door rated to DP 20, DP 30 or DP 40 based on options and sizes selected. Transom sash in line with door sash below. Center mortise lock (center passage latch with independent dead bolt) replaces lever set with dead bolt utilizing Multi-point inswing FD handles. Multi-point (Amerock) lock available (std. Ultimate). Adjustable hinges standard. HP Package available on Clad Ultimate Outswing French Door. 8/4/2000 PVD brass hardware available on Ultimate Outswing French Door. Limited factory mulling options. Non-handed handle sets.	Present
2000	Wood and Clad Light Commercial Prep Door Introduced	1/17/2000 Unit uses common parts with outswing door. Jambs square cut at bottom to accept commercial or ADA sills. Ball bearing 4" butt hinges standard. 11 3/8" bottom rail standard. 8/4/2000 Brushed chrome ball bearing hinges available.	Present
2002	Wood and Clad Light Commercial Prep Door Introduced	3/02 Stone White becomes a standard color. Arctic White transitions to a select color. 8/0 height decreases by 2 1/2 inches.	Present
2003	Wood and Clad Outswing French Door	3/31/03 Satin Taupe (TP) hardware replaces brass as standard. Standard door now includes hardware (no lock, no bore is an option)	Present
2003	Wood and Clad Ultimate Outswing French Door	3/31/03 Satin Taupe (TP) hardware replaces brass as standard.	Present
2003	Wood and Clad Outswing Ultimate Outswing French Door	3/31/03 Strikes for Satin Taupe, Brushed Chrome, Polished Chrome and White are Stainless Steel.	Present
2004	Wood and Clad Outswing Ultimate Outswing French Door	1/04 Added Oiled Rubbed Bronze and Satin Chrome to available hardware finishes.	Present
2004	Wood and Clad Outswing French Door	4/12/04 Satin Nickel hardware finish introduced.	Present

HISTORY

PRODUCED	UNIT TYPE	FEATURES OR CHANGES	STATUS
2004	Wood and Clad Outswing French Door	6/14/04 Wood and Clad Direct Glaze transom redesigned. Polished chrome finish hardware is retired.	Present
2005	Wood and Clad Ultimate Outswing French Door	1/2005 New options: No lock. bore, bored mortise latch with deadbolt. Locking stiles use LVL core, optional bronze Ultrex sill with black weather strip. Options for Outswing French Door become available on Ultimate Outswing French Door. Outswing French Door now retired.	Present
2005	Wood/Clad Ultimate Outswing French Door	6/15/05 Changed jamb leaf on adjustable hinge to closed knuckle design.	Present
2005	Wood/Clad Ultimate Outswing French Door	6/27/05 Introduced Brass PVD and Satin Nickel PVD finishes to French door handles, adjustable hinges, and other miscellaneous parts.	Present
2006	Wood and Clad Outswing Ultimate Outswing French Door	7/24/06 Discontinued retro 6-5 height and replaced with 6-6 height. Frame OSM for 6-6 height is 3/4" taller than 6-5 doors. Frame OSM for 6-6 width is 11/16" wider (one panel), 1 3/8" wider (two panel) and 2 1/16" wider (three panel).	Present
2007	Wood and Clad Ultimate Outswing French Door	2/20/07 Introduced raised and flat panels as a standard option for Marvin French Doors and Commercial Doors.	Present
2008	Clad Ultimate Outswing French Door	7/28/2008 Mixed grain Douglas fir is now a standard option.	Present
2009	All	3/23/2009 Added LoE ³ -366™ as a standard option for all products. Added Cedro Macho as a standard option for all clad products.	Present
2010	All Doors	2/22/2010 Added Dark Bronze hardware finish for doors.	Present
2011	All Doors	4/25/2011 Added LoE-180™ as a standard option for all products. White painted interior finish option introduced for all products.	Present
2012	Wood and Clad Ultimate Outswing French Door	7/30/2012 Stave Core added to our description for current finger joint/edge glue construction of door panels. Redesign incorporating new cladding, frame and sill profile (F2050). Optional exterior sill cover available in Mahogany; Optional interior sill liner available in Oak, Mahogany, or Cherry. 10/29/2012 Interior Square Sticking/Glazing Bead option introduced. 12/17/2012 Introduced Clear Interior Finish option on all products.	Present
2013	Wood and Clad Ultimate Outswing French Door	4/29/2013 – Introduced Retro 2 Wide CNs on Full Size Heights. New CNs are 50R68, 50R70, 50R80, 60R68, 60R70, and 60R80. All Retro sizes, current and new, will be designated with an "R" in the CN. Introduced interior stain options. Stain colors are Wheat, Honey, Leather, Hazelnut, Cabernet and Espresso. 6/24/2013 – Direct Glaze Standardization added upgrades and improvements to direct glaze products in both wood and clad. Glazing method is silicone and interior tape glazed. Wood bead profile is W11751. 12/16/2013 – Interior Shades option introduced. Added SN PVD Butt Hinge option.	Present
2014	Wood and Clad Ultimate Outswing French Door	1/06/2014 – A new corner key design and weep process was implemented. See Product Bulletin 545 for more details. 2/24/2014 – Introduced two Pearlescent clad colors – Bright Silver and Copper. Discontinued two clad colors – Sherwood Green and Cobalt Blue. 4/28/2014 – Added the Contemporary Panel and Contemporary Handle options.	Present
2014	Wood and Clad Ultimate Outswing French Door	6/23/2014 – Added PVD color options for the Contemporary Handle; Oil Rubbed Bronze PVD and Satin Nickel PVD are now available.	Present
2014	Wood and Clad Ultimate Outswing French Door	10/27/2014 – Introduced Ogee as the new default interior profiles.	Present
2016	All	06/27/2016 – Introduced Matte Black as a standard hardware color. 10/31/2016 – Introduced 9-0 CN as a standard height. 10/31/2016 – Obsolescence of the wood species Cedro Macho for all products.	Present

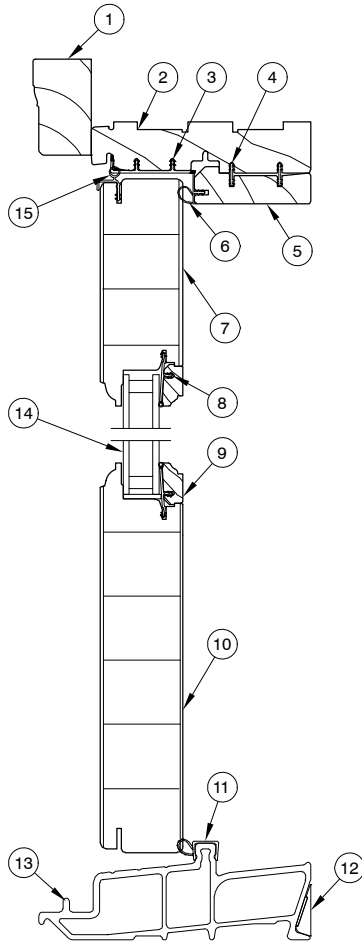
WOOD AND CLAD ULTIMATE OUTSWING FRENCH DOOR
HISTORY



Built around you.®

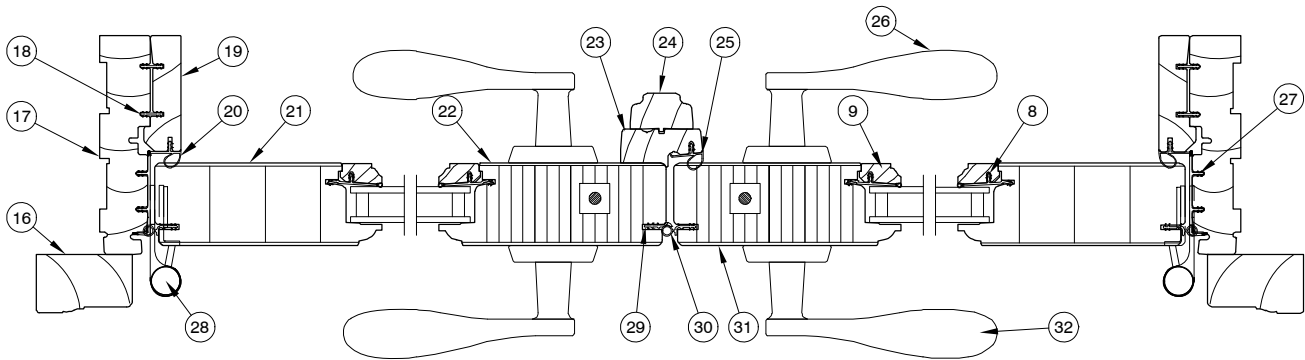
PRODUCED	UNIT TYPE	FEATURES OR CHANGES	STATUS
2017	All	10/30/2017 Discontinued Ep colors with exception of Stone White and Bronze	Present
2017	All	10/30/2017 – Discontinued Jamb align receiver and jamb align bracket.	Present
2017	Clad Ultimate Outswing French Door	12/18/2017 – Added availability of the Lock Status Sensor.	Present

**WOOD ULTIMATE OUTSWING FRENCH DOOR
 XX R or L**



1. Head Jamb Brick Mould Casing
2. Head Jamb
3. Head Jamb Frame Vinyl (V2114)
4. Head Jamb Stop Connecting Barb
5. Head Jamb Part Stop
6. Head Jamb Part Stop Weather Strip
7. Top Rail
8. Glazing Bead
9. Glazing Cap
10. Bottom Rail
11. Sill Weather Strip
12. Sill Interior Filler Block
13. Sill, 4 9/16"
14. Insulating Glass
15. Panel Cover Weather Strip
16. Jamb Brick Mould Casing
17. Jamb
18. Jamb Connecting Barb
19. Jamb Part Stop
20. Jamb Part Stop Weather Strip
21. Stile
22. Inactive Panel Locking Stile
23. Astragal Base
24. Astragal Cover
25. Astragal Weather Strip
26. Interior Handle Assembly
27. Jamb Frame Vinyl (V2114)
28. Adjustable Hinge
29. Inactive Stile Weather Strip
30. Stile Weather Strip
31. Active Panel Locking Stile
32. Exterior Handle Assembly

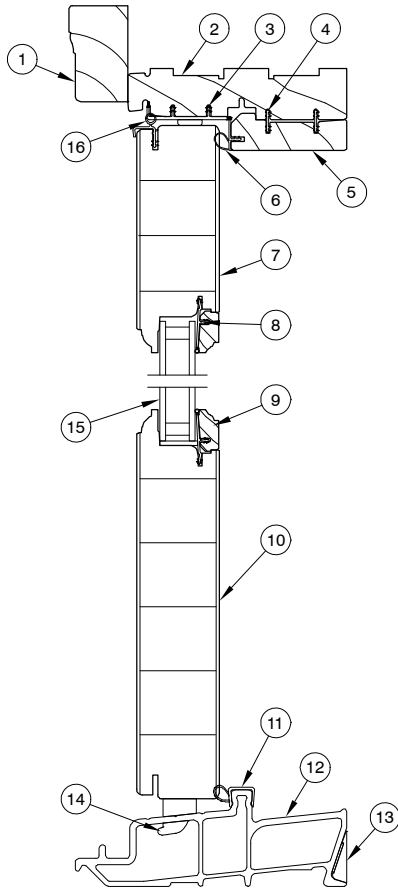
**Head Jamb
 and Sill**



Jamb - XX L

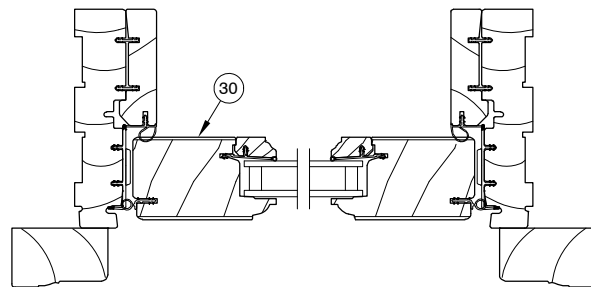
NOTE: Not to scale; specifications subject to change without notice.

**WOOD ULTIMATE OUTSWING FRENCH DOOR
 STATIONARY AND SIDELITE**

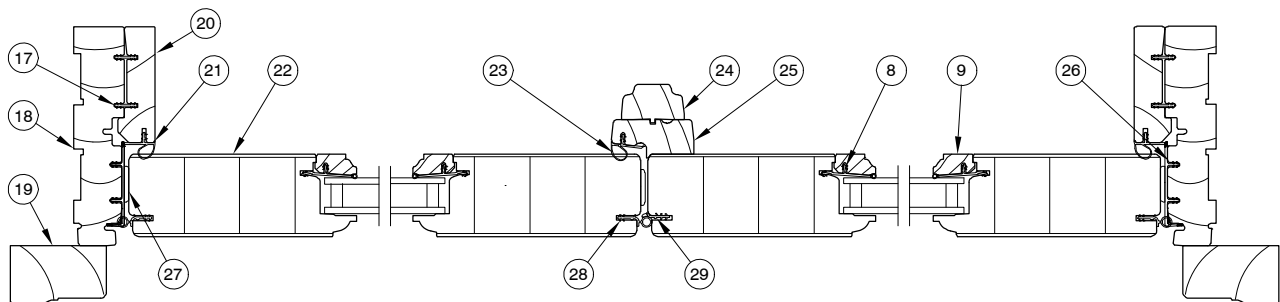


**Head Jamb
 and Sill**

1. Head Jamb Brick Mould Casing
2. Head Jamb
3. Head Jamb Frame Vinyl
4. Head Jamb Part Stop Connecting Barb
5. Head Jamb Part Stop
6. Head Jamb Part Stop Weather Strip
7. Top Rail
8. Glazing Bead
9. Glazing Cap
10. Bottom Rail
11. Sill Weather Strip
12. Sill, 4 9/16"
13. Sill Interior Filler Block
14. Stationary Panel Sill Bolt
15. Insulating Glass
16. Panel Cover Weather Strip
17. Jamb Connecting Barb
18. Jamb
19. Jamb Brick Mould Casing
20. Jamb Part Stop
21. Jamb Part Stop Weather Strip
22. Stile
23. Astragal Weather Strip
24. Astragal Cover
25. Astragal Base
26. Jamb Frame Vinyl (V2114)
27. Spacer Tack
28. Stile Weather Strip
29. Inactive Stile Weather Strip
30. Narrow Sidelite Stile



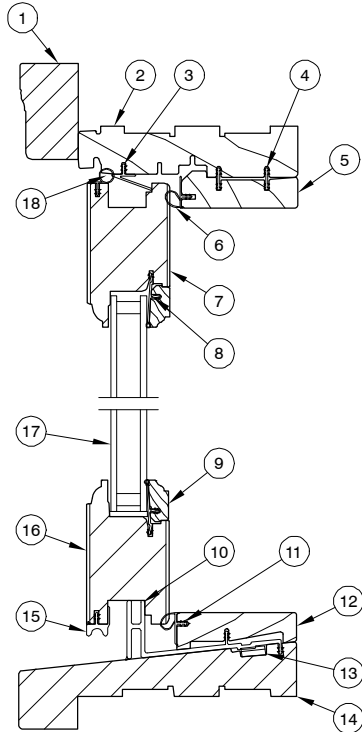
Jamb - Sidelite



Jamb - OO

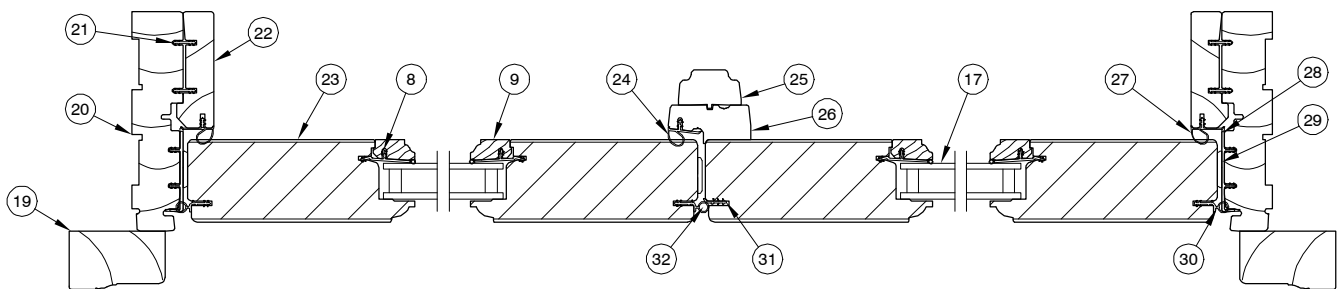
NOTE: Not to scale; specifications subject to change without notice.

**WOOD ULTIMATE OUTSWING FRENCH DOOR
 IN-SASH TRANSOM**



**Head Jamb
 and Sill**

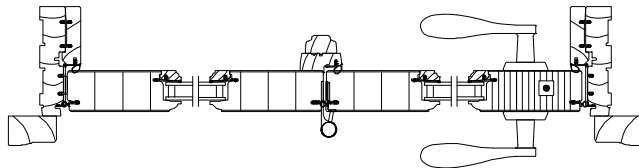
1. Head Jamb Brick Mould Casing
2. Head Jamb
3. Sash Retainer
4. Head Jamb Part Stop Connecting Barb
5. Head Jamb Part Stop
6. Head Jamb Part Stop Weather Strip
7. Top Rail
8. Glazing Bead
9. Glazing Cap
10. Sill Leveling Block
11. Sill Weather Strip
12. Sill Cover
13. Foam Tape
14. Sill
15. Panel Drip
16. Bottom Rail
17. Insulating Glass
18. Panel Weather Strip
19. Jamb Brick Mould Casing
20. Jamb
21. Jamb Connecting Barb
22. Jamb Part Stop
23. Stile
24. Astragal Weather Strip
25. Astragal Cover
26. Astragal Base
27. Jamb Part Stop Weather Strip (V2114)
28. Frame Weather Strip
29. Spacer Tack
30. Stile Weather Strip
31. Inactive Stile Weather Strip
32. Stile Weather Strip



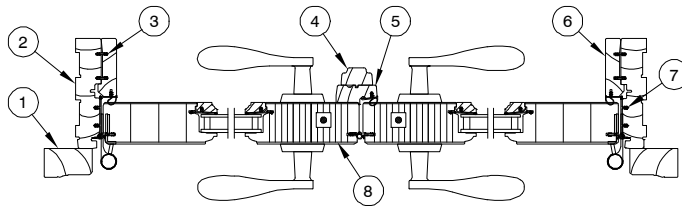
**Jamb - Transom OO
 (1 frame - 2 sash)**

NOTE: Not to scale; specifications subject to change without notice.

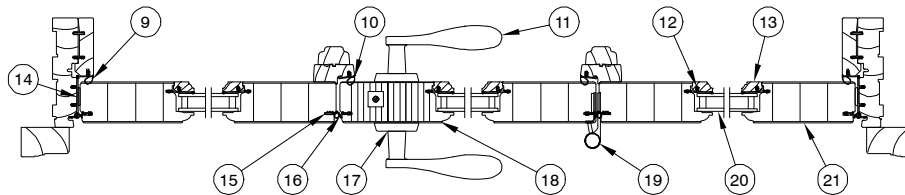
**WOOD ULTIMATE OUTSWING FRENCH DOOR
 JAMB DETAIL**



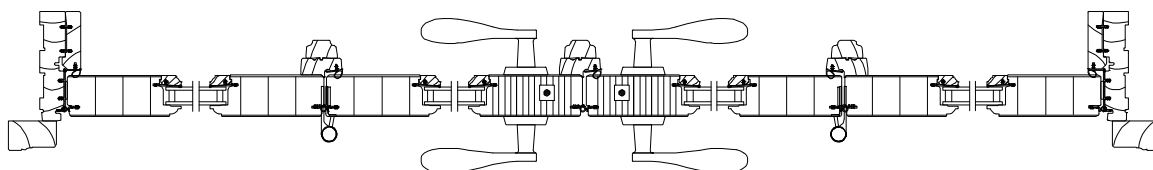
2 Panel Jamb – OX R



2 Panel Jamb – XX L



3 Panel Operating Jamb – OXO L

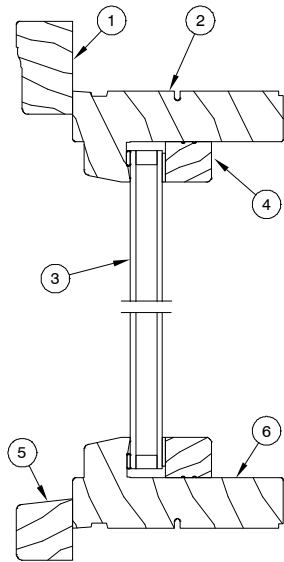


4 Panel Operating Jamb – OXXO L

1. Jamb Brick Mould Casing
2. Jamb
3. Jamb Part Stop Connecting Barb
4. Astragal Cover
5. Astragal Base
6. Jamb Part Stop
7. Jamb Frame Vinyl (V2114)
8. Inactive Panel Locking Stile
9. Jamb Part Stop Weather Strip
10. Astragal Weather Strip
11. Interior Handle Assembly
12. Glazing Bead
13. Glazing Cap
14. Spacer Tack
15. Inactive Stile Weather Strip
16. Stile Weather Strip
17. Exterior Handle Assembly
18. Active Panel Locking Stile
19. Adjustable Hinge
20. Insulating Glass
21. Stile

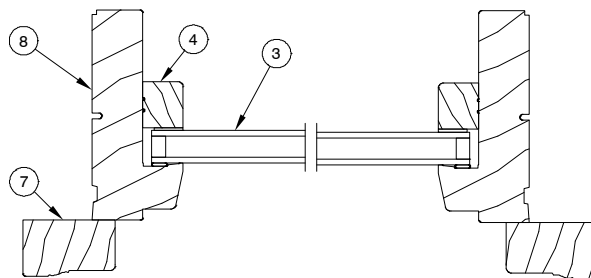
NOTE: Not to scale; specifications subject to change without notice.

**WOOD ULTIMATE OUTSWING
FRENCH DOOR DIRECT GLAZE TRANSOM**



- 1. Head Jamb Brick Mould Casing
- 2. Head Jamb
- 3. Insulating Glass
- 4. Glazing Bead (W11751)
- 5. Sill Nose, (W12059)
- 6. Sill
- 7. Jamb Brick Mould Casing
- 8. Side Jamb

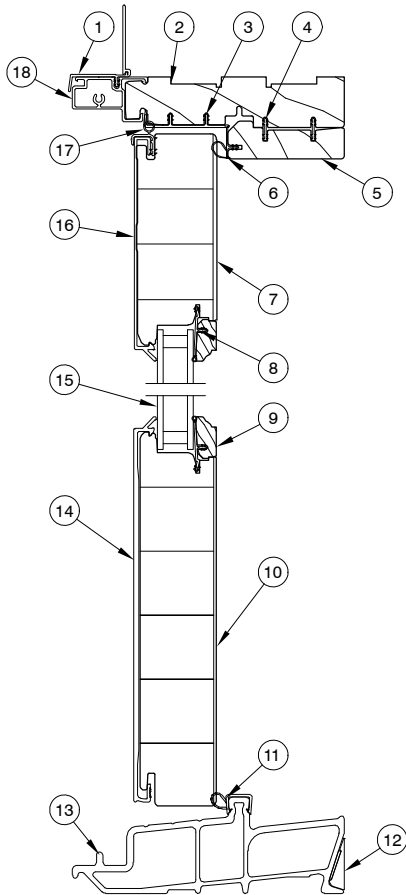
**Head Jamb
and Sill**



Jamb

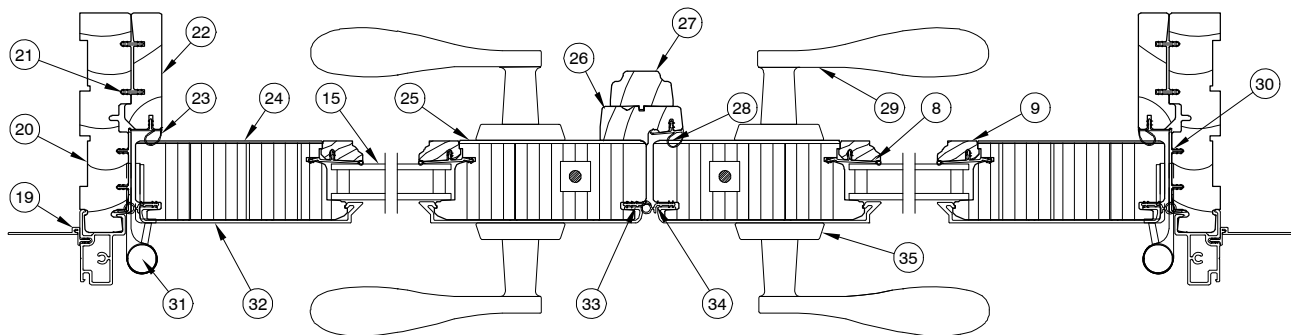
NOTE: Not to scale; specifications subject to change without notice.

**CLAD ULTIMATE OUTSWING FRENCH DOOR
 XX L or R**



1. Head Jamb Nail Fin/Drip Cap
2. Head Jamb
3. Head Jamb Vinyl (V2114)
4. Head Jamb Part Stop Connecting Barb
5. Head Jamb Part Stop
6. Head Jamb Part Stop Weather Strip
7. Top Rail
8. Glazing Bead
9. Glazing Cap
10. Bottom Rail
11. Sill Weather Strip
12. Sill Liner
13. Sill, 4 9/16"
14. Bottom Rail Cladding
15. Insulating Glass
16. Top Rail Cladding
17. Panel Cover Weather Strip
18. Head Jamb Cladding
19. Jamb Nailing Fin
20. Jamb
21. Jamb Part Stop Connecting Barb
22. Jamb Part Stop
23. Jamb Part Stop Weather Strip
24. Stile
25. Inactive Panel Locking Stile
26. Astragal Base
27. Astragal Cover
28. Astragal Weather Strip
29. Interior Handle Assembly
30. Jamb Vinyl (V2114)
31. Adjustable Hinge
32. Stile Cladding
33. Inactive Weather Strip
34. Stile Weather Strip
35. Exterior Handle Assembly

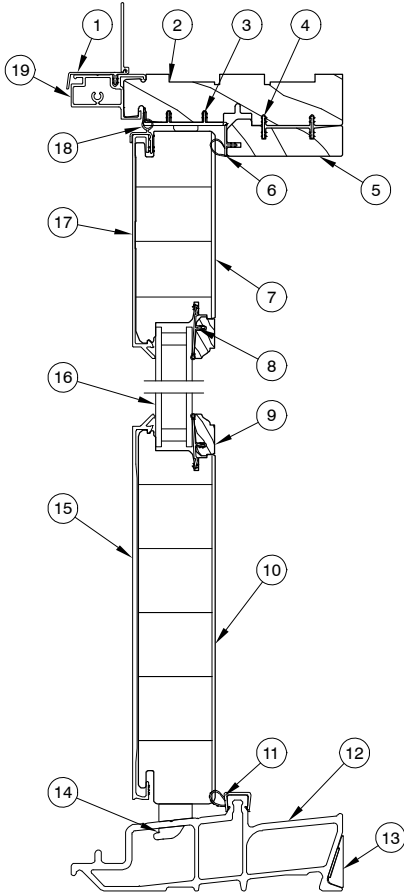
**Head Jamb
 and Sill**



Jamb - XX L

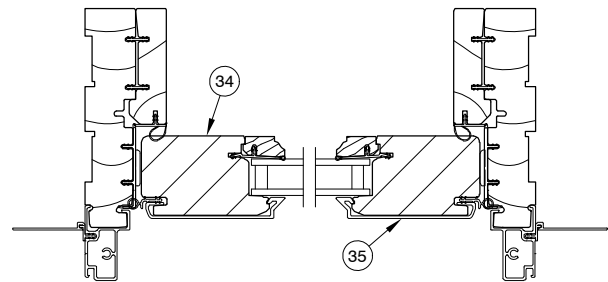
NOTE: Not to scale; specifications subject to change without notice.

**CLAD ULTIMATE OUTSWING FRENCH DOOR
 STATIONARY**

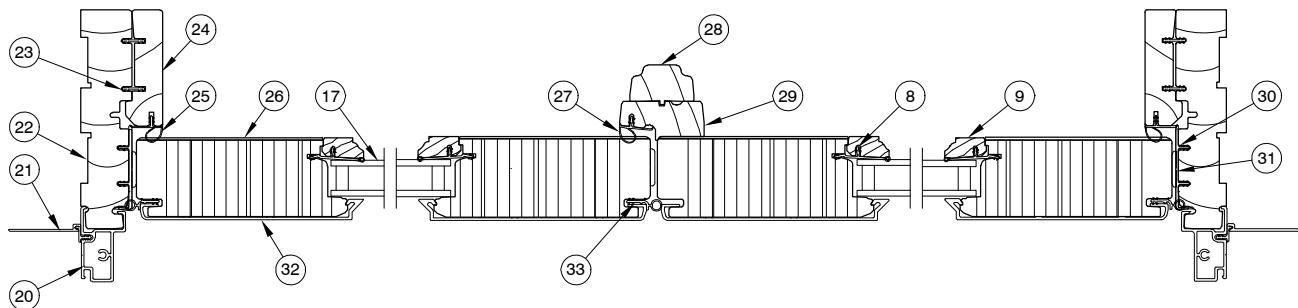


**Head Jamb
 and Sill**

1. Head Jamb Nail Fin/Drip Cap
2. Head Jamb
3. Head Jamb Vinyl (V2114)
4. Head Jamb Part Stop Connecting Barb
5. Head Jamb Part Stop
6. Head Jamb Part Stop Weather Strip
7. Top Rail
8. Glazing Bead
9. Glazing Cap
10. Bottom Rail
11. Sill Weather Strip
12. Sill, 4 9/16"
13. Sill Interior Filler
14. Stationary Sill Bolt
15. Bottom Rail Cladding
16. Insulating Glass
17. Top Rail Cladding
18. Panel Cover Weather Strip
19. Head Jamb Cladding
20. Jamb Cladding
21. Jamb Nailing Fin
22. Jamb
23. Jamb Part Stop Connecting Barb
24. Jamb Part Stop
25. Jamb Part Stop Weather Strip
26. Stile
27. Astragal Weather Strip
28. Astragal Cover
29. Astragal Base
30. Jamb Weather Strip
31. Spacer Tack
32. Stile Cladding
33. Stile Weather Strip
34. Narrow Sidelite Stile
35. Narrow Sidelite Stile Cladding



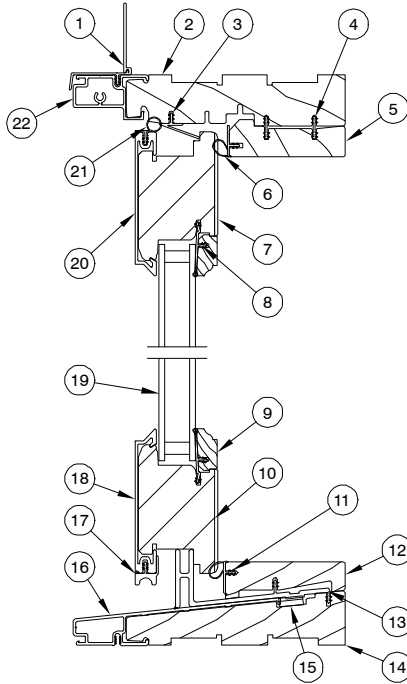
Sidelite



Jamb - OO

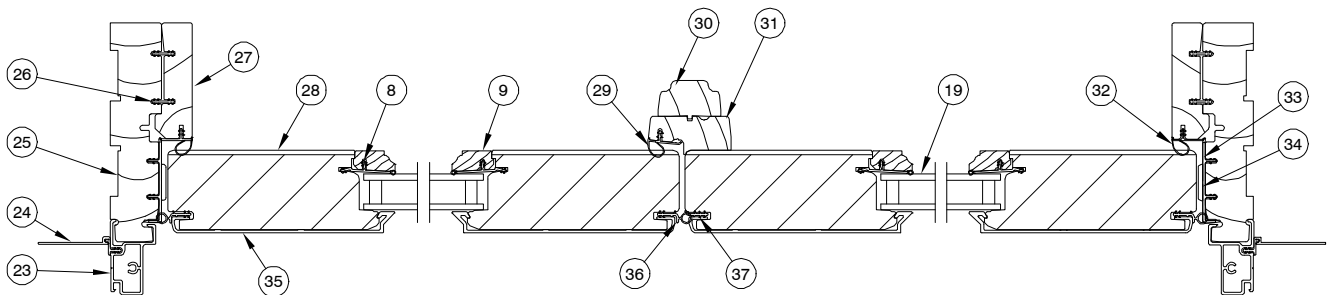
NOTE: Not to scale; specifications subject to change without notice.

**CLAD ULTIMATE OUTSWING FRENCH DOOR
 IN-SASH TRANSOM**



**Head Jamb
 and Sill**

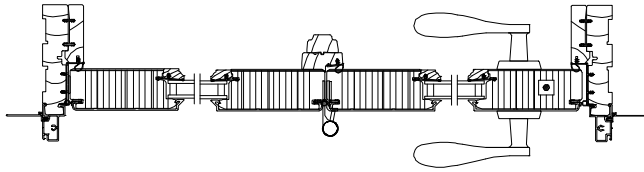
1. Head Jamb Nail Fin/Drip Cap
2. Head Jamb
3. Sash Retainer
4. Head Jamb Stop Connecting Barb
5. Head Jamb Stop
6. Head Jamb Stop Weather Strip
7. Top Rail
8. Glazing Bead
9. Glazing Cap
10. Bottom Rail
11. Sill Cover Weather Strip
12. Sill Cover
13. Sill Leveling Block
14. Sill
15. Foam Tape
16. Sill Cladding
17. Panel Drip
18. Bottom Rail Cladding
19. Insulating Glass
20. Top Rail Cladding
21. Top Rail Weather Strip
22. Head Jamb Cladding
23. Jamb Cladding
24. Jamb Nailing Fin
25. Jamb
26. Jamb Connecting Barb
27. Jamb Stop
28. Stile
29. Astragal Weather Strip
30. Astragal Cover
31. Astragal Base
32. Jamb Stop Weather Strip
33. Jamb Weather Strip
34. Spacer Tack
35. Stile Cladding
36. Stile Weather Strip
37. Inactive Stile Weather Strip



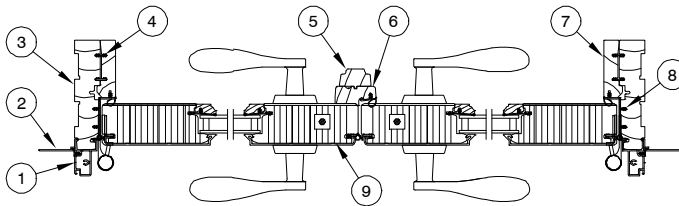
**Jamb - Transom - OO
 (1 frame - 2 sash)**

NOTE: Not to scale; specifications subject to change without notice.

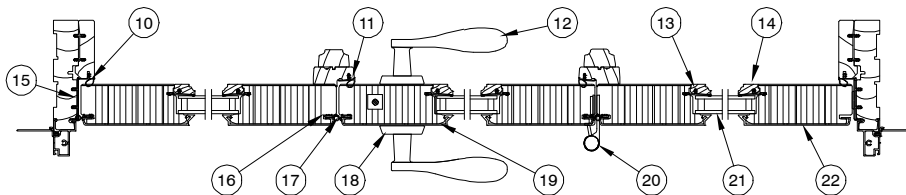
**CLAD ULTIMATE OUTSWING FRENCH DOOR
 JAMB DETAIL**



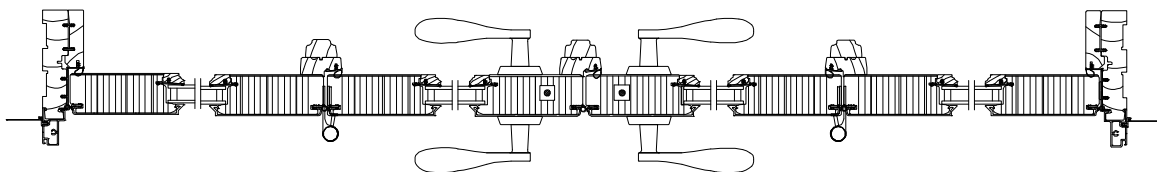
2 Panel Jamb – OX R



2 Panel Jamb – XX L



3 Panel Operating Jamb – OXO L

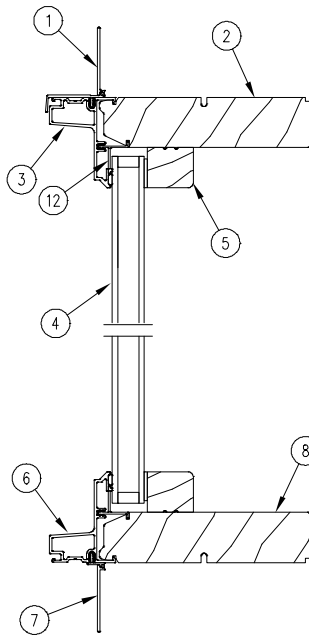


4 Panel Operating Jamb – OXXO L

1. Jamb Cladding
2. Jamb Nailing Fin
3. Jamb
4. Jamb Stop Connecting Barb
5. Astragal Cover
6. Astragal Base
7. Jamb Stop
8. Jamb Weather Strip
9. Inactive Panel Locking Stile
10. Jamb Stop Weather Strip
11. Astragal Weather Strip
12. Interior Handle Assembly
13. Glazing Bead
14. Glazing Cap
15. Spacer Tack
16. Inactive Stile Weather Strip
17. Stile Weather Strip
18. Exterior Handle Assembly
19. Active Panel Locking Stile
20. Adjustable Hinge
21. Insulating Glass
22. Stile

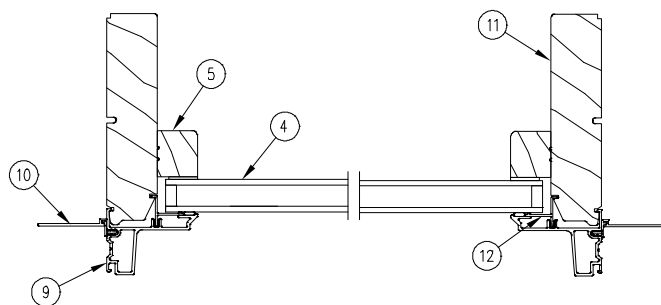
NOTE: Not to scale; specifications subject to change without notice.

**CLAD ULTIMATE OUTSWING FRENCH DOOR
DIRECT GLAZE TRANSOM**



- 1. Head Jamb Nailing Fin/Drip Cap
- 2. Head Jamb
- 3. Head Jamb Cladding
- 4. Insulated Glass
- 5. Glazing Bead (W11751)
- 6. Sill Cladding
- 7. Sill Nailing Fin
- 8. Sill
- 9. Jamb Cladding
- 10. Jamb Nailing Fin
- 11. Jamb
- 12. Attachment Barb

**Head Jamb
and Sill**



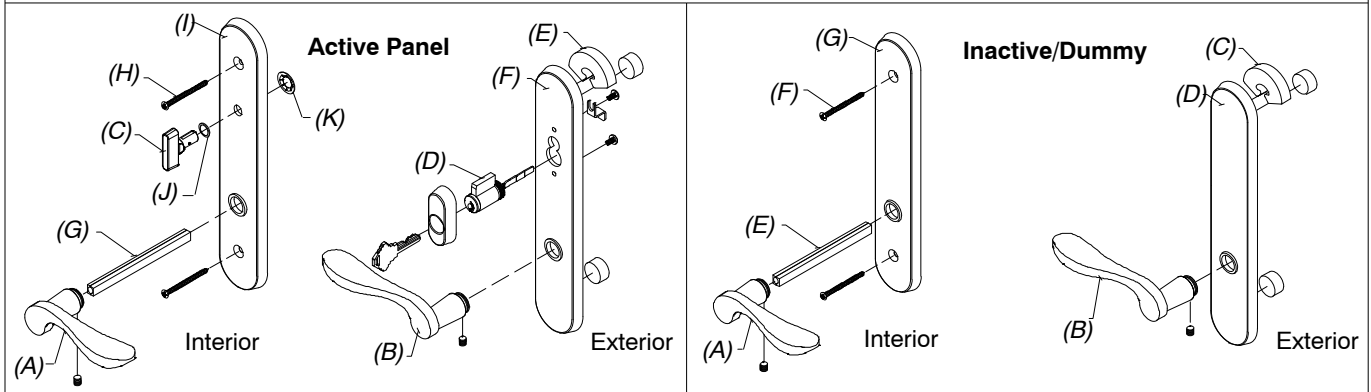
Jamb Detail

NOTE: Not to scale; specifications subject to change without notice.


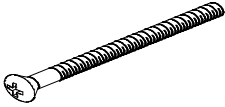
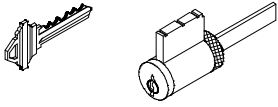
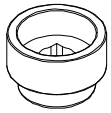
When ordering replacement parts specify:

1. type of unit;
2. part number;
3. description.

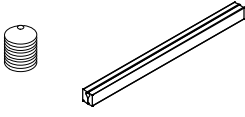
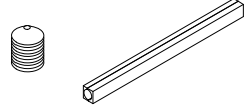


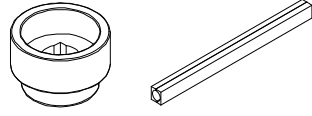
ILLUSTRATIONS (not to scale)



<p>Handle Assembly, Active Panel Mortise lock and Multi-point lock systems (Schlage "C" keyway) <i>Includes:</i> 1 - Interior lever (A) with spindle, escutcheon plate and hardware 1 - Exterior lever (B) with escutcheon plate and hardware 1 - Thumb turn (C) with hardware 1 - Keyed cylinder (D) with housing and hardware 1 - Exterior escutcheon plate gasket (E) 1 - Exterior escutcheon plate (F) 1 - Two piece spindle (G) 2 - #10-32 x 2 1/8" Phillips ovalhead machine screws (H) 1 - Interior escutcheon plate (I) 1 - Thumb turn washer (J) 1 - Thumb turn push nut (K) 2 - Keys</p>	<p>Satin Taupe Antique Brass White Satin Chrome Oil Rubbed Bronze ORBZ PVD Brass PVD Satin Nickel PVD Dark Bronze Matte Black Polished Chrome</p>	<p>10830304 10830306 10830310 10830302 10148111 10830300 10830324 10830421 10830330 10830450 10830308</p>
<p>Handle Assembly, Inactive/Dummy <i>Includes:</i> 1 - Interior lever (A) with spindle, escutcheon plate and hardware 1 - Exterior lever (B) with escutcheon plate and hardware 1 - Exterior escutcheon plate gasket (C) 1 - Exterior escutcheon plate (D) 1 - Two piece spindle (E) 2 - #10-32 x 2 1/8" Phillips ovalhead machine screws (F) 1 - Interior escutcheon plate (G)</p>	<p>Satin Taupe Antique Brass White Satin Chrome Oil Rubbed Bronze ORBZ PVD Brass PVD Satin Nickel PVD Dark Bronze Matte Black Polished Chrome</p>	<p>10830318 10830312 10830316 10830320 10148154 10830322 10830326 10830422 10830328 10148157 10830314</p>
<p>Thumb Turn (C) NOTE: For each thumb turn, order one thumb turn washer -00143045 (J) and one thumb turn push nut 00143010 (K).</p>	<p>Satin Taupe Antique Brass White Satin Chrome Oil Rubbed Bronze Oil Rubbed Bronze PVD Brass PVD Satin Nickel PVD Dark Bronze Matte Black</p>	<p>00142061 00142055 00142058 00142064 00142062 10148428 00142054 00142063 10148426 10148480</p>

ILLUSTRATION NOT TO SCALE	DESCRIPTION	OPER./COLOR	PART NO.
	Lug seals		00142046
	#10-32 x 2 1/8" Phillips ovalhead machine screws	Satin Taupe Antique Brass White Satin Chrome Oil Rubbed Bronze Oil Rubbed Bronze PVD Brass PVD Satin Nickel PVD Dark Bronze Matte Black	11800616 00143038 00143036 10840031 10840032 11800160 11800615 NA 11800654 11800181
	Key Cylinder, Lock (Schlage "C" keyway) For service replacement only. <i>NOTE: For Keyed Alike orders, use program C87P2.</i> <i>BS, ORBZ PVD, TP, WH, AB=Brass Face</i> <i>All other Marvin finishes=Chrome Face</i>	Brass Face Chrome Face	10830211 10830208
	3/4" Handle Extension Requires 3/4" Spindle Extension	Satin Taupe Antique Brass White Satin Chrome Oil Rubbed Bronze Oil Rubbed Bronze PVD Brass PVD Satin Nickel PVD Dark Bronze Matte Black Polished Chrome	10833060 10833057 10833063 10833056 10833038 10833059 10833058 10148422 10833054 10833055 10833062
	3/8" Handle Extension Requires 3/8" Spindle Extension	Satin Taupe Antique Brass White Satin Chrome Oil Rubbed Bronze Oil Rubbed Bronze PVD Brass PVD Satin Nickel PVD Dark Bronze Matte Black Polished Chrome	10833049 10833046 10833052 10833045 10833044 10833048 10833047 10833050 10833042 10833043 10833051

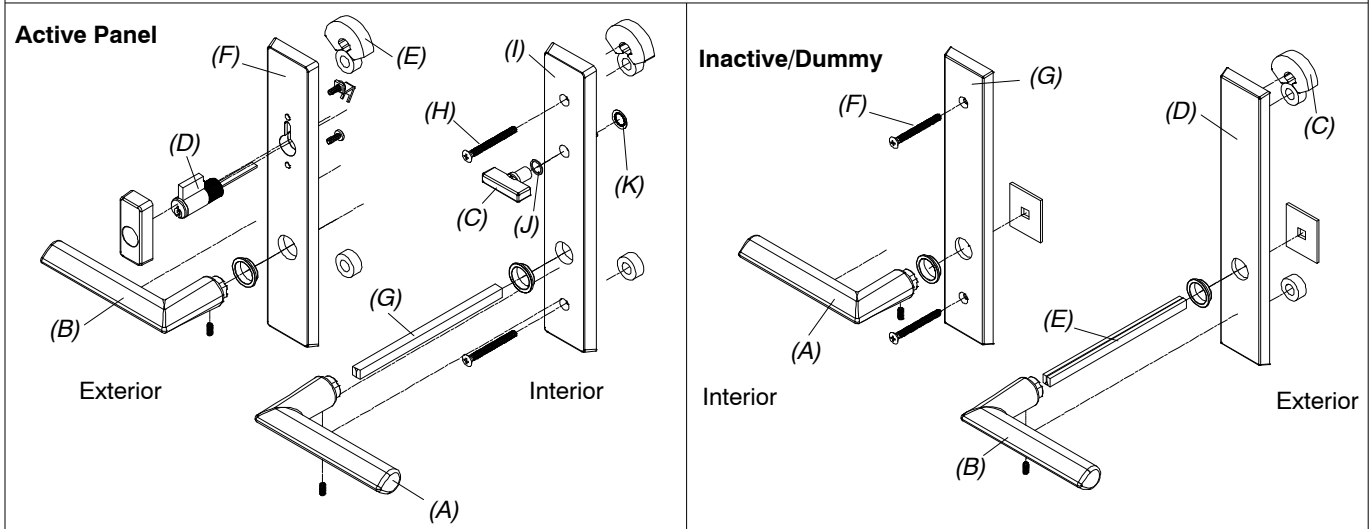
NOTE: Dark Bronze screws are used with Antique Brass and Oil Rubbed Bronze PVD

ILLUSTRATION NOT TO SCALE	DESCRIPTION	LENGTH./COLOR	PART NO.
	<p>Spindle Kit (Truth & Ashland) Includes: 1 – 2 piece. spindle, 4 3/8” 2 – Set screws</p>	<p>Used with: Satin Taupe, White, Dark Bronze, Matte Black, Satin Chrome, Antique Brass, Oil Rubbed Bronze, Oil Rubbed Bronze PVD</p>	<p>02100942</p>
	<p>Spindle Kit (HOPPE) Includes: 1 – 2 piece. spindle, 4 3/4” 2 – Set screws</p>	<p>Used with Satin Nickel PVD Brass PVD</p>	<p>10148414</p>
	<p>Lever Bushing, Swinging Handle Set – Traditional</p>	<p>Clear Gray Gold Natural Black</p>	<p>02062201 10148448 10148447 02062202 10148020</p>
	<p>3/4” Spindle Extension 3/8” Spindle Extension</p>	<p>5 13/16” 5 1/16”</p>	<p>00142051 18900393</p>
	<p>1 3/4” Swinging Handle Set Kit – Interior Shades Includes: 1 – 3/4” extension handle 1 – Spindle, lever handle, 2 pc. assembly 1 – Installation instruction</p>	<p>Satin Taupe Antique Brass White Satin Chrome Oil Rubbed Bronze Oil Rubbed Bronze PVD Brass PVD Satin Nickel PVD Dark Bronze Matte Black Polished Chrome</p>	<p>18900650 18900653 18900651 18900656 18900654 18900655 18900652 18900657 18900658 18900688 18900669</p>

When ordering replacement parts specify:

1. type of unit;
2. part number;
3. description.

ILLUSTRATIONS (not to scale)



<p>Handle Assembly, Active Panel Mortise lock and Multi-point lock systems (Schlage "C" keyway) Includes: 1 – Interior lever (A) with 10148414 spindle, escutcheon plate and hardware 1 – Exterior lever (B) with escutcheon plate and hardware 1 – Thumb turn (C) with hardware 1 – Keyed cylinder (D) with housing and hardware 1 – Exterior escutcheon plate gasket (E) 1 – Exterior escutcheon plate (F) 1 – Two piece spindle (G) 2 – M5 x 55mm Phillips ovalhead machine screws (H) 1 – Interior escutcheon plate (I) 1 – Thumb turn washer (J) 1 – Thumb turn push nut (K) 2 – Keys</p>	<p>Oil Rubbed Bronze PVD Satin Nickel PVD Dark Bronze Matte Black</p>	<p>11102151 11102152 11102156 11102192</p>
<p>Handle Assembly, Inactive/Dummy Includes: 1 – Interior lever (A) with spindle, escutcheon plate and hardware 1 – Exterior lever (B) with escutcheon plate and hardware 1 – Exterior escutcheon plate gasket (C) 1 – Exterior escutcheon plate (D) 1 – Two piece spindle (E) 2 – M5 x 55mm Phillips ovalhead machine screws (F) 1 – Interior escutcheon plate (G)</p>	<p>Oil Rubbed Bronze PVD Satin Nickel PVD Dark Bronze Matte Black</p>	<p>11102154 11102155 11102157 11102193</p>
<p>Thumb Turn (C) NOTE: For each thumb turn, order one thumb turn washer –10148423(J) and one thumb turn push nut 10148424(K).</p>	<p>Oil Rubbed Bronze PVD Satin Nickel PVD Dark Bronze</p>	<p>10148428 10148427 10148426</p>


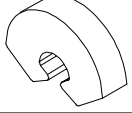

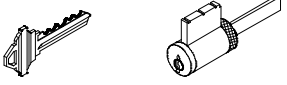
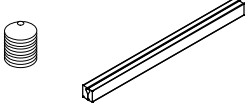
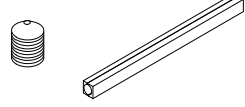

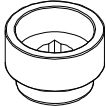

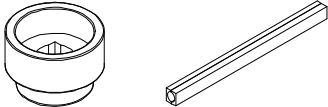

ILLUSTRATION NOT TO SCALE	DESCRIPTION	OPER./COLOR	PART NO.
	Gasket Post		10148404
	Gasket – Top Backplate		10148405
	M5 x 55mm Phillips ovalhead machine screw	Satin Taupe Oil Rubbed Bronze PVD Satin Nickel PVD Dark Bronze Matte Black	10148400 10148402 10148403 10148401 10148440
	Key Cylinder, Lock (Schlage “C” keyway) For service replacement only. <i>NOTE: For Keyed Alike orders, use program C87P2.</i> <i>BS, ORBZ PVD, TP, WH, AB=Brass Face</i> <i>All other Marvin finishes=Chrome Face</i>	Brass Face Chrome Face	10830211 10830208
	Spindle Kit (Truth & Ashland) <i>Includes:</i> 1 – 2 piece. spindle, 4 3/8” 2 – Set screws	Used with: Satin Taupe, White, Dark Bronze, Matte Black, Satin Chrome, Antique Brass, Oil Rubbed Bronze, Oil Rubbed Bronze PVD	02100942
	Spindle Kit (HOPPE) <i>Includes:</i> 1 – 2 piece. spindle, 4 3/4” 2 – Set screws	Used with Satin Nickel PVD Brass PVD	10148414
	Lever Bushing, Swinging Handle Set – Contemporary	Gray Natural Black	10148448 02062202 10148020
	3/4" Handle Extension Requires 3/4" Spindle Extension	Satin Taupe Oil Rubbed Bronze PVD Satin Nickel PVD Dark Bronze	10148419 10148421 10148422 10148420
	3/4" Spindle Extension (HOPPE)		10148415
	1 3/4" Swinging Handle Set Kit – Interior Shades <i>Includes:</i> 1 – 3/4" extension handle 1 – Spindle, lever handle, 2 pc. assembly 1 – Installation instruction	Satin Taupe Oil Rubbed Bronze PVD Satin Nickel PVD Dark Bronze	21448100 21448102 21448103 21448101
	Spring Cartridge, Swinging Handle Set – Contemporary		10830452

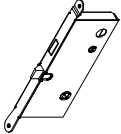

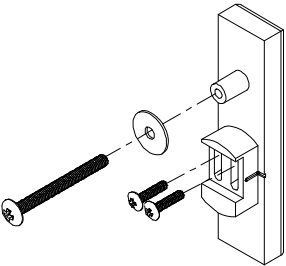
ILLUSTRATION NOT TO SCALE	DESCRIPTION	OPER./COLOR	PART NO.
	<p>Strike Plate, Jamb – Mortise Lock or Multi-Point Lock* 1/17/00 – Present (Amerock) Includes: 1 – Jamb strike plate 2 – #8x1" Brass Phillips flathead wood screws</p>	<p>Stainless Steel Antique Brass Oil Rubbed Bronze PVD Brass PVD</p>	<p>05700016 05700012 05700118 10148175</p>
	<p>Strike Plate, Panel – Mortise Lock or Multi-Point Lock* 1/17/00 – Present (Amerock) Includes: 1 – Jamb strike plate 2 – #8x1" Brass Phillips flathead wood screws</p>	<p>Stainless Steel Antique Brass Oil Rubbed Bronze PVD Brass PVD</p>	<p>05700049 05700044 05700117 10148176</p>
	<p>Cover Plate, Active Panel – Mortise Lock or Multi-Point Lock* 1/17/00 – Present (Amerock) Includes: 1 – Cover plate 2 – #8x1" Phillips flathead wood screws</p>	<p>Stainless Steel Antique Brass Oil Rubbed Bronze PVD Brass PVD</p>	<p>05700306 05700307 05700308 10148179</p>
	<p>Mortise Lock, Active Single-Point Lock (latch, dead bolt only) 1/17/00 – Present (Amerock)</p>		<p>05700129</p>
	<p>Mortise Lock, Active Multi-Point Lock (latch, dead bolt and head/foot shoot bolts) 1/17/00 – Present (Amerock)</p>		<p>05700130</p>
	<p>Mortise Lock, Inactive Multi-Point Lock (head/foot shoot bolts) 1/17/00 – Present (Amerock)</p>		<p>05700131</p>
	<p>Long Hinge Screw Package OFD – std. UOFD – std. Includes: 4 – #10 X 2 1/2" Screws 1 – 5/32" Allen wrench NOTE: Order DK BZ screw package for DK BZ, AB and ORBZ Hinges. Order SS screw package for SF, SC and SN PVD Hinges .</p>	<p>Satin Taupe Goldtone Dark Bronze White Stainless Steel Brass PVD Matte Black</p>	<p>11800653 11800632 11800644 11800637 11800639 10148185 11800696</p>
	<p>Construction Lock Assembly For Marvin residential swinging and sliding doors with standard locks. Includes: 1 – Construction Lock Cover 1 – Construction Lock Hole Cover 1 – Washer 2 – #6-32 X 5/8" Phillips TH screws 1 – #10-32 X 2" Phillips TH screw</p>	<p>Each 25/Box</p>	<p>18450200 18450198</p>

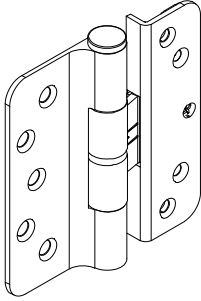
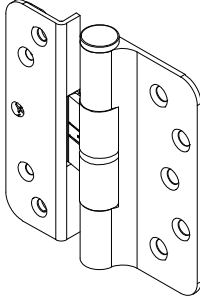
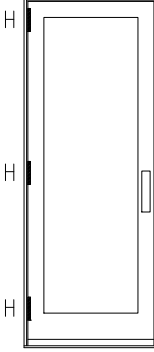
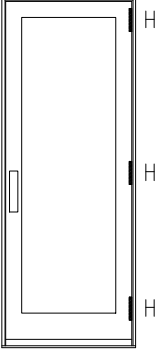
ILLUSTRATION NOT TO SCALE				
<p style="text-align: right;">Note: Always view units from the exterior for handing. H = Hinge location.</p> <div style="display: flex; justify-content: space-around; align-items: flex-start;"> <div style="text-align: center;">  <p>LH Hinge</p> </div> <div style="text-align: center;">  <p>RH Hinge</p> </div> <div style="text-align: center;"> <p><i>This panel uses the right hand hinge</i></p>  <p>X-R</p> </div> <div style="text-align: center;">  <p>X-L</p> <p><i>This panel uses the left hand hinge</i></p> </div> </div>				
ILLUSTRATION NOT TO SCALE	DESCRIPTION	HINGE COLOR	LEFT PART NO.	RIGHT PART NO.
<p>Hinge Kit, Adjustable Includes: 1 - Adjustable hinge 1 - #10x2 1/2" Phillips flathead wood screws (jamb) 5 - #10x3/4" Phillips flathead wood screws (jamb, stationary stile) 4 - #8x1 1/2" Phillips flathead wood screws (panel)</p> <p>NOTE: Hinge part number includes the color matched screws. If you need to order the screws separately, they are listed below.</p>		Satin Taupe (TP)	02101216	02101227
		Goldtone (GT)	02101213	02101224
		Silver Frost (SF)	02101218	02101229
		Dark Bronze (DKBZ)	02101217	02101228
		Antique Brass (AB)	02101210	02101221
		White (WH)	02101214	02101225
		Satin Chrome (SC)	02101212	02101223
		Oil Rubbed Bronze (ORBZ)	02101219	02101230
		Oil Rubbed Bronze (ORBZ) PVD	02101211	02101222
		Brass (BS) PVD	02101215	02101226
		Satin Nickel (SN) PVD	02101220	02101231
		Polished Chrome (PC)	02101234	02101235
	Matte Black (MBK)	02101236	02101237	
SCREW DESCRIPTION	SCREW PART NO./COLOR	MATCHING HINGE COLOR		
#8x1 1/2" Phillips flathead wood screws (panel). Quantity of four needed per hinge.	11865177 TP	TP		
	11865172 GT	GT		
	11865173 WH	WH		
	02058013 DKBZ	AB, ORBZ PVD, DKBZ, ORBZ		
	11865176 BS PVD	BS PVD,		
	11865175 Stainless Steel	SC, SF, SN PVD, PC		
	11865178 MBK	MBK		
#10x 3/4" Phillips flathead wood screws (jamb) (stationary stile). Quantity of five needed per hinge.	11800674 TP	TP		
	11800670 GT	GT		
	11800671 WH	WH		
	11800669 DKBZ	AB, ORBZ PVD, DKBZ, ORBZ		
	11800673 BS PVD	BS PVD,		
	11800672 Chrome	SC, SF, SN PVD, PC		
	11800677 MBK	MBK		
#10x2 1/2" Phillips flathead wood screws (jamb). Quantity of one needed per hinge.	11800683 TP	TP		
	11800681 GT	GT		
	11800682 WH	WH		
	11800680 DKBZ	AB, ORBZ PVD, DKBZ, ORBZ		
	11800679 BS PVD	BS PVD,		
	11800684 Stainless Steel	SC, SF, SN PVD, PC		
	11800693 MBK	MBK		

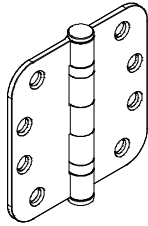
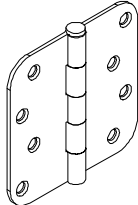
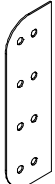

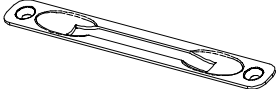
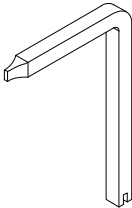
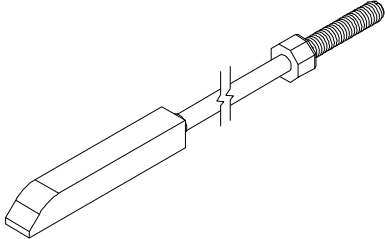
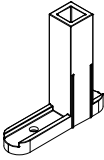
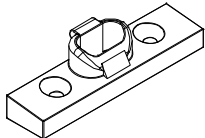
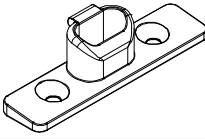
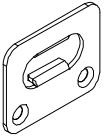
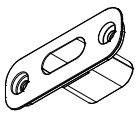
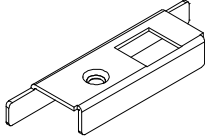

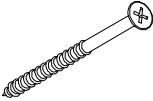
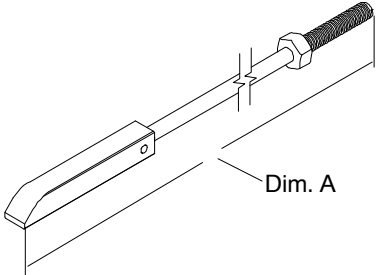
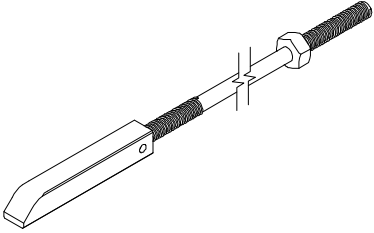
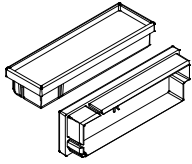
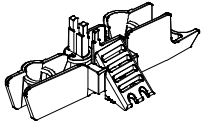
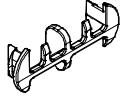
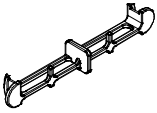


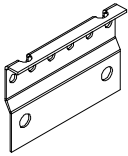
ILLUSTRATION NOT TO SCALE	DESCRIPTION	OPER./COLOR	PART NO.
	<p>Ball Bearing Hinge 4" x 4"</p>	<p>Brass Satin Chrome Bronze</p>	<p>02100470 02100471 02100472</p>
	<p>4" Butt Hinge NRP = Non Removable Pin Includes: 1 - 4" Hinge 7 - #9 x 1" Phillips flathead wood screws (11213824) 1 - #10 x 2 1/2" Phillips flathead wood screws (frame) (11800679)</p>	<p>Brass Satin Nickel PVD Stainless Steel</p>	<p>02101140 02100599 11809005</p>
	<p>4" Butt Hinge Shim</p>		<p>10500222</p>
	<p>Head or Foot Flush Bolt - Inactive Panel</p>	<p>Black</p>	<p>11101780</p>
	<p>Cover Plate for Flush Bolt Includes: 1 - Cover plate 2 - #8 x 1" Stainless Steel Screw (11800645)</p>	<p>Aluminum</p>	<p>11860402</p>
	<p>Construction Handle</p>		<p>10830451</p>

ILLUSTRATION NOT TO SCALE	DESCRIPTION	OPER./COLOR	PART NO.																
	<p>Inactive Panel Locking Rod Assembly, Top or Bottom Flush Bolt (XX configuration) 1/17/00 – Present Includes: 1 – Locking rod with end bolt</p> <p>NOTE: For 8-0 ht order top locking rod 05700185.</p> <table border="0"> <tr> <td>Height</td> <td>Top Locking Rod Length</td> </tr> <tr> <td>CN 6-6R ht*</td> <td>11"</td> </tr> <tr> <td>CN 6-8 ht</td> <td>11"</td> </tr> <tr> <td>CN 7-0 ht</td> <td>11"</td> </tr> <tr> <td>CN 8-0 ht</td> <td>27"</td> </tr> <tr> <td>CN 9-0 ht</td> <td>34 1/4"</td> </tr> </table> <table border="0"> <tr> <td>Height</td> <td>Bottom Locking Rod Length</td> </tr> <tr> <td>All heights</td> <td>11"</td> </tr> </table>	Height	Top Locking Rod Length	CN 6-6R ht*	11"	CN 6-8 ht	11"	CN 7-0 ht	11"	CN 8-0 ht	27"	CN 9-0 ht	34 1/4"	Height	Bottom Locking Rod Length	All heights	11"	<p>Stainless Steel</p> <p>Stainless Steel</p>	<p>05700180 05700180 05700180 05700185 05700170</p> <p>10815178</p>
Height	Top Locking Rod Length																		
CN 6-6R ht*	11"																		
CN 6-8 ht	11"																		
CN 7-0 ht	11"																		
CN 8-0 ht	27"																		
CN 9-0 ht	34 1/4"																		
Height	Bottom Locking Rod Length																		
All heights	11"																		
	<p>Shoot Bolt Guide Active Panels – w/Multi-Point Inactive Panels – All Includes: 1 – Shoot bolt guide (10815186) 1 – #8x1 1/2" Phillips panhead wood screw (11800766)</p>		<p>10815199</p>																
	<p>Sill Bolt, Stationary Outswing Includes:</p>	<p>Zinc Plated Black</p>	<p>11869848</p>																
	<p>Sill Bolt, Center, Stationary Includes:</p>	<p>Zinc Plated Black</p>	<p>11869821</p>																
	<p>Strike, Sill Includes:</p>	<p>Stainless Steel</p>	<p>10148080</p>																
	<p>Strike Plate, Head Jamb Includes: 2 – #8 x 5/8" Phillips trusshead stainless steel machine screws (head jamb)(11800815) 2 – #8 x 3" trusshead SS screw</p>	<p>Beige Bronze</p>	<p>05700315 05700316</p>																
	<p>Stile End Plate Includes:</p>	<p>Stainless Steel</p>	<p>10148008 (LH) 10148007 (RH)</p>																

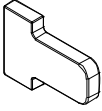
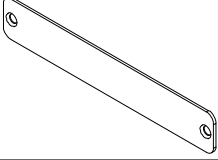
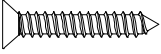
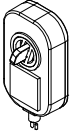

* Can be used for obsolete 6-5 height.

ILLUSTRATION NOT TO SCALE	DESCRIPTION	OPER./COLOR	PART NO.												
	Well-Nut Sill Strike	Black	10830008												
	Installation Screw Package; Strike Plate(s) at head jamb, or locking jamb #8 x 2 1/2" Flathead wood screw Package of 4 Package of 4 Package of 4	Stainless Steel Brass PVD Antique Brass	11882349 11882343 11882347												
 <p style="text-align: right;">Dim. A</p>	Locking Rod Assembly, Top – Multi-Point Lock <i>3/02- Present (Amerock) 8-0 Height see History</i> <i>5/10/90 – Present (Amerock) 6-5, 6-8, & 7-0 Height</i> Solid stainless steel rod with 1/4" – 20 threads NOTE: For special heights give dimension A. <table border="0"> <thead> <tr> <th>Height</th> <th>Top Locking Rod Length</th> </tr> </thead> <tbody> <tr> <td>CN 6-6R ht</td> <td>35 7/16"</td> </tr> <tr> <td>CN 6-8 ht</td> <td>37 15/16"</td> </tr> <tr> <td>CN 7-0 ht</td> <td>41 15/16"</td> </tr> <tr> <td>CN 8-0 ht</td> <td>51 7/16"</td> </tr> <tr> <td>CN 9-0 ht</td> <td>63 7/16"</td> </tr> </tbody> </table>	Height	Top Locking Rod Length	CN 6-6R ht	35 7/16"	CN 6-8 ht	37 15/16"	CN 7-0 ht	41 15/16"	CN 8-0 ht	51 7/16"	CN 9-0 ht	63 7/16"	Stainless Steel	05700174 05700176 05700177 05700179 05700191
Height	Top Locking Rod Length														
CN 6-6R ht	35 7/16"														
CN 6-8 ht	37 15/16"														
CN 7-0 ht	41 15/16"														
CN 8-0 ht	51 7/16"														
CN 9-0 ht	63 7/16"														
	Locking Rod Assembly, Bottom for Multi-Point Lock Solid stainless steel rod with 1/4" – 20 threads <table border="0"> <thead> <tr> <th>Height</th> <th>Bottom Locking Rod Length</th> </tr> </thead> <tbody> <tr> <td>CN 6-6R ht*</td> <td>34 9/32"</td> </tr> <tr> <td>CN 6-8 ht</td> <td>34 9/32"</td> </tr> <tr> <td>CN 7-0 ht</td> <td>34 9/32"</td> </tr> <tr> <td>CN 8-0 ht</td> <td>34 9/32"</td> </tr> <tr> <td>CN 9-0 ht</td> <td>34 9/32"</td> </tr> </tbody> </table>	Height	Bottom Locking Rod Length	CN 6-6R ht*	34 9/32"	CN 6-8 ht	34 9/32"	CN 7-0 ht	34 9/32"	CN 8-0 ht	34 9/32"	CN 9-0 ht	34 9/32"	Stainless Steel	05700170
Height	Bottom Locking Rod Length														
CN 6-6R ht*	34 9/32"														
CN 6-8 ht	34 9/32"														
CN 7-0 ht	34 9/32"														
CN 8-0 ht	34 9/32"														
CN 9-0 ht	34 9/32"														

* Can be used for obsolete 6-5 height.

ILLUSTRATION NOT TO SCALE	DESCRIPTION	OPER./COLOR	PART NO.
RH Shown 	End Plug, Flat Casing	Beige LH RH Bronze LH RH	11869852 11869850 11869853 11869851
	Pre 2014 Sill End Plug	Black LH RH	11869836 11869837
	Pre 2014 Sill Outlet Drain Cover	Black	15633100
	Pre 2014 Sill Drain Cover	Beige Bronze	15633101 15633102
	Head Jamb Spacer Tack; Stationary Panel		11860424
	Jamb Spacer Tack; Stationary Panel 3/4" Diameter Head (replaced 7/16" diameter head)		11860423
	Stationary Panel Bracket Wood and Clad Field Service		11860216


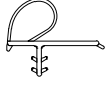



PARTS FOR LOCK STATUS SENSOR

ILLUSTRATION NOT TO SCALE	DESCRIPTION	OPER./ COLOR	PART NO.
	Tailpiece, Non-keyed, Button Switch	Stainless Steel	10501844
	Cover, Transmitter	Brushed Stainless Steel	10501822
	#8-18 x 1" Type AB, Full Thread <i>Used for Transmitter Cover</i> <i>Need quantity of 2 for each part</i>		11800769
	Button Switch Assembly	Black	10501824
	Lock Rod, Transmitter Recess, Shoot Bolt at Sill	Brushed Stainless Steel LH RH	10501839 10501842


WEATHER STRIP AND VINYL

When ordering replacement weather strip or vinyl parts, specify:



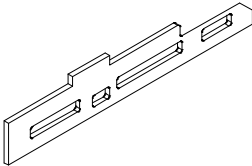
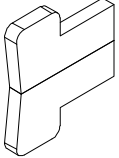

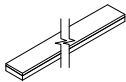
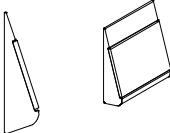
1. quantity;
2. length;
3. part number;
4. description.

ILLUSTRATION <i>NOT TO SCALE</i>	DESCRIPTION	PART NUMBER	PART NUMBER		
	Weather Strip, Sill V2026	Beige	Black		
		47 1/8"	11208440	11208540	
			62 5/16"	11208454	11208554
			82 5/16"	11208470	11208570
			105 1/2"	11208490	11208590
			164 11/16"	11208499	11208599
	Offset Bulb Weather Strip, Parting Stop, Frame, Mull Casing, Transom and Astragal V796	Beige	Black		
		41 1/4"	15171136	--	
			92 7/8"	15170082	15170083
			164 13/16"	15172140	--
			CN 9-0	15170090	15170091
	Weather Strip, Stile V020	Beige	Black		
		CN 6-8	11197968	--	
			CN 8-0	11197982	--
			CN 9-0	11197990	11197991
			Lineal	11197999	11197998
	Weather Strip, Panel Cover V018	Beige	Black		
		150"	11197799	11197798	
	Weather Strip, Inactive V1706	Beige	Black		
		121"	15618199	15618299	

WEATHER STRIP AND VINYL

ILLUSTRATION NOT TO SCALE	DESCRIPTION	PART NUMBER	PART NUMBER
 <p data-bbox="277 810 480 842">Straight end cuts</p>	<p data-bbox="634 317 946 348">Frame Vinyl, Head Jamb</p> <p data-bbox="634 352 711 380">V2114</p> <p data-bbox="1019 384 1133 411">17 11/16"</p> <p data-bbox="1036 415 1133 443">29 5/16"</p> <p data-bbox="1036 447 1133 474">31 5/16"</p> <p data-bbox="1036 478 1133 506">35 5/16"</p> <p data-bbox="1052 510 1133 537">46 1/2"</p> <p data-bbox="1052 541 1133 569">56 7/8"</p> <p data-bbox="1052 573 1133 600">58 1/2"</p> <p data-bbox="1052 604 1133 632">62 1/2"</p> <p data-bbox="1052 636 1133 663">68 7/8"</p> <p data-bbox="1052 667 1133 695">70 1/2"</p> <p data-bbox="1052 699 1133 726">82 1/2"</p> <p data-bbox="1019 730 1133 758">93 11/16"</p> <p data-bbox="1019 762 1133 789">105 11/16"</p> <p data-bbox="1052 793 1133 821">116 7/8"</p> <p data-bbox="1052 825 1133 852">124 7/8"</p> <p data-bbox="1052 856 1133 884">140 7/8"</p> <p data-bbox="1052 888 1133 915">164 7/8"</p>	<p data-bbox="1182 321 1252 348">Beige</p> <p data-bbox="1162 384 1279 411">11208016</p> <p data-bbox="1162 415 1279 443">11208026</p> <p data-bbox="1162 447 1279 474">11208028</p> <p data-bbox="1162 478 1279 506">11208030</p> <p data-bbox="1162 510 1279 537">11208040</p> <p data-bbox="1162 541 1279 569">11208051</p> <p data-bbox="1162 573 1279 600">11208050</p> <p data-bbox="1162 604 1279 632">11208054</p> <p data-bbox="1162 636 1279 663">11208061</p> <p data-bbox="1162 667 1279 695">11208060</p> <p data-bbox="1162 699 1279 726">11208070</p> <p data-bbox="1162 730 1279 758">11208080</p> <p data-bbox="1162 762 1279 789">11208090</p> <p data-bbox="1162 793 1279 821">11208010</p> <p data-bbox="1162 825 1279 852">11208011</p> <p data-bbox="1162 856 1279 884">11208012</p> <p data-bbox="1162 888 1279 915">11208099</p>	<p data-bbox="1336 321 1406 348">Black</p> <p data-bbox="1360 384 1385 411">--</p> <p data-bbox="1317 415 1433 443">11208226</p> <p data-bbox="1317 447 1433 474">11208228</p> <p data-bbox="1317 478 1433 506">11208230</p> <p data-bbox="1317 510 1433 537">11208240</p> <p data-bbox="1360 541 1385 569">--</p> <p data-bbox="1317 573 1433 600">11208250</p> <p data-bbox="1317 604 1433 632">11208254</p> <p data-bbox="1360 636 1385 663">--</p> <p data-bbox="1317 667 1433 695">11208260</p> <p data-bbox="1317 699 1433 726">11208270</p> <p data-bbox="1360 730 1385 758">--</p> <p data-bbox="1317 762 1433 789">11208290</p> <p data-bbox="1360 793 1385 821">--</p> <p data-bbox="1317 825 1433 852">11208211</p> <p data-bbox="1317 856 1433 884">11208212</p> <p data-bbox="1317 888 1433 915">11208299</p>
	<p data-bbox="634 898 938 930">Frame Vinyl, Side Jamb</p> <p data-bbox="634 934 711 961">V2114</p> <p data-bbox="634 966 721 993">Usage:</p> <p data-bbox="634 997 867 1024">1/6/2014 to present</p> <p data-bbox="1019 1024 1133 1052">77 19/32"</p> <p data-bbox="1036 1056 1133 1083">79 3/32"</p> <p data-bbox="1036 1087 1133 1115">83 3/32"</p> <p data-bbox="1019 1119 1133 1146">92 19/32"</p> <p data-bbox="1019 1150 1133 1178">104 19/32"</p>	<p data-bbox="1182 961 1252 989">Beige</p> <p data-bbox="1162 1024 1279 1052">11209466</p> <p data-bbox="1162 1056 1279 1083">11209468</p> <p data-bbox="1162 1087 1279 1115">11209470</p> <p data-bbox="1162 1119 1279 1146">11209480</p> <p data-bbox="1162 1150 1279 1178">11209490</p>	<p data-bbox="1336 961 1406 989">Black</p> <p data-bbox="1317 1024 1433 1052">11209566</p> <p data-bbox="1317 1056 1433 1083">11209568</p> <p data-bbox="1317 1087 1433 1115">11209570</p> <p data-bbox="1317 1119 1433 1146">11209580</p> <p data-bbox="1317 1150 1433 1178">11209590</p>

WEATHER STRIP AND VINYL

ILLUSTRATION <i>NOT TO SCALE</i>	DESCRIPTION	LENGTH	COLOR	PART NUMBER
	<p>Connecting Barb V803 NOTE: Color may vary depending on current stock.</p> <p>Wood Door, Wood and Clad Transom only</p>	Specify Length by LF		15812999
	<p>Dust Block, Part Stop 1 3/8" x 3/8" x 1/2"</p>		Gray Beige	15600010 15600011
	<p>Pre 2014 Gasket, Sill to Jamb 4 9/16" Adhesive backed <i>Includes</i> 1 - LH and 1 - RH</p>		Gray	15600020
	<p>Pre 2014 Corner Gasket Adhesive backed</p>		Black	10500434
	<p>Pre 2014 Gasket, Jamb Weather Strip 3/4" - Header Adhesive backed</p>		Black	10500576
	<p>Butyl Foam Tape 3/16" Width Adhesive backed</p>	25 FT Roll	Black	11406232
	<p>Sill Interior Filler Block V2077</p>		Beige Bronze	11124202 11124203

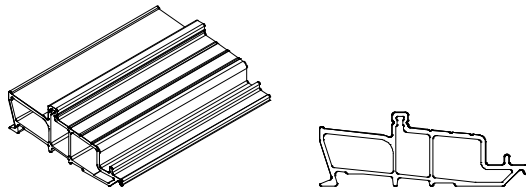
ORDERING REPLACEMENT VINYL, ALUMINUM OR FIBERGLASS PARTS FOR THE ULTIMATE OUTSWING FRENCH DOOR

TO ORDER REPLACEMENT PARTS

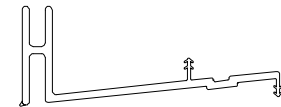
When ordering replacement parts specify:

1. profile number;
2. rough opening;
3. length;
4. handing;
5. finish (where applicable).

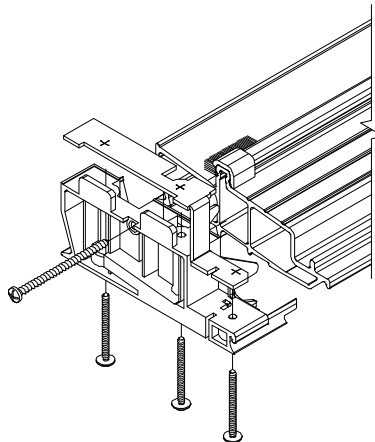
	Wood	Clad
Pre 2014 Ultrex Sill, 4 9/16" Jamb (includes weep system, sill liner and Weather Strip) – Beige or Bronze	F2050	F2050
2014 Ultrex Sill, 4 9/16" Jamb – Beige or Bronze	F2050	F2050
Sash Retainer (Transom) – Black	V026	V026
Sill Leveling Block (Transom) – Beige or Black	V2109	V2109
Active Astragal	A732	---



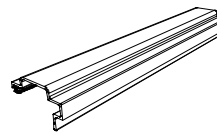
F2050 – Pre 2014 Ultrex Sill,
4 9/16" Jamb



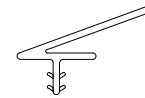
V2109 – Sill
Leveling Block
(In-Sash Transom)



F2050 – 2014 Ultrex Sill,
4 9/16" Jamb



A732 – Active
Astragal



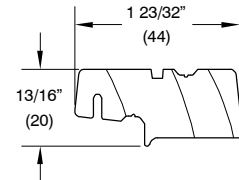
V026 – Sash
Retainer
(Transom)

TO ORDER REPLACEMENT WOOD PARTS FOR ULTIMATE OUTSWING FRENCH DOOR

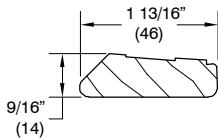
When ordering replacement wood parts specify:

1. profile number;
2. rough opening;
3. handing;
4. length;
5. finish;
6. radius (if applicable).

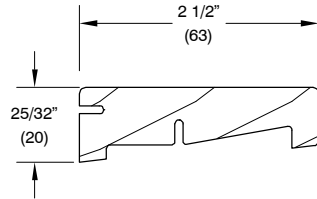
	Wood	Clad
Mulling Case Base	W10860	W10860
Sill Cover (Mahogany/Red Oak)	W10919	W10919
Sill Cover – In-Sash Transom	W11398	W11398
Sill Liner (Mahogany/Red Oak)	W10935	W10935
Jamb Stop	W11409	W11409
Mull Casing Cover	W10861	W10861
Sill Nosing – Transom – June 24, 2013 – present	W12059	
Top Rail Block – In-Sash Transom	W11533	W11533
Interior Glazing Bead Direct Glaze Transom June 24, 2013 – present	W11751	W11751
Interior Glazing Bead Direct Glaze Transom Pre-June 24, 2013	W4160	W4160



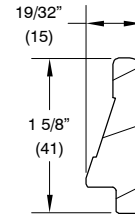
W10860 – Mulling Case Base



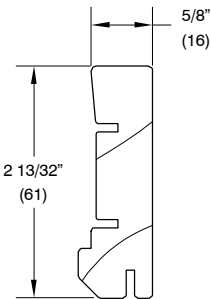
W10919 – Sill Cover
 Oak – Standard
 Cherry or Mahogany – Optional



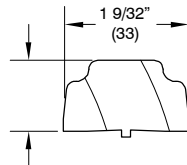
W11398 – Sill Cover Transom



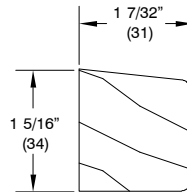
W10935 – Sill Liner
 Oak – Standard
 Cherry or Mahogany – Optional



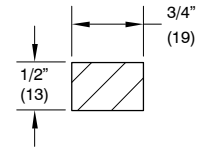
W11409 – Jamb Stop



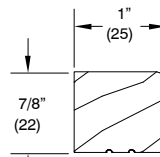
W10861 – Mull Case Cover



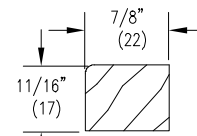
W12059 – Sill Nosing Transom



W11533 – Top Rail Block



W11751

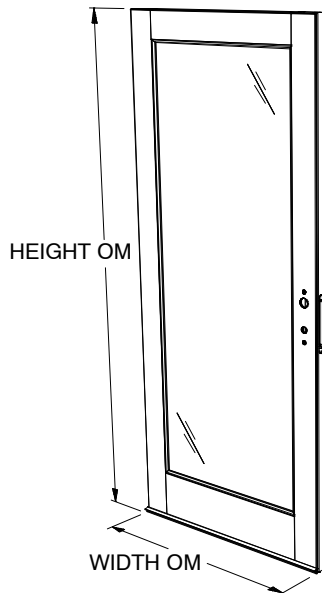


W4160

ORDERING REPLACEMENT PANELS FOR THE WOOD AND CLAD ULTIMATE OUTSWING FRENCH DOOR

To order replacement panels specify:

1. OM of panel;
NOTE: OM of panel does not include astragal, mull casing or sweep.
2. active, inactive or stationary
 - a. Active – specify no lock (no bore), bore for passage latch/dead bolt, single–point mortise lock or multi–point mortise lock .
 - b. Inactive – specify head or foot bolts or multi–point mortise lock. For inactive panels with head bolts, if panel being replaced was manufactured before 8/28/16 and panel height OM is greater than 95” order appropriate Inactive Panel Top Flush Bolt Assembly.
 - c. Stationary – specify configuration and astragal or mull casing (if applicable).
 - d. Panel style.
3. handing;
4. glazing;
5. finish;
6. glazing bead profile
 - a. bevel
 - b. square



**Wood Active Panel
Exterior View**



**Clad Active Panel
Exterior View**

NOTE: Weather Strip is included with all panels (where applicable).

Active panels include panel sweep, bored for passage/dead bolt, single–point mortise lock, or multi–point mortise lock system.

Inactive panels include panel sweep, astragal, configured for head and foot bolts or multi–point lock system.

Stationary 1 wide panels include panel sweep and sill bolts.

Stationary 2, 3 or 4 wide panels include panel sweep, sill bolts and mull casing.

ORDERING ENERGY PANELS FOR SINGLE GLAZED WOOD ULTIMATE OUTSWING FRENCH DOOR

If you are replacing an existing energy panel, determine the outside measurement of the existing energy panel. Find the sizes that correspond to the width and height indicated on the following chart. Energy panels are available for the single glazed Wood Ultimate Outswing French Doors. Aluminum surrounds are available in bronze or stone white.

Energy panels are attached with turn buttons. Turn button styles may vary depending on current stock. You will receive the most current style in the color of your choice. (Discontinued black turn buttons will be replaced by brown.) Turn buttons can be found in the Miscellaneous Mouldings chapter of the Parts Manual

When ordering energy panels specify:

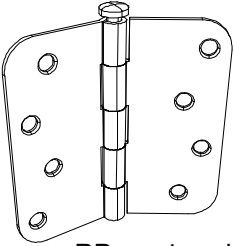
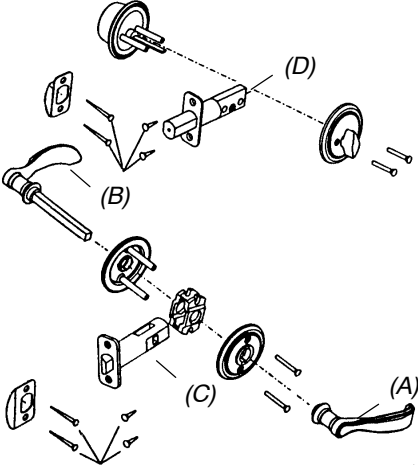
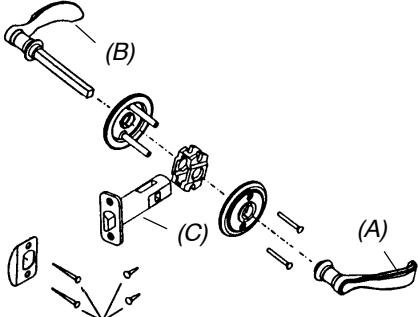
1. size; If there is no existing EP from which to obtain the OM of the panel, determine the size of the EP by using the conversion chart below. The daylight opening is the measurement of the visible glass.
2. color of surround;
3. glass type;

Single Glazed Wood Ultimate Outswing				
Wood Ultimate Outswing French Doors				
manufactured 1/17/00 – Present				
Daylight Opening to OM of EP				
Daylight Width + 1 3/8" = OM Width of EP				
Daylight Height + 1 3/8" = OM Height of EP				
WIDTH			HEIGHT	
SIZE	(65 ht.)	OM-WIDTH	SIZE	OM-HEIGHT
CN 16		12 7/8"	CN 65	64 1/4"
CN 26		19 15/32"		
CN 30		25 15/32"		
CN 16	(66R ht.)	12 7/8"	CN 66R	65"
CN 26R		20 5/32"		
CN 30R		26 5/32"		
CN 16		12 7/8"	CN 68	67 1/2"
CN 20		14 31/32"	CN 70	71 1/2"
CN 26		20 31/32"	CN 80	81"
CN 28		22 31/32"		
CN 30		26 31/32"		
CN 36		32 31/32"		

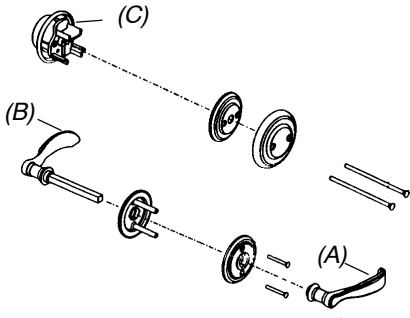
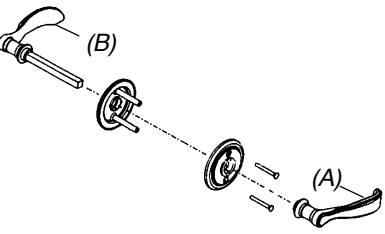
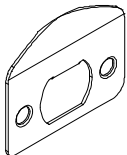
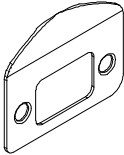
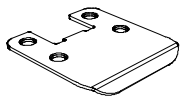
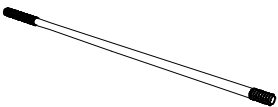

OBSOLETE PARTS

When ordering replacement parts specify:



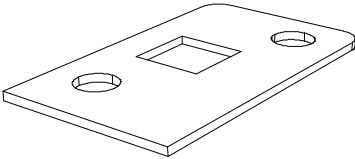
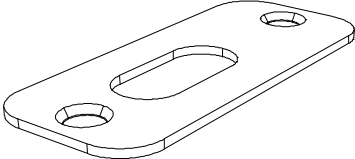

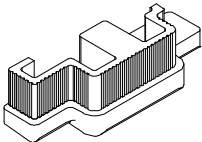
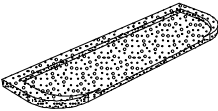
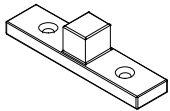
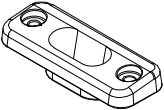
1. type of unit;
2. part number;
3. description.

ILLUSTRATION NOT TO SCALE	DESCRIPTION	OPER./CO LOR	PART NO.
 <p>RP version shown</p>	<p>Hinge, Outswing Doors Wood Outswing French Door 1989 – 1/17/00. Clad Outswing French Door 1990 – 1/17/00. Includes: 1 – 4” hinge 4 – #10x1” Phillips flathead wood screws (panel) 3 – #10x3/4” Phillips flathead wood screws (frame) 1 – #10x2 1/2” Phillips flathead wood screws (frame) Brass</p>	<p><u>Solid Brass</u> RP <u>SS</u> NRP RP</p>	<p>NA</p>
	<p>Lever Set, Complete, Solid Brass Wood Outswing French Door 1989 – 1/17/00. Clad Outswing French Door 1990 – 1/17/00. Schlage “C” Keyway Includes: 1 – Solid brass interior passage handle (A) 1 – Solid brass exterior passage handle (B) with spindle 1 – Passage latch assembly (C) with cover plates and 05700003 strike plate 1 – Deadbolt assembly (D) with cover plates and 05700002 strike plate 2 – Keys 1 – Installation screw package with Allen wrench and instructions</p>		<p>NA</p>
	<p>Lever Set, Solid Brass Wood Outswing French Door 1989 – 1/17/00. Clad Outswing French Door 1990 – 1/17/00. Includes: 1 – Solid brass interior passage handle (A) 1 – Solid brass exterior passage handle (B) with spindle 1 – Passage latch assembly (C) with cover plates and 05700003 strike plate 1 – Installation screw package with Allen wrench and instructions</p>		<p>N/A</p>

OBSOLETE PARTS

ILLUSTRATION NOT TO SCALE	DESCRIPTION	OPER./CO LOR	PART NO.
	<p>Lever Set, Dummy (with dummy deadbolt), Solid Brass Wood Outswing French Door 1989 – 1/17/00. Clad Outswing French Door 1990 – 1/17/00. Includes: 1 – Solid brass dummy interior passage handle (A) with cover plate 1 – Solid brass dummy exterior passage handle (B) with spindle and cover plate 1 – Dummy deadbolt assembly (C) with cover plate 1 – Installation screw package with instructions</p>		NA
	<p>Lever Set, Dummy, Solid Brass Wood Outswing French Door 1989 – 1/17/00. Clad Outswing French Door 1990 – 1/17/00. Includes: 1 – Solid brass dummy interior passage handle (A) with cover plate 1 – Solid brass dummy exterior passage handle (B) with spindle and cover plate 1 – Installation screw package with instructions</p>		NA
	<p>Strike Plate, Lever Set, Solid Brass Wood Outswing French Door 1989 – 1/17/00. Clad Outswing French Door 1990 – 1/17/00. Includes: 1 – Strike plate 2 – #6x2” Phillips flathead wood screws</p>		NA
	<p>Strike Plate, Deadbolt, Solid Brass Wood Outswing French Door 1989 – 1/17/00. Clad Outswing French Door 1990 – 1/17/00. Includes: 1 – Strike plate 2 – #6x2” Phillips flathead wood screws</p>		NA
	<p>Strike Plate, Lever Set, Solid Brass Wood Ultimate Outswing French Door 1989 – 1/17/00. Clad Outswing French Door 1990 – 1/17/00. For single panel door Includes: 1 – Strike plate 4 – #6x2” Phillips flathead wood screws</p>		NA
	<p>Extension Rod Wood Outswing French Door 1989 – 1/17/00. Clad Outswing French Door 1990 – 1/17/00. For head or foot bolt</p> <p style="text-align: right;">9 11/16” 25 11/16”</p>		16152002 NA
	<p>Stop clip with screws NA as individual part – 02–2011</p>		NA

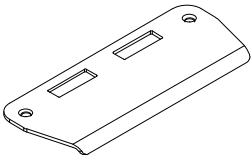
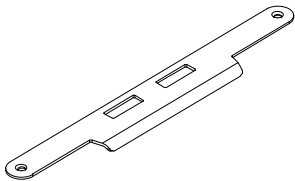

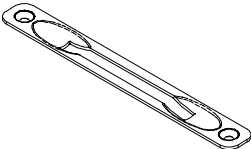
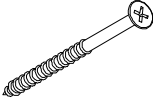
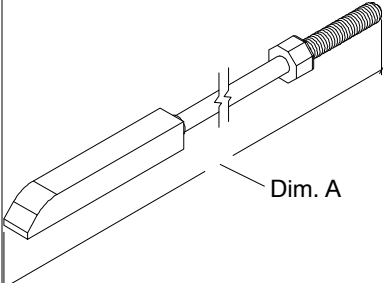
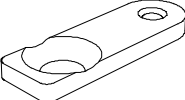
OBSOLETE PARTS

ILLUSTRATION NOT TO SCALE	DESCRIPTION	OPER./ COLOR	PART NO.
	<p>Inactive Panel Flush Bolt <i>3/16" radius corners, replace with current flush bolt (1/4" radius corners)</i> Includes: 1 – Flush bolt 4 – #6 x 1 1/2" Phillips flathead wood screws</p>	Brass Antique Brass Polished Chrome Brushed Chrome White	NA
	<p>End Bolt – Head/Foot Bolt <i>Wood Outswing French Door 1989 – 1/17/00. Clad Outswing French Door 1990 – 1/17/00.</i></p>		NA
	<p>Head or Foot Bolt Guide Plate <i>Wood Ultimate Outswing French Door 1989 – 1/17/00. Clad Outswing French Door 1990 – 1/17/00.</i> Includes: 1 – Guide plate 2 – #6x1 1/2" Phillips flathead wood screws</p>	ZYD	NA
	<p>Head or Foot Bolt Strike Plate <i>Wood Outswing French Door 1989 – 1/17/00. Clad Outswing French Door 1990 – 1/17/00.</i> Includes: 1 – Foot bolt guide plate 2 – #6x3/8" Phillips flathead wood screws</p>	Solid Brass Polished Chrome Brushed Chrome	N/A
	<p>Foot Bolt Receiver Cup <i>Wood Outswing French Door 1989 – 1/17/00. Clad Outswing French Door 1990 – 1/17/00.</i></p>	Beige	NA
	<p>Active Astragal Bottom Cap <i>Clad Outswing French Door 1990 – 1/17/00.</i> Clad Outswing door only</p>	Beige LH RH	11867701 11867700
	<p>Hinge Pocket Gasket, Butyl <i>Clad Outswing French Door 1990 – 1/17/00.</i> Clad Outswing door only</p>		NA
	<p>Sill Bolt, Stationary Panel (pre 07/2012) Includes: 2 – #8 x 3" Phillips flathead wood screws</p>	Zinc Die Cast	NA
	<p>Strike, Sill (pre 07/2012) Includes: 1 – Strike plate 2 – #8 x 5/8" Phillips trusshead stainless steel machine screws (sill) 2 – Well-nut threaded insert (10830008)</p>	Beige Bronze	18900365 18900368

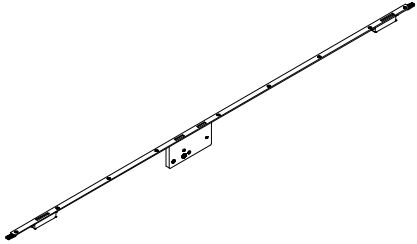
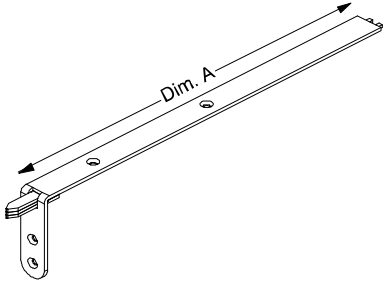
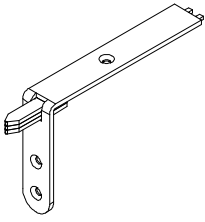
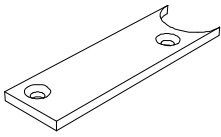
OBSOLETE PARTS

ILLUSTRATION NOT TO SCALE	DESCRIPTION	OPER./CO LOR	PART NO.
	<p>Multi-Point Handle, Active, Solid Brass (Essve) Wood Outswing French Door 1989 – 1/17/00. Clad Outswing French Door 1990 – 1/17/00. (Weiser keyway before 7/97) (Schlage keyway 7/97 to present) Includes: 1 – Interior handle (A) with escutcheon plate and thumb turn 1 – Exterior handle (B) with escutcheon plate and keyed cylinder 1 – Spindle (C) 2 – Escutcheon mounting extensions (D) 1 – Jamb strike (center) (E) 2 – Keys 2 – #10 – 24x1 1/2" Phillips ovalhead machine screws 4 – #7x5/8" Phillips flathead wood screws (Strike)</p>	<p>LH RH</p>	<p>NA (Current handle can be used by turning it upside down)</p>
	<p>Multi-Point Handle, Inactive, Solid Brass (Essve) Wood Outswing French Door 1989 – 1/17/00. Clad Outswing French Door 1990 – 1/17/00. Includes: 1 – Interior handle (A) with escutcheon plate 1 – Exterior handle (B) with escutcheon plate 1 – Spindle (C) 2 – Escutcheon mounting extensions (D) 2 – #10–24x1 1/2" Phillips ovalhead machine screws</p>	<p>LH RH</p>	<p>NA (Current handle can be used by turning it upside down)</p>
	<p>Spindle Package for Multi-Point Handle (Essve) Wood Outswing French Door 1989 – 1/17/00. Clad Outswing French Door 1990 – 1/17/00. Includes: 1 - Spindle 2 - Escutcheon mounting extensions</p>		<p>NA</p>
	<p>Active Multi-Point Hardware Assembly (Essve) Wood Outswing French Door 1989 – 1/17/00. Clad Outswing French Door 1990 – 1/17/00. Includes: 1 – Multi-Point hardware assembly (with mortise locks) 9 – #6x1 1/2" Phillips flathead wood screws</p> <p>CN 6-5, 6-8 or 7-0 ht. CN 8-0 ht.</p>	<p>LH RH LH RH</p>	<p>NA</p>

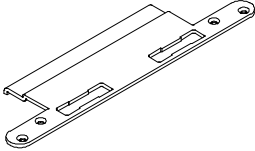
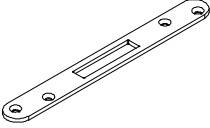
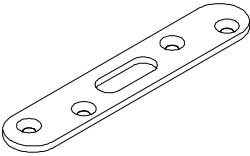

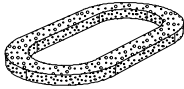
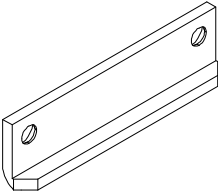
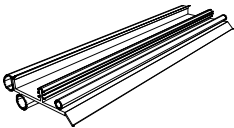
OBSOLETE PARTS

ILLUSTRATION NOT TO SCALE	DESCRIPTION	OPER./COLOR	PART NO.				
	<p>Strike Plate, Jamb – Mortise Lock or Multi-Point Lock 1/17/00 – 3/31/03(Amerock) Includes: 1 – Jamb strike plate 2 – #8x1” Brass Phillips flathead wood screws</p>	Polished Chrome Brushed Chrome White	NA				
	<p>Strike Plate, Panel – Mortise Lock or Multi-Point Lock 1/17/00 – 3/31/03 (Amerock) Includes: 1 – Jamb strike plate 2 – #8x1” Brass Phillips flathead wood screws</p>	Polished Chrome Brushed Chrome White	NA				
	<p>Cover Plate, Active Panel – Mortise Lock or Multi-Point Lock 1/17/00 – 3/31/03 (Amerock) Includes: 1 – Cover plate 2 – #8x1” Phillips flathead wood screws</p>	Polished Chrome Brushed Chrome White	NA				
	<p>Cover Plate for Flush Bolt Includes: 1 – Cover plate 2 – #9 x 1” Screws</p>	Polished Chrome Brushed Chrome White Brass Antique Brass PVD Brass	NA				
	<p>Installation Screw Package; Strike Plate(s) at head jamb, or locking jamb FD – std. UFD – std. #8 x 3” Flathead wood screw Package of 4</p>	White	11882348				
	<p>Locking Rod Assembly, Top – Multi-Point Lock 3/02– Present (Amerock) 8–0 Height see History 5/10/90 – Present (Amerock) 6–5, 6–8, & 7–0 Height Solid stainless steel rod with 1/4” – 20 threads NOTE: For special heights give dimension A.</p> <table border="1" data-bbox="581 1625 899 1717"> <thead> <tr> <th>Height</th> <th>Top Locking Rod Length</th> </tr> </thead> <tbody> <tr> <td>CN 6–5 ht</td> <td>34 11/16”</td> </tr> </tbody> </table>	Height	Top Locking Rod Length	CN 6–5 ht	34 11/16”	Stainless Steel	NA
Height	Top Locking Rod Length						
CN 6–5 ht	34 11/16”						
	<p>Inactive Panel Backset Extension – Head or Foot Flush Bolt With 1/4” – 20 threads Includes: 1 – Backset extension 1 – 1/4” –20 x3/4” Phillips flathead machine screw</p>		NA				

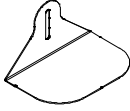
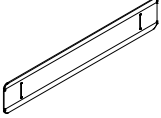
OBSOLETE PARTS

ILLUSTRATION NOT TO SCALE	DESCRIPTION	OPER./COLOR	PART NO.
	<p>Inactive Multi-Point Hardware Assembly (Essve) Wood Outswing French Door 1989 – 1/17/00. Clad Outswing French Door 1990 – 1/17/00. Includes: 1 – Inactive multi-point hardware assembly 9 – #6X1 1/2" phillips flathead wood screws CN 6-5, 6-8 and 7-0 ht. CN 8-0 ht.</p>		NA
	<p>Multi-Point Top Corner Drive (Essve) Wood Ultimate Outswing French Door 1989 – 1/17/00. Clad Outswing French Door 1990 – 1/17/00. For Inactive panel with multi-point Includes: 1 – Top corner drive Attached with #6x1/2" Phillips flathead wood screws CN 6-8 ht. 7 29/64" (189) CN 7-0 ht. 11 15/32" (291) CN 8-0 ht. 10 5/16" (262) CN 6-5 ht. 3 3/4" (95) NOTE: For special heights give Dimension A.</p>		NA
	<p>Multi-Point Bottom Corner Drive (Essve) Wood Outswing French Door 1989 – 1/17/00. Clad Outswing French Door 1990 – 1/17/00. For Inactive panel with multi-point 4 13/32" (112) Includes: 1 – Bottom corner drive 3 – #6x1/2" Phillips flathead wood screws</p>		NA
	<p>Corner Drive Filler; Multi-Point Lock (Essve) Wood Outswing French Door 1989 – 1/17/00. Clad Outswing French Door 1990 – 1/17/00. Includes: 1 – Corner drive filler 2 – #6 x 1 1/2" Phillips flathead wood screws</p>		NA

OBSOLETE PARTS


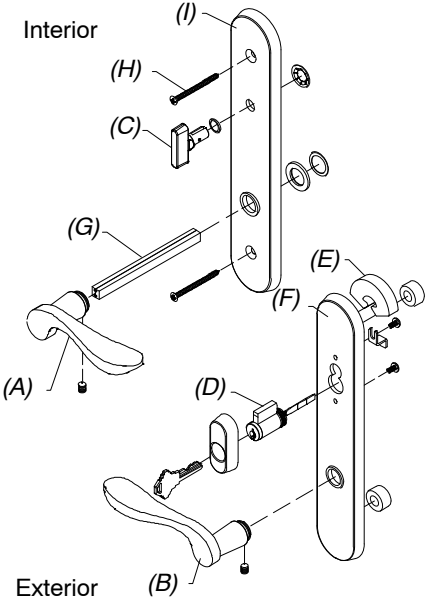
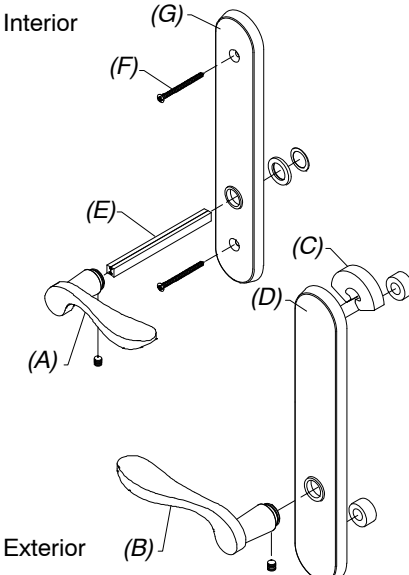
ILLUSTRATION NOT TO SCALE	DESCRIPTION	PART NO.
	<p>Jamb Strike, Center, Solid Brass; Multi-Point Lock (Essve) <i>Wood Outswing French Door 1989 – 1/17/00.</i> <i>Clad Outswing French Door 1990 – 1/17/00.</i> Includes: 1 – Jamb strike 4 – #7 x 5/8" Phillips flathead wood screws</p>	NA
	<p>Jamb Strike, Center, Extended, Solid Brass; Multi-Point Lock (Essve) <i>Wood Outswing French Door 1989 – 1/17/00.</i> <i>Clad Outswing French Door 1990 – 1/17/00.</i> Includes: 1 – Extended jamb strike 4 – #7x5/8" Phillips flathead wood screws</p>	NA
	<p>Jamb Strike, Top or Bottom, Solid Brass; Multi-Point Lock (Essve) <i>Wood Outswing French Door 1989 – 1/17/00.</i> <i>Clad Outswing French Door 1990 – 1/17/00.</i> Includes: 1 – Jamb strike 4 – #7 x 5/8 Phillips flathead screws</p>	NA
	<p>Strike, Inactive Panel, Head Jamb; Multi-Point Lock (Essve) <i>Wood Outswing French Door 1989 – 1/17/00.</i> <i>Clad Outswing French Door 1990 – 1/17/00.</i> Includes: 1 – Strike 4 – #7x5/8" Phillips flathead wood screws</p>	NA
	<p>Corner Drive Sill Receptacle, Solid Brass; Multi-Point Lock (Essve) <i>Wood Outswing French Door 1989 – 1/17/00.</i> <i>Clad Outswing French Door 1990 – 1/17/00.</i></p>	NA
	<p>Sill Receptacle Gasket; Multi-Point Lock <i>Wood Outswing French Door 1989 – 1/17/00.</i> <i>Clad Outswing French Door 1990 – 1/17/00.</i> For corner drive sill receptacle</p>	NA
	<p>Astragal Strike Latch; Multi-Point Lock (Essve) <i>Wood Outswing French Door 1989 – 1/17/00.</i> <i>Clad Outswing French Door 1990 – 1/17/00.</i> Inactive panel with multi-point hardware Includes: 1 – Latch 2 – #7x5/8" Phillips flathead wood screws</p>	NA
	<p>Sweep V212 <i>Wood Outswing French Door 1989 – 1/17/00.</i> <i>Clad Outswing French Door 1990 – 1/17/00.</i></p>	NA

OUTSWING FRENCH DOORS / ULTIMATE OUTSWING FRENCH DOOR
OBSOLETE PARTS

ILLUSTRATION <i>NOT TO SCALE</i>	DESCRIPTION	OPER./COLOR	PART NO.
	Bracket, Jamb-Align		N/A
	Receiver, Jamb Align		N/A

OBSOLETE PARTS

ILLUSTRATION NOT TO SCALE	DESCRIPTION	OPER./ COLOR	PART NO.
	<p>Contemporary Handle Assembly, Active Panel Mortise lock and Multi-point lock systems (Schlage "C" keyway) Includes: 1 - Interior lever (A) with 10148414 spindle, escutcheon plate and hardware 1 - Exterior lever (B) with escutcheon plate and hardware 1 - Thumb turn (C) with hardware 1 - Keyed cylinder (D) with housing and hardware 1 - Exterior escutcheon plate gasket (E) 1 - Exterior escutcheon plate (F) 1 - Two piece spindle (G) 2 - M5 x 55mm Phillips ovalhead machine screws (H) 1 - Interior escutcheon plate (I) 1 - Thumb turn washer (J) 1 - Thumb turn push nut (K) 2 - Keys</p>	Satin Taupe	11102150
	<p>Contemporary Handle Assembly, Inactive/Dummy Includes: 1 - Interior lever (A) with spindle, escutcheon plate and hardware 1 - Exterior lever (B) with escutcheon plate and hardware 1 - Exterior escutcheon plate gasket (C) 1 - Exterior escutcheon plate (D) 1 - Two piece spindle (E) 2 - M5 x 55mm Phillips ovalhead machine screws (F) 1 - Interior escutcheon plate (G)</p>	Satin Taupe	11102153
	<p>Thumb Turn (C) NOTE: For each thumb turn, order one thumb turn washer -10148423(J) and one thumb turn push nut 10148424(K).</p>	Satin Taupe	10148425

ILLUSTRATION NOT TO SCALE	DESCRIPTION	OPER./COLOR	PART NO.
	<p>Head or Foot Flush Bolt – Inactive Panel OLCD, FD, UFD, std.</p> <p>Includes: 1 – Head or foot bolt 4 – #6 x 3/4" Phillips flathead wood screws</p>	<p>Bright Brass Antique Brass Polished Chrome White</p>	<p>11101765 NA NA NA</p>
	<p>Handle Assembly, Active Panel Mortise Lock and Multi-Point Locks (Schlage "C" keyway)</p> <p>Includes: 1 – Interior lever (A) with 00142006 spindle, escutcheon plate and hardware 1 – Exterior lever (B) with escutcheon plate and hardware 1 – Thumb turn (C) with hardware 1 – Keyed cylinder (D) with housing and hardware 1 – Exterior escutcheon plate gasket (E) 1 – Exterior escutcheon plate (F) 1 – Two piece spindle (G) 2 – #10–32x2" Phillips ovalhead machine screws (H) 1 – Interior Escutcheon plate (I) 2 – Keys</p>	<p>Polished Chrome Brushed Chrome</p>	<p>10148117 10148118</p>
	<p>Handle Assembly, Inactive/Dummy Inactive Panel with Flush bolts</p> <p>Includes: 1 – Interior lever (A) with 00142006 spindle, escutcheon plate and hardware 1 – Exterior lever (B) with escutcheon plate and hardware 1 – Exterior escutcheon plate gasket (C) 1 – Exterior escutcheon plate (D) 1 – Two piece spindle (E) 2 – #10–32x2" Phillips ovalhead machine screws (F) 1 – Interior Escutcheon plate (G)</p>	<p>Polished Chrome Brushed Chrome</p>	<p>10148148 10148149</p>

OBSOLETE PARTS

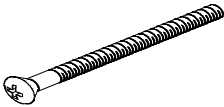
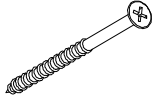
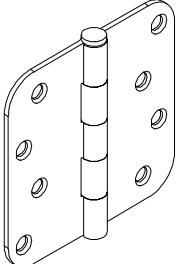
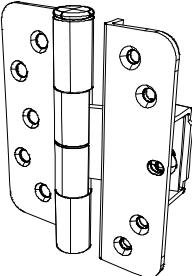
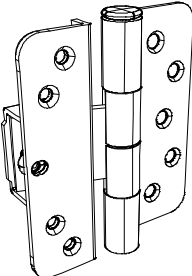
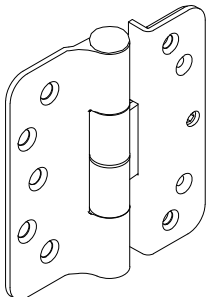
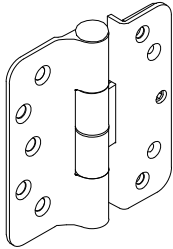
ILLUSTRATION NOT TO SCALE	DESCRIPTION	OPER./COLOR	PART NO.
	#10-32x2" Phillips ovalhead machine screws	Polished Chrome	NA
	Installation Screw Package; Strike Plate(s) at head jamb, sill, or locking jamb #8 x 2 1/2" Flathead wood screw Package of 4	White	11882348
	Hinge, Ball Bearing OLCD Includes: 1 - Ball bearing hinge 8 - #12 x 1 1/4" Phillips flathead wood screws NOTE: Screws are packaged with hinges from manufacturer, no part number available.	Solid Brass Satin Chrome	02100578 NA
	Hinge, Adjustable, Left Hand 2000-2005 Includes: 1 - #10 x 2 1/2" Phillips flathead wood screws (jamb) 4 - #10 x 1" Phillips flathead wood screws (jamb) or 5 - #10 x 1" Phillips flathead wood screws (stationary stile) 4 - #8 x 1 1/2" Phillips flathead wood screws (panel) 1 - 5/32" Allen wrench (adjustment)	Polished Chrome Satin Taupe Gold Tone Silver Frost Dark Bronze White	NA Use pre-2012 hinge <i>Note: The current adjustable hinge kit may also be used. If using the current hinge, all hinges on the panel must be changed.</i>
	Hinge, Adjustable, Right Hand 2000-2005 Includes: 1 - #10 x 2 1/2" Phillips flathead wood screws (jamb) 4 - #10 x 1" Phillips flathead wood screws (jamb) or 5 - #10 x 1" Phillips flathead wood screws (stationary stile) 4 - #8 x 1 1/2" Phillips flathead wood screws (panel) 1 - 5/32" Allen wrench (adjustment)	Polished Chrome Satin Taupe Gold Tone Silver Frost Dark Bronze White	NA Use pre-2012 hinge <i>Note: The current adjustable hinge kit may also be used. If using the current hinge, all hinges on the panel must be changed.</i>
	Hinge, Adjustable Includes: 1 - #10x2 1/2" Phillips flathead wood screws (jamb) 4 - #10x1" Phillips flathead wood screws (jamb) or 5 - #10x1" Phillips flathead wood screws (stationary stile) 4 - #8x1 1/2" Phillips flathead wood screws (panel) 1 - 5/32" Allen wrench (adjustment)	Polished Chrome	NA

ILLUSTRATION NOT TO SCALE	DESCRIPTION				
	<p>Hinge, Adjustable USAGE: Pre-2012 Includes: 1 – Adjustable hinge 1 – #10x2 1/2" Phillips flathead wood screws (jamb) 5 – #10x1" Phillips flathead wood screws 4 – #8x1 1/2" Phillips flathead wood screws</p> <p>NOTE: Hinge part number includes the color matched screws. If you need to order the screws separately, they are listed below aligned with the corresponding hinge color.</p>				
SCREW DESCRIPTION	HINGE COLOR/PART NO.			SCREW COLOR/PART NO.	
		LH	RH		
#10x2 1/2" Phillips flathead wood screws (jamb). Quantity of 1 needed per hinge.	Satin Taupe (TP)	NA**	NA**	Satin Taupe (TP)	11800683
	Goldtone (GT)	NA**	NA**	Goldtone (GT)	11800681
	Satin Frost (SF)	NA**	NA**	Stainless Steel (SS)	11800684
	Dark Bronze (DKBZ)*	NA**	NA**	Dark Bronze (DKBZ)	11800680
	Dark Bronze (DKBZ)	NA**	NA**	Dark Bronze (DKBZ)	11800680
	Antique Brass (AB)	NA**	NA**	Dark Bronze (DKBZ)	11800680
	White (WH)	NA**	NA**	White (WH)	11800682
	Satin Chrome (SC)	NA**	NA**	Stainless Steel (SS)	11800684
	Oil Rubbed Bronze (ORBZ)	NA**	NA**	Dark Bronze (DKBZ)	11800680
	Oil Rubbed Bronze (ORBZ) PVD	NA**	NA**	Dark Bronze (DKBZ)	11800680
	Brass (BS) PVD	NA**	NA**	Brass (BS) PVD	11800679
	Satin Nickel (SN) PVD	NA**	NA**	Stainless Steel (SS)	11800684
#10x1" Phillips flathead wood screws. Quantity of 5 needed per hinge.	TP	NA**	NA**	TP	05580145
	GT	NA**	NA**	GT	11800606
	SF	NA**	NA**	SS	11800605
	DKBZ*	NA**	NA**	DKBZ	02050526
	DKBZ	NA**	NA**	DKBZ	02050526
	AB	NA**	NA**	DKBZ	02050526
	WH	NA**	NA**	WH	11800603
	SC	NA**	NA**	SS	11800605
	ORBZ	NA**	NA**	DKBZ	02050526
	ORBZ PVD	NA**	NA**	DKBZ	02050526
	BS PVD	NA**	NA**	BS PVD	11800600
	SN PVD	NA**	NA**	SS	11800605
#8x1 1/2" Phillips flathead wood screws (panel). Quantity of 4 needed per hinge.	TP	NA**	NA**	TP	11865177
	GT	NA**	NA**	GT	11865172
	SF	NA**	NA**	SS	11865175
	DKBZ*	NA**	NA**	DKBZ	02058013
	DKBZ	NA**	NA**	DKBZ	02058013
	AB	NA**	NA**	DKBZ	02058013
	WH	NA**	NA**	WH	11865173
	SC	NA**	NA**	SS	11865175
	ORBZ	NA**	NA**	DKBZ	02058013
	ORBZ PVD	NA**	NA**	DKBZ	02058013
	BS PVD	NA**	NA**	BS PVD	11865176
	SN PVD	NA**	NA**	SS	11865175

* Used prior to April, 2010

** Contact your Marvin representative.

OBSOLETE PARTS

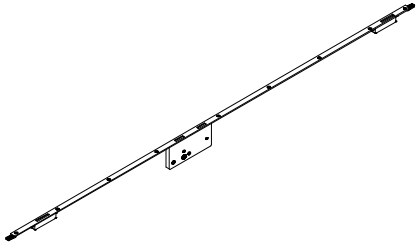
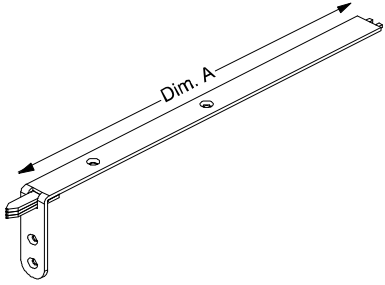
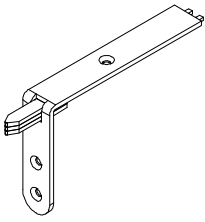

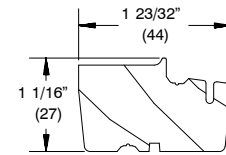
ILLUSTRATION NOT TO SCALE	DESCRIPTION	OPER./COLOR	PART NO.
	<p>Inactive Multi-Point Hardware Assembly (Essve) <i>Wood Outswing French Door 1989 – 1/17/00.</i> <i>Clad Outswing French Door 1990 – 1/17/00.</i> Includes: 1 – Inactive multi-point hardware assembly 9 – #6X1 1/2" phillips flathead wood screws CN 6-5, 6-8 and 7-0 ht. CN 8-0 ht.</p>		NA
	<p>Multi-Point Top Corner Drive (Essve) <i>Wood Ultimate Outswing French Door 1989 – 1/17/00.</i> <i>Clad Outswing French Door 1990 – 1/17/00.</i> For Inactive panel with multi-point Includes: 1 – Top corner drive Attached with #6x1/2" Phillips flathead wood screws CN 6-8 ht. 7 29/64" (189) CN 7-0 ht. 11 15/32" (291) CN 8-0 ht. 10 5/16" (262) CN 6-5 ht. 3 3/4" (95) NOTE: For special heights give Dimension A.</p>		NA
	<p>Multi-Point Bottom Corner Drive (Essve) <i>Wood Outswing French Door 1989 – 1/17/00.</i> <i>Clad Outswing French Door 1990 – 1/17/00.</i> For Inactive panel with multi-point 4 13/32" (112) Includes: 1 – Bottom corner drive 3 – #6x1/2" Phillips flathead wood screws</p>		NA

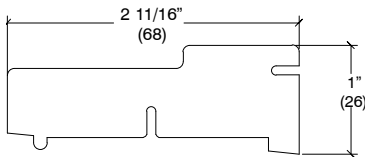
ILLUSTRATION NOT TO SCALE	DESCRIPTION	OPER./COLOR	PART NO.
	Sill Cover W9510 "Pre 2012"	<u>Oak</u> 36" (914) 72" (1829) 96" (2438)	71400936 NA 71400996
		<u>Mahogany</u> 36" (914) 72" (1829) 96" (2438)	71400937 71400973 NA

ULTIMATE OUTSWING FRENCH DOOR – PRE-2012

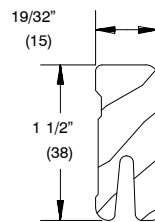
	Wood	Clad
First Mull Casing and Astragal	W1455	
Sill Cover – Transom	W2136	W2136
Sill Liner (oak)	W2528	W2528
Jamb Stop	W6531	W6531
Astragal Cover and Transom Mull Cover	W7554	
Stationary Sweep Filler	W12495	
Sill Nosing – Transom – Pre-June 24, 2013	W8653	
Exterior Part Stop – Transom – Pre-June 24, 2013	W8474	



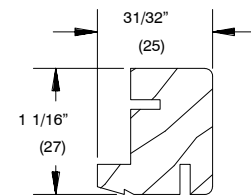
W1455 – First Mull Casing and Astragal– Wood



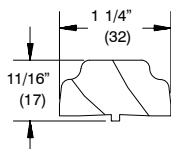
W2136 – Sill Cover Transom



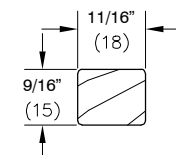
W2528 – Sill Liner (oak)



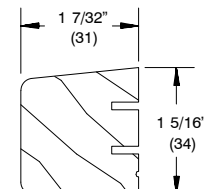
W6531 – Jamb Stop



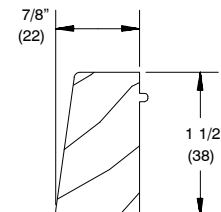
W7554 – Astragal Cover and Transom Mull Cover – Wood



W12495 – Stationary Sweep Filler



W8653 – Sill Nosing Transom – Pre-June 24, 2013



W8474 – Exterior Part Stop Transom Pre-June 24, 2013

TO ORDER REPLACEMENT WOOD PARTS

When ordering replacement wood parts specify:

1. profile number;
2. rough opening;
3. handing;
4. length;
5. finish;
6. radius (if applicable).

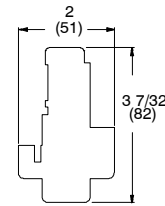
REPLACEMENT WOOD PARTS

OUTSWING FRENCH DOOR

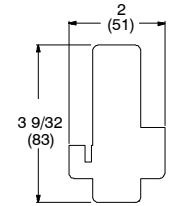
Wood Ultimate Outswing French Door 1989 – 1/17/00.
Clad Outswing French Door 1990 – 1/17/00.

	Clad	Wood
Astragal	W7232	W7222
Astragal (Multi-Point)	W7233	W7219
Operator First Mull Casing	W1092	W1092
Second Mull Casing	W1081	W1081
Stationary Head Jamb, Jamb and Astragal Filler	W6040*	W6040*
Stationary Head Jamb and Jamb Spacer	W6220*	W6220*
Stationary Jamb Filler (1 panel)	W7234*	W7234*
Stationary Jamb Filler (Multi-panel)	W7235*	W7235*

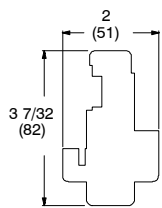
* No longer available.



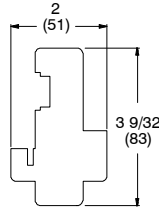
W7232 – Inactive Astragal



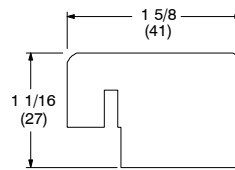
W7222 – Astragal



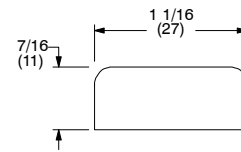
W7233 – Inactive Astragal (Multi-Point)



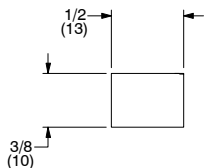
W7219 – Astragal (Multi-Point)



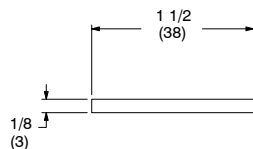
W1092 – Operator First Mull Casing



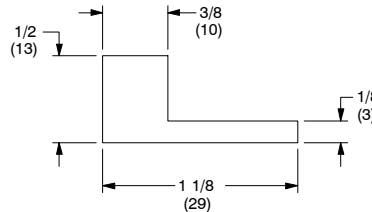
W1081 – Second Mull Casing



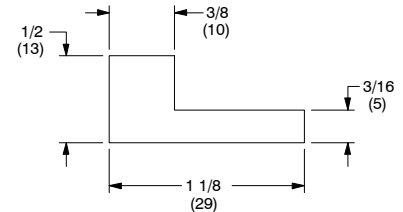
W6040* – Stationary Head Jamb, Jamb and Astragal Filler
 NA



W6220* – Stationary Head Jamb and Jamb Spacer
 NA



W7234* – Stationary Jamb Filler (1 panel)
 NA



W7235* – Stationary Jamb Filler (Multi-panel)
 NA

TO ORDER REPLACEMENT WOOD PARTS

When ordering replacement wood parts specify:

1. profile number;
2. call number or rough opening;
3. handing;
 - a. for operator first mull casing specify right or left hand (as viewed from the exterior)
 - b. for astragal specify hardware prep (if applicable)
4. length;
5. finish;
6. radius (if applicable).

OBSOLETE WEATHER STRIP

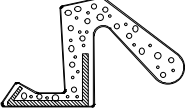
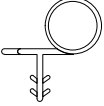
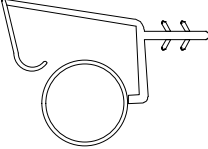


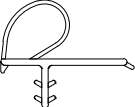

OUTSWING FRENCH DOORS

Wood Ultimate Outswing French Door 1989 – 1/17/00.

Clad Outswing French Door 1990 – 1/17/00.

When ordering replacement weather strip specify:



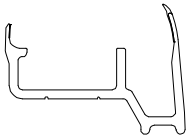
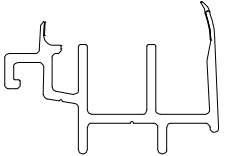
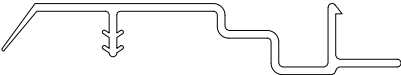

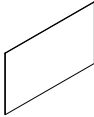
1. quantity;
2. length;
3. part number;
4. description.

ILLUSTRATION NOT TO SCALE	DESCRIPTION	LENGTH	PART NUMBER
	Foam Weather Strip, Frame V650 Color: Beige Wood doors only	144"	NA
	Bulb Weather Strip, Transom Bottom Rail V192 Color: Beige	192"	15900118
	Leaf Bulb Weather Strip, Inactive Astragal V501 Color: Beige Clad outswing doors only	98"	NA
	Bulb Weather Strip, Active Astragal V910 Color: Beige Clad Outswing doors only	Lineal Foot	15610999
	Pile Weather Strip, Sill Adhesive backed Color: Beige 13/16" x 13/32" x 1 15/16"		NA
	Offset Bulb Weather Strip, Parting Stop, Frame, Mull Casing, Transom and Astragal V796 Color: Beige	189 11/16"	15173298
	Weather Strip, Stile V020 Color: Beige	95 9/16"	11197980

OBSOLETE WEATHER STRIP**OUTSWING FRENCH DOORS***Ultimate Outswing – Pre 2012*

When ordering replacement weather strip specify:

1. quantity;
2. length;
3. part number;
4. description.

ILLUSTRATION NOT TO SCALE	DESCRIPTION	LENGTH	COLOR	PART NUMBER
	Weather Strip, Sill V776	87 11/16" 164 7/8" 164 7/8"	Beige Beige Black	11197276 11197296 11197297
	Dust Block, Astragal or Panel 1 3/8" x 1/4" x 3/8"		Gray	10500049
	Sweep, Active and Inactive Panel V2428 <i>For IZ4 UOFD post 6/30/2015</i>	70 1/2" 70 1/2"	Beige Black	11182470 11182471
	Sweep, Stationary Panel V2429 <i>For IZ4 UOFD post 6/30/2015</i>	70 1/2" 70 1/2"	Beige Black	11181970 11181971
	Weather Strip, Frame – Pre 2012 V017 lineal	164 7/8" 200"	Beige Black	11197596 11197598
	Corner Gasket Adhesive backed		Black	15600023
	Butyl Tape 3" Width	Per Roll	Black	11406302

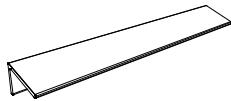
ORDERING REPLACEMENT VINYL, ALUMINUM OR FIBERGLASS PARTS FOR THE OUTSWING FRENCH DOOR

Wood Ultimate Outswing French Door 1989 – 1/17/00.

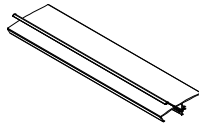
Clad Outswing French Door 1990 – 1/17/00.

	Clad	Wood
Panel Drip	V251	---
Panel Drip	V2115	V2115
Panel Cap – Beige	V360	V360
Stationary and Sidelite Leveling Block – Beige	V770*	V770*
Active Astragal	A732	---
Inactive Astragal Cladding (Multi-Point)	A733	---
Inactive Astragal Cladding (non Multi-Point)	A721	---
Ultrex Sill – Beige	F252*	F252*
Ultrex Sill, 4 9/16" Jamb (includes weep system, sill liner and Weather Strip) – Beige or Bronze	F256	F256

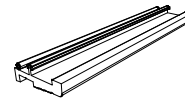
* No longer available (shaded).



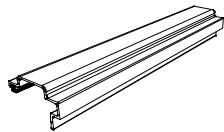
V251 – 12' 6" Panel Drip
15801099 WH,
15801299 PB,
BG – NA, BR – NA, BZ – NA



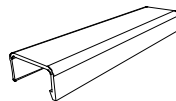
V360 – Panel Cap
Order: part # 16222999 – Beige-150"



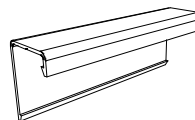
*V770 – Stationary and Sidelite Leveling Block



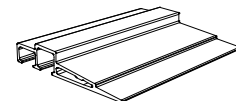
A732 – Active Astragal



A733 – Inactive Astragal Cladding (Multi-Point)



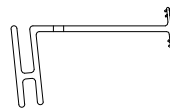
A721 – Inactive Astragal Cladding (non Multi-Point)



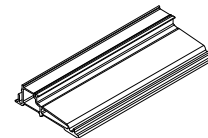
*F252 – Ultrex Sill



V2115 – Panel Drip



V027 – Sill Leveling Block (Transom) Pre-2012



F256 – Ultrex Sill, 4 9/16" Jamb Pre-2012

TO ORDER REPLACEMENT PARTS

When ordering replacement parts specify:

1. profile number;
2. size (call number or rough opening);
3. length;
4. handing;
5. finish (where applicable).

ORDERING REPLACEMENT PANELS FOR THE WOOD AND CLAD OUTSWING FRENCH DOOR

Wood Ultimate Outswing French Door 1989 – 1/17/00.

Clad Outswing French Door 1990 – 1/17/00.

To order replacement panels specify:

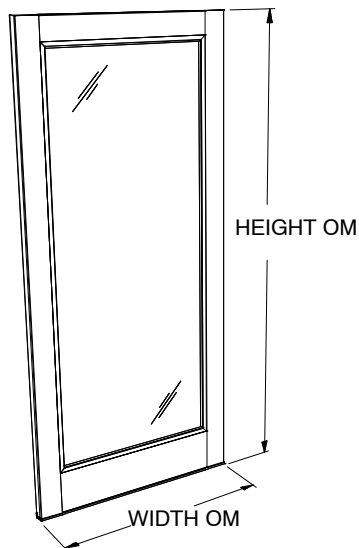
1. Wood or Clad;
2. size (call number or OM of panel);
3. active, inactive or stationary;
 - a. specify bore or no bore
4. handing;
5. glazing;
6. finish.

CLAD AND WOOD OUTSWING FRENCH DOOR (PRE 2000)

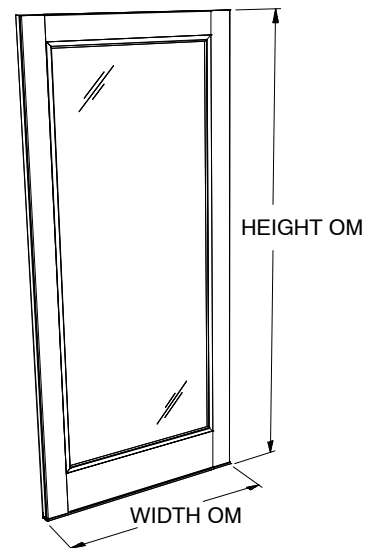
CN	Panel OSM		Panel DLO	
	Width	Height	Width	Height
2068 / 4068	24"	80"	14 1/2"	67 1/8"
2668 / 5068	30"	80"	20 1/2"	67 1/8"
2868 / 5468	32"	80"	22 1/2"	67 1/8"
3068 / 6068	36"	80"	26 1/2"	67 1/8"
2665	27 5/8"	76 5/16"	18 1/8"	63 7/16"
3065	33 5/8"	76 5/16"	24 1/8"	63 7/16"
7/0 Height		84"		67 1/8"
8/0 Height		96"		80 7/8"

Units will have:

- 4 3/4" top rail and stiles. Bottom rail height: 6/5 and 6/8 = 8 1/8"; 7/0 = 12 1/8"; and 8/0 = 10 3/8".
- 4" x 4" butt hinges. 6/5, 6/8, and 7/0 heights will have 4 hinges. 8/0 height will have 5 hinges.



Wood Ultimate Outswing Active Panel Exterior View



Clad Ultimate Outswing Active Panel Exterior View

Active panels include: sweep, route for hinges and panel cap. Clad Ultimate Outswing panels also include panel drip.

Inactive panels include: sweep, route for hinges, astragal, head and foot bolts and panel cap. Clad Ultimate Outswing panels also include panel drip.

Stationary panels include: leveling block and panel cap. Clad Ultimate Outswing panels also include panel drip.

ORDERING ENERGY PANELS FOR SINGLE GLAZED WOOD OUTSWING FRENCH DOORS
Wood Outswing French Door 1989 – 1/17/00.

If you are replacing an existing energy panel, determine the outside measurement of the existing energy panel. Find the sizes that correspond to the width and height indicated on the following chart. Energy panels are available for the single glazed Wood Ultimate Outswing French Doors. Aluminum surrounds are available in bronze or stone white.

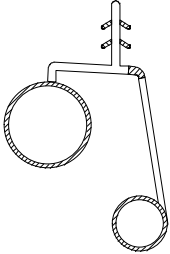
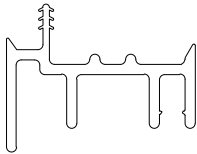
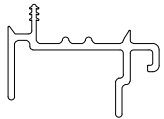
Energy panels are attached with turn buttons. Turn button styles may vary depending on current stock. You will receive the most current style in the color of your choice. (Discontinued black turn buttons will be replaced by brown.) Turn buttons can be found in the Miscellaneous Mouldings chapter of the Parts Manual

When ordering energy panels specify:

1. size; If there is no existing EP from which to obtain the OM of the panel, determine the size of the EP by using the conversion chart below. The daylight opening is the measurement of the visible glass.
2. color of surround;
3. glass type;

<p>Wood Ultimate Outswing French Door</p> <p>Wood Ultimate Outswing French Doors manufactured 1989 – 1/17/00</p> <p>Daylight Opening to OM of EP</p> <p>Daylight Width + 1" = OM Width of EP Daylight Height + 1" = OM Height of EP</p>			
WIDTH		HEIGHT	
SIZE	OM-WIDTH	SIZE	OM-HEIGHT
CN 1-6 (6-5 ht.)	9 1/2"	CN 6-5	64 1/2"
CN 2-6 (6-5 ht.)	19 1/4"		
CN 3-0 (6-5 ht.)	25 1/4"		
CN 1-4	11 13/32"	CN 6-8	68 1/8"
CN 2-0	15 1/2"	CN 7-0	68 1/8"
CN 2-6	21 1/2"	CN 8-0	81 7/8"
CN 2-8	23 1/2"		
CN 3-0	27 1/2"		

OUTSWING FRENCH DOOR / ULTIMATE OUTSWING FRENCH DOOR
DISCONTINUED WEATHER STRIP

ILLUSTRATION NOT TO SCALE	DESCRIPTION	LENGTH / COLOR		PART NUMBER
	Hinged Dual Bulb Weather Strip, Head Jamb and Jamb V193 Color: Beige Clad Outswing doors only	78" 110"	NA	
	Sweep, Active and Inactive Panel V779 <i>NOTE: Std UOFD pre 2012 IZ4 UOFD pre 6/30/2015 Replaced by V2428 for IZ4, post 6/30/15. FSO Only.</i>			CN 2/0 CN 2/6 CN 2/8 CN 3/0 CN 3/0 CN 3/6 CN 3/6
	Sweep, Stationary Panel V778 <i>NOTE: Std UOFD pre 2012 IZ4 UOFD pre 6/30/2015 Replaced by V2428 for IZ4, post 6/30/15. FSO Only.</i>	CN 3/0 CN 3/0 CN 3/6 150" 150"	Beige Black Beige Beige Black	11197330 NA 11197336 11197399 11197398