

WOOD AND CLAD ULTIMATE ARCH TOP FRENCH DOOR

Table of Contents

	PAGE
History	2
Part Identification – Wood Ultimate Inswing Arch Top French Door	4
Part Identification – Wood Ultimate Outswing Arch Top French Door	5
Part Identification – Clad Ultimate Inswing Arch Top French Door	6
Part Identification – Clad Ultimate Outswing Arch Top French Door	7
Parts – Traditional Handle – Ultimate Arch Top French Doors	8
Parts – Contemporary Handle – Ultimate Arch Top French Doors	11
Parts – Ultimate Arch Top French Doors	13
Replacement Wood Parts	20
Replacement Vinyl, Aluminum and Fiberglass Parts	21
Weather Strip	22
Panel Replacement	24
Combination Door Vinyl and Wood Replacement Parts	25
Parts for Lock Status Sensor	26
Obsolete Parts	27
Obsolete Wood Parts	35
Obsolete Vinyl, Aluminum and Fiberglass Parts	36
Obsolete Weather Strip	37
Obsolete Inswing Combination Door Parts	38
 Screens – See Door Screen Chapter	

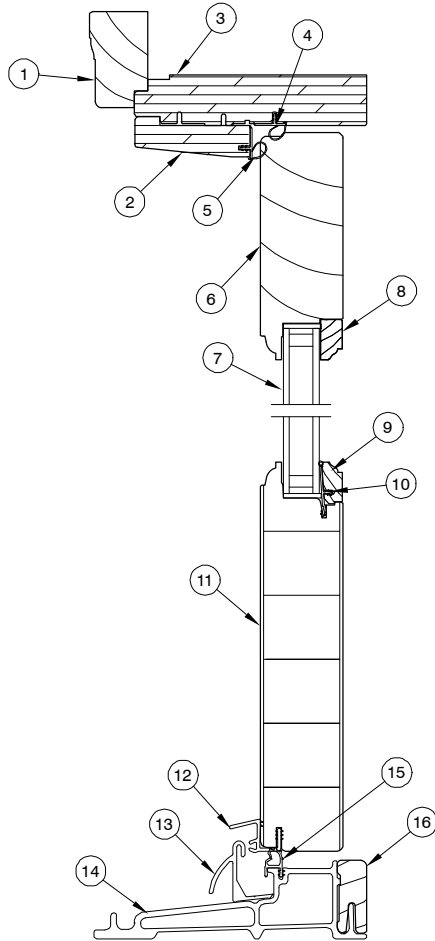
ATTENTION:

- Specification and technical data are subject to change without notice.
- Numbers listed in parentheses () are metric equivalents in millimeters rounded to the nearest whole number.

PRODUCED	UNIT TYPE	FEATURES OR CHANGES	STATUS
1991	Wood Inswing / Outswing Arch Top French Door	Unit features 3/4" interior glazed insulating glass, 4 9/16" jambs, multi-point hardware with solid brass handles and hinges, beige Lexan sill and beige external component parts. One panel doors feature 32 3/32" frame radius, two panel doors feature 63 5/8" frame radius. Units available in CN 6-8, CN 7-0 and CN 8-0 heights. All bottom rails 8 1/8". Pine interior trim and plinth blocks standard. Inswing unit features 4 9/16" or 6 9/16" one piece frame (extended to the exterior).	Present
Late 1991		Exterior factory finish available.	1996
1991	Wood Inswing Arch Top French Door	Combination introduced featuring interchangeable screen and storm inserts and complete brass hardware.	2000
1992	Wood Inswing / Outswing Arch Top French Door	Simulated divided lite option introduced.	Present
1993	Wood Arch Top French Door	Optional oak interior trim and plinth blocks introduced.	Present
1994	Arch Top French Door	Beige Lexan sill changed to beige composite sill.	2000
2000	Arch Top French Door	9-25-00 Redesign to match current rectangle Inswing and Outswing door designs.	Present
2000	Wood Inswing Arch Top French Door	Combination redesign.	2004
2002	Wood Inswing Arch Top French Door	8/0 height decreases by 2 1/2 inches.	Present
2003	Wood Inswing / Outswing Arch Top French Door	3/31/03 Satin Taupe (TP) hardware replaces Brass as standard hardware. Standard door now includes hardware (no lock, no bore now an option)	Present
2003	Wood Inswing / Outswing Arch Top French Door	3/31/03 Strikes for Satin Taupe, Brushed Chrome, Polished Chrome and White are Stainless Steel.	Present
2003	Clad Arch Top	7/03 Clad Arch Top introduced. Change in Rough Opening radius for one panel doors to 40 1/2" and for two panel doors to 72 1/2".	Present
2003	Clad Arch Top	Added radius SDL.	Present
2004	Wood/ Clad Arch Top French Door	1/04 Added Oiled Rubbed Bronze and Satin Chrome to available hardware finishes.	Present
2004	Wood / Clad Arch Top French Door	4/12/04 Satin Nickel hardware finish introduced.	Present
2004	Wood / Clad Arch Top French Door	Polished chrome finish hardware is retired.	Present
2005	Wood / Clad Arch Top French Door	Arch Top Doors become Ultimate Arch Top Doors. Inswing sills upgraded for water infiltration introduced optional bronze ultrex sill with black weatherstrip.	Present
2005	Wood / Clad Arch Top French Door	6/15/05 Changed jamb leaf on adjustable hinge to closed knuckle design.	Present
2005	Wood / Clad Arch Top French Door	6/27/05 Introduced Brass PVD and Satin Nickel PVD finishes to French door handles, adjustable hinges, and other miscellaneous parts.	Present
2007	Wood / Clad Arch Top French Door	2/20/07 Introduced raised and flat panels as a standard option for Marvin French Doors and Commercial Doors. Introduced new Ultimate Swinging Screen along with an optional Storm Plus Insert.	Present
2009	All	3/23/2009 Added LoE ³ -366™ as a standard option for all products. Added Cedro Macho as a standard option for all clad products.	Present
2011	Clad Arch Top	04/25/2011 Added LoE-180™ as a standard option for all products. White painted interior finish option introduced for all products.	Present

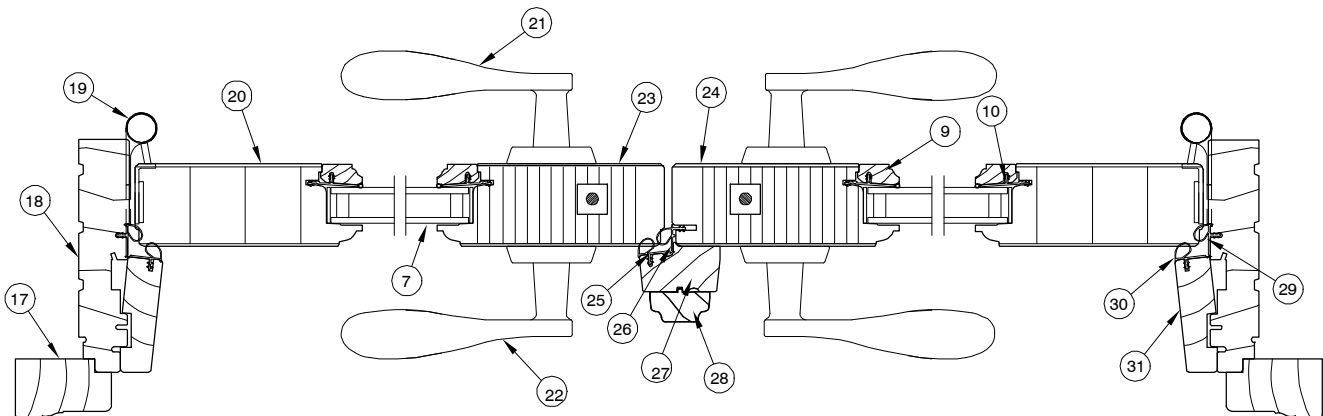
PRODUCED	UNIT TYPE	FEATURES OR CHANGES	STATUS
2012	Wood/Clad Inswing/Outswing Arch Top French Door	7/30/2012 Stave Core added to our description for current finger joint/edge glue construction of door panels. Updated adjustable hinge. 10/29/2012 Interior Square Sticking/Glazing Bead option introduced. 12/17/2012 Introduced Clear Interior Finish option on all products.	Present
2013	Wood/Clad Inswing/Outswing Arch Top French Door	4/29/2013 – Introduced interior stain options. Stain colors are Wheat, Honey, Leather, Hazelnut, Cabernet and Espresso. 12/16/2013 – Added SN PVD Butt Hinge option.	Present
2014	Wood/Clad Inswing/Outswing Arch Top French Door	2/24/2014 – Introduced two Pearlescent clad colors – Bright Silver and Copper. Discontinued two clad colors – Sherwood Green and Cobalt Blue. Removed screen information and added new chapter for screen to manual.	Present
2014	Wood/Clad Inswing/Outswing Arch Top French Door	10/27/2014 – Introduced Ogee as the new default for interior profiles.	Present
2016	All	06/27/2016 Introduced Matte Black as a standard hardware color 10/31/2016 Introduced 9–0 Call No heights 10/31/2016 Obsolescence of the wood species Cedro Macho for all products.	Present
2017	Clad Inswing/Outswing Arch Top French Door	12/18/2017 Added availability of Lock Status Sensor.	Present

**WOOD ULTIMATE INSWING ARCH TOP FRENCH DOOR
 XX L or R**



**Head Jamb
 and Sill**

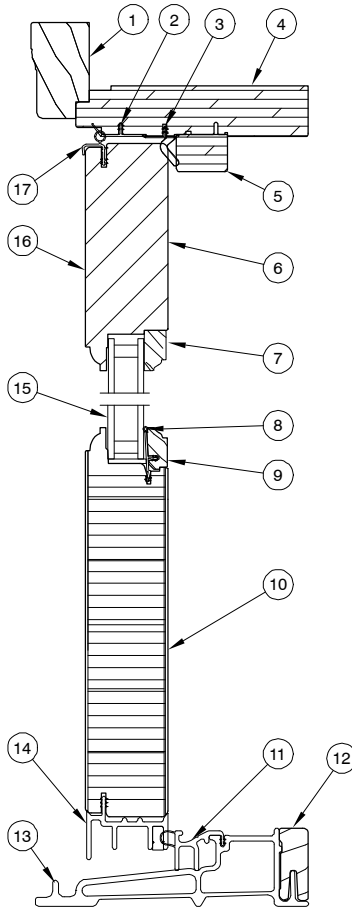
1. Head Jamb Brick Mould Casing
2. Head Jamb Parting Stop
3. Head Jamb
4. Head Jamb Weather Strip
5. Head Jamb Parting Stop Weather Strip
6. Top Rail
7. Insulated Glass
8. Top Rail Glazing Bead
9. Glazing Bead Cap
10. Vinyl Glazing Bead
11. Bottom Rail
12. Panel Drip
13. Hydro Optimizer
14. Sill
15. Sill Weather strip
16. Sill Liner
17. Side Jamb Brick Mould Casing
18. Side Jamb
19. Adjustable Hinge
20. Stile
21. Interior Handle Assembly
22. Exterior Handle Assembly
23. Active Panel Locking Stile
24. Inactive Panel Locking Stile
25. Astragal Weather Strip
26. Stile Weather Strip
27. Astragal
28. Astragal Cover
29. Side Jamb Weather Strip
30. Side Jamb Parting Stop Weather Strip
31. Side Jamb Parting Stop



Jamb - XX L

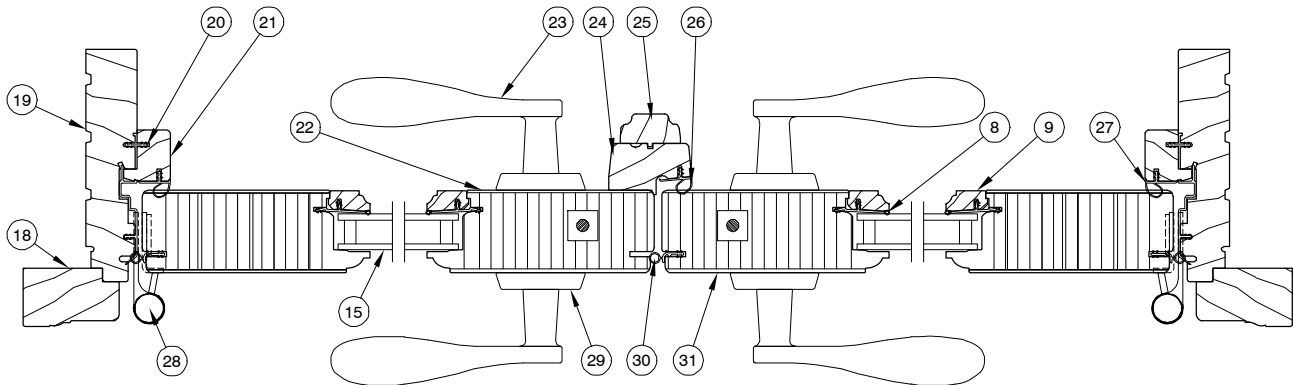
NOTE: Not to scale; specifications subject to change without notice.

**WOOD ULTIMATE OUTSWING ARCH TOP FRENCH DOOR
 XX L or R**



1. Head Jamb Brick Mould Casing
2. Frame Weather Strip
3. Head Jamb Stop Weather Strip
4. Head Jamb
5. Head Jamb Stop
6. Top Rail
7. Top Rail Glazing Bead
8. Vinyl Glazing Bead
9. Glazing Bead Cap
10. Bottom Rail
11. Sill Weather Strip
12. Sill Liner
13. Sill
14. Sweep
15. Insulating Glass
16. Top Rail
17. Panel Cover Weather Strip
18. Side Jamb Brick Mould Casing
19. Side Jamb
20. Connecting Barb
21. Side Jamb Parting Stop
22. Inactive Panel Locking Stile
23. Interior Handle Assembly
24. Astragal Base
25. Astragal Cover
26. Astragal Weather Strip
27. Side Jamb parting Stop Weather Strip
28. Adjustable Hinge
29. Exterior Handle Assembly
30. Stile Weather Strip
31. Active Panel Locking Stile

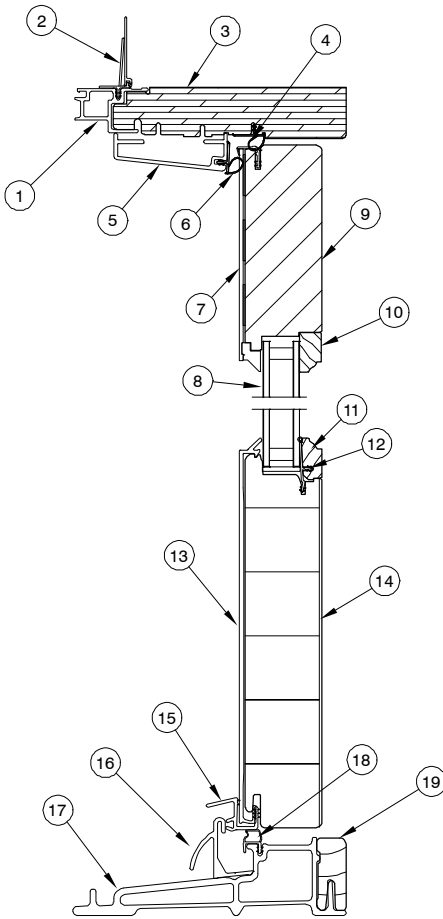
**Head Jamb
 and Sill**



Jamb – XX L

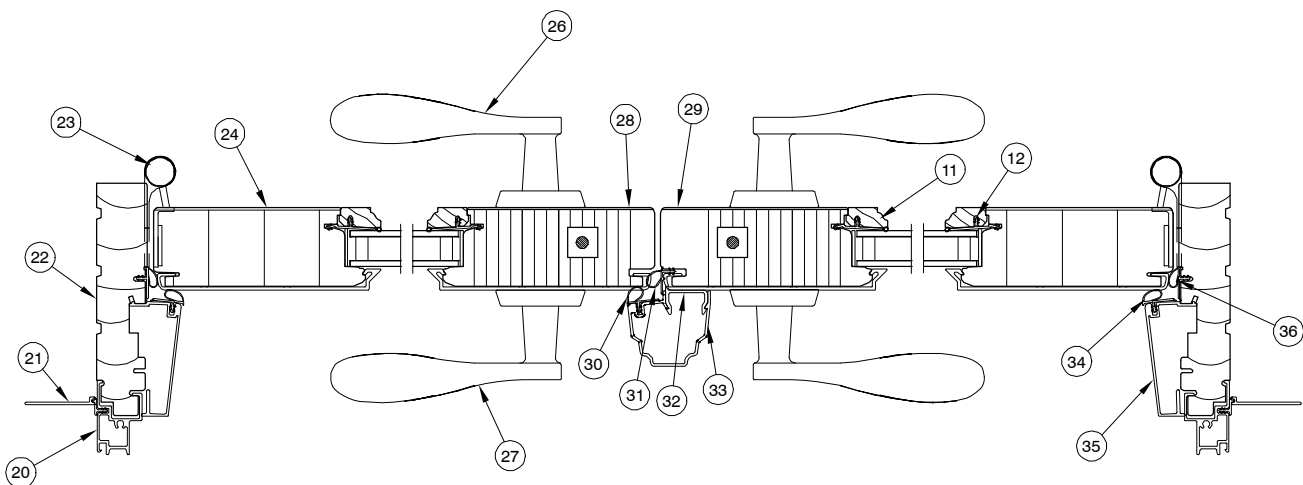
NOTE: Not to scale; specifications subject to change without notice.

**CLAD ULTIMATE INSWING ARCH TOP FRENCH DOOR
 XX L or R**



1. Head Jamb Cladding
2. Head Jamb Nailing Fin/Drip Cap
3. Head Jamb
4. Head Jamb Weather Strip
5. Head Jamb Stop
6. Head Jamb Stop Weather Strip
7. Top Rail Cladding
8. Insulated Glass
9. Top Rail
10. Top Rail Glazing Bead
11. Glazing Bead Cap
12. Vinyl Glazing Bead
13. Bottom Rail Cladding
14. Bottom Rail
15. Panel Drip
16. Hydro Optimizer
17. Sill
18. Sill Weather Strip
19. Sill Liner

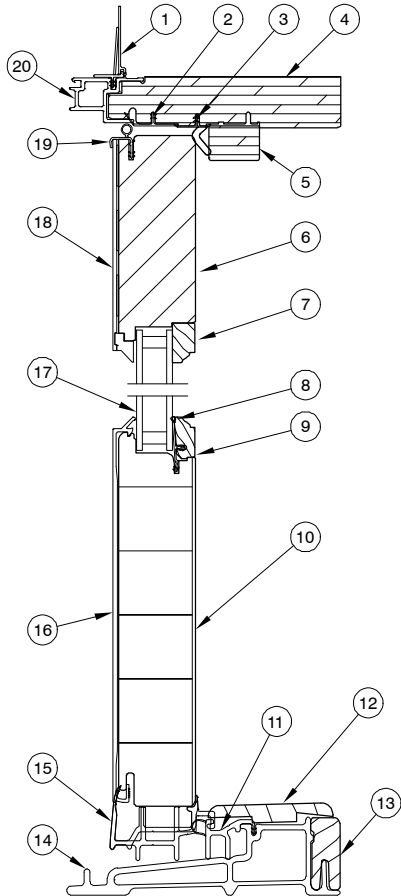
**Head Jamb
 and Sill**



Jamb – XX L

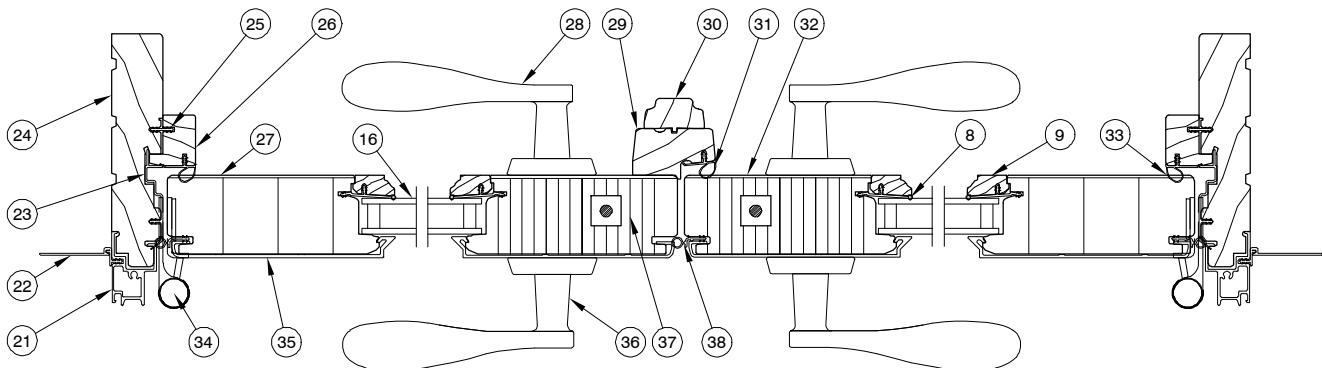
NOTE: Not to scale; specifications subject to change without notice.

**CLAD ULTIMATE OUTSWING ARCH TOP FRENCH DOOR
 XX L or R**



1. Head Jamb Nailing Fin/Drip Cap
2. Frame Weather Strip
3. Head Jamb Weather Strip
4. Jamb
5. Head Jamb Parting Stop
6. Top Rail
7. Top Rail Glazing Bead
8. Vinyl Glazing Bead
9. Glazing Bead Cap
10. Bottom Rail
11. Sill Weather Strip
12. Sill Cover
13. Sill Liner
14. Sill
15. Sweep
16. Bottom Rail Cladding
17. Insulating Glass
18. Top Rail Cladding
19. Panel Cover Weatherstrip
20. Head Jamb Cladding
21. Side Jamb Cladding
22. Side Jamb Nailing Fin
23. Frame Weatherstrip
24. Jamb
25. Connecting Barb
26. Side Jamb Parting Stop
27. Stile
28. Interior Handle Assembly
29. Astragal Base
30. Astragal Cover
31. Astragal Weatherstrip
32. Active Panel Locking Stile
33. Jamb Stop Weatherstrip
34. Adjustable Hinge
35. Stile Cladding
36. Exterior Handle Assembly
37. Inactive Panel Locking Stile
38. Stile Weatherstrip

**Head Jamb
 and Sill**



Jamb - XX L



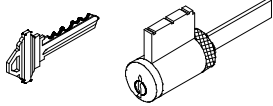
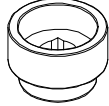
NOTE: Not to scale; specifications subject to change without notice.

When ordering replacement Ultimate Arch Top French Door parts specify:

1. type of unit; part number; description

ILLUSTRATIONS (not to scale)		
<p>Handle Assembly, Active Panel Mortise lock and Multi-point lock systems (Schlage "C" keyway) Includes: 1 - Interior lever (A) with 00142006 spindle, escutcheon plate and hardware 1 - Exterior lever (B) with escutcheon plate and hardware 1 - Thumb turn (C) with hardware 1 - Keyed cylinder (D) with housing and hardware 1 - Exterior escutcheon plate gasket (E) 1 - Exterior escutcheon plate (F) 1 - Two piece spindle (G) 2 - #10-32 x 2 1/8" Phillips ovalhead machine screws (H) 1 - Interior escutcheon plate (I) 1 - Thumb turn washer (J) 1 - Thumb turn push nut (K) 2 - Keys</p>	<p>Satin Taupe 10830304 Antique Brass 10830306 White 10830310 Satin Chrome 10830302 Oil Rubbed Bronze 10148111 Oil Rubbed Bronze PVD 10830300 Brass PVD 10830324 Satin Nickel PVD 10830421 Dark Bronze 10830330 Polished Chrome 10830308 Matte Black 10830450</p>	
<p>Handle Assembly, Inactive/Dummy Includes: 1 - Interior lever (A) with 00142006 spindle, escutcheon plate and hardware 1 - Exterior lever (B) with escutcheon plate and hardware 1 - Exterior escutcheon plate gasket (C) 1 - Exterior escutcheon plate (D) 1 - Two piece spindle (E) 2 - #10-32 x 2 1/8" Phillips ovalhead machine screws (F) 1 - Interior escutcheon plate (G)</p>	<p>Satin Taupe 10830318 Antique Brass 10830312 White 10830316 Satin Chrome 10830320 Oil Rubbed Bronze 10148154 Oil Rubbed Bronze PVD 10830322 Brass PVD 10830326 Satin Nickel PVD 10830422 Dark Bronze 10830328 Polished Chrome 10830314 Matte Black 10148157</p>	
<p>Thumb Turn (C) NOTE: For each thumb turn, order one thumb turn washer -00143045 (J) and one thumb turn push nut 00143010 (K).</p>	<p>Satin Taupe 00142061 Antique Brass 00142055 White 00142058 Oil Rubbed Bronze 00142062 Oil Rubbed Bronze PVD 10148428 Brass PVD 00142054 Satin Nickel PVD 00142063 Satin Chrome 00142064 Dark Bronze 10148426 Matte Black 10148480</p>	

PARTS – TRADITIONAL HANDLE

ILLUSTRATION NOT TO SCALE	DESCRIPTION	LENGTH/COLOR	PART NO.
	<p>Lug seals 9/25/00 – Present</p>		00142046
	<p>#10–32 x 2 1/8" Phillips ovalhead machine screw 9/25/00 – Present</p>	<p>Satin Taupe Antique Brass White Satin Chrome Oil Rubbed Bronze ORBZ PVD Brass PVD Satin Nickel PVD Dark Bronze Matte Black</p>	<p>11800616 00143038 00143036 10840031 10840032 11800160 11800615 NA 11800654 11800181</p>
	<p>Key Cylinder, Lock 9/25/00 – Present (Schlage "C" keyway) For service replacement only. <i>NOTE: For Keyed Alike orders, use program C87P2.</i></p> <p><i>BS, ORBZ PVD, TP, WH, AB=Brass Face All other Marvin finishes=Chrome Face</i></p>	<p>Brass Face Chrome Face</p>	<p>10830211 10830208</p>
	<p>3/4" Handle Extension NOTE: Requires 3/4" spindle extension.</p> <p>3/8" Handle Extension NOTE: Requires 3/8" spindle extension.</p>	<p>Satin Taupe White Bright Brass Antique Brass Oil Rubbed Bronze Oil Rubbed Bronze PVD Satin Chrome Satin Nickel Polished Chrome Dark Bronze Matte Black</p> <p>Satin Taupe White Bright Brass Antique Brass Oil Rubbed Bronze Oil Rubbed Bronze PVD Satin Chrome Satin Nickel Polished Chrome Dark Bronze Matte Black</p>	<p>10830048 10833063 10833058 10833057 10833038 10833059 10833056 10148422 10833062 10833054 10833055</p> <p>10833049 10833055 N/A 10833046 10833044 10833048 10833045 10833038 N/A 10833042 10833043</p>

* Stainless Steel – 11800645, Dark Bronze – 11800652, PVD Brass – 11800536

NOTE: Dark Bronze screws are used with Antique Brass and Oil Rubbed Bronze PVD

PARTS – TRADITIONAL HANDLE

ILLUSTRATION NOT TO SCALE	DESCRIPTION	LENGTH/COLOR	PART NO.
	<p>Spindle Kit (Truth & Ashland) Includes: 1 – 2 piece. spindle, 4 3/8” 2 – Set screws</p>	<p>Used with TP, WH, DK BZ, MBK, SC, AB, ORBZ, ORBZ PVD</p>	<p>02100942</p>
	<p>Spindle Kit (HOPPE) Includes: 1 – 2 piece. spindle, 4 3/4” 2 – Set screws</p>	<p>Used with SN PVD BS PVD</p>	<p>10148414</p>
	<p>Lever Bushing, Swinging Handle Set – Traditional</p>	<p>Clear Gray Gold Natural Black</p>	<p>02062201 10148448 10148447 02062202 10148020</p>
	<p>3/4” Spindle Extension 3/8” Spindle Extension</p>	<p>5 13/16” 5 1/16”</p>	<p>00142051 18900393</p>

* Stainless Steel – 11800645, Dark Bronze – 11800652, PVD Brass – 11800536

NOTE: Dark Bronze screws are used with Antique Brass and Oil Rubbed Bronze PVD

When ordering replacement parts specify:

1. type of unit;
2. part number;
3. description.

ILLUSTRATIONS (not to scale)		
<p>Active Panel</p> <p>Exterior Interior</p>	<p>Inactive/Dummy</p> <p>Interior Exterior</p>	
<p>Handle Assembly, Active Panel Mortise lock and Multi-point lock systems (Schlage "C" keyway) Includes: 1 – Interior lever (A) with 10148414 spindle, escutcheon plate and hardware 1 – Exterior lever (B) with escutcheon plate and hardware 1 – Thumb turn (C) with hardware 1 – Keyed cylinder (D) with housing and hardware 1 – Exterior escutcheon plate gasket (E) 1 – Exterior escutcheon plate (F) 1 – Two piece spindle (G) 2 – M5 x 55mm Phillips ovalhead machine screws (H) 1 – Interior escutcheon plate (I) 1 – Thumb turn washer (J) 1 – Thumb turn push nut (K) 2 – Keys</p>	<p>ORBZ PVD SN PVD DK BZ MBK</p>	<p>11102151 11102152 11102156 11102192</p>
<p>Handle Assembly, Inactive/Dummy Includes: 1 – Interior lever (A) with 00142006 spindle, escutcheon plate and hardware 1 – Exterior lever (B) with escutcheon plate and hardware 1 – Exterior escutcheon plate gasket (C) 1 – Exterior escutcheon plate (D) 1 – Two piece spindle (E) 2 – M5 x 55mm Phillips ovalhead machine screws (F) 1 – Interior escutcheon plate (G)</p>	<p>ORBZ PVD SN PVD DK BZ MBK</p>	<p>11102154 11102155 11102157 11102193</p>
<p>Thumb Turn (C)</p> <p>NOTE: For each thumb turn, order one thumb turn washer –10148423(J) and one thumb turn push nut 10148424(K).</p>	<p>ORBZ PVD SN PVD DK BZ</p>	<p>10148428 10148427 10148426</p>

PARTS – CONTEMPORARY HANDLE


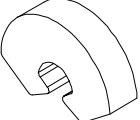


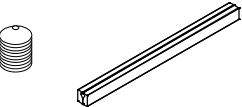
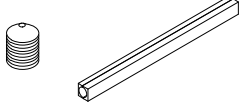

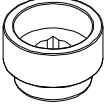

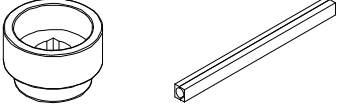
ILLUSTRATION NOT TO SCALE	DESCRIPTION	OPER./COLOR	PART NO.
	Gasket Post		10148404
	Gasket – Top Backplate		10148405
	M5 x 55mm Phillips ovalhead machine screw	TP ORBZ PVD SN PVD DK BZ MBK	10148400 10148402 10148403 10148401 10148440
	Key Cylinder, Lock (Schlage “C” keyway) For service replacement only. <i>NOTE: For Keyed Alike orders, use program C87P2.</i> <i>BS, ORBZ PVD, TP, WH, AB=Brass Face</i> <i>All other Marvin finishes=Chrome Face</i>	Brass Face Chrome Face	10830211 10830208
	Spindle Kit (Truth & Ashland) <i>Includes:</i> 1 – 2 piece. spindle, 4 3/8” 2 – Set screws	Used with TP, WH, DK BZ, MBK, SC, AB, ORBZ, ORBZ PVD	02100942
	Spindle Kit (HOPPE) <i>Includes:</i> 1 – 2 piece. spindle, 4 3/4” 2 – Set screws	Used with SN PVD BS PVD	10148414
	Lever Bushing, Swinging Handle Set – Contemporary	Gray Natural Black	10148448 02062202 10148020
	3/4" Handle Extension Requires 3/4" Spindle Extension	TP ORBZ PVD SN PVD DK BZ	10148419 10148421 10148422 10148420
	3/4" Spindle Extension (HOPPE)		10148415
	1 3/4" Swinging Handle Set Kit – Interior Shades <i>Includes:</i> 1 – 3/4" extension handle 1 – Spindle, lever handle, 2 pc. assembly 1 – Installation instruction	TP ORBZ PVD SN PVD DK BZ	21448100 21448102 21448103 21448101

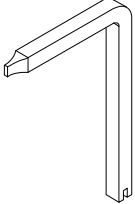
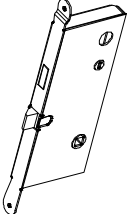
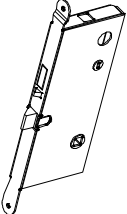
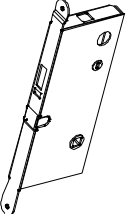
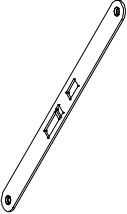
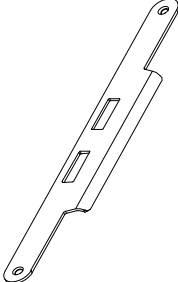


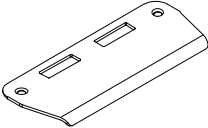
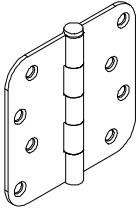
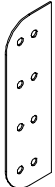
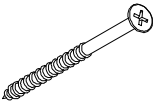
ILLUSTRATION NOT TO SCALE	DESCRIPTION	OPER./COLOR	PART NO.
	<p>Construction Handle</p>		<p>10830451</p>
	<p>Mortise Lock, Active Single Point (latch and dead bolt only) <i>9/25/00 – Present (Amerock)</i></p>		<p>05700129</p>
	<p>Mortise Lock, Active Multi-Point Lock (latch, dead bolt and head/foot shoot bolts) <i>9/25/00 – Present (Amerock)</i></p>		<p>05700130</p>
	<p>Mortise Lock, Inactive Panel Multi-Point Lock (head/foot shoot bolts) <i>9/25/00 – Present (Amerock)</i></p>		<p>05700131</p>
	<p>Cover Plate, Active Mortise Lock or Multi-Point Lock <i>9/25/00– Present (Amerock)</i> Includes: 1 – Cover plate 2 – #8x1” Phillips flathead wood screws</p>	<p>Stainless Steel Antique Brass ORBZ PVD Brass PVD</p>	<p>05700306 05700307 05700308 10148179</p>
	<p>Strike Plate, Panel – Mortise Lock or Multi-Point Lock <i>UOAF – std. on 2-panel operator</i> <i>1/17/00 – Present (Amerock)</i> Includes: 1 – Jamb strike plate 2 – #8x1” Phillips flathead wood screws</p>	<p>Stainless Steel Antique Brass ORBZ PVD Brass PVD</p>	<p>05700312 05700313 05700314 10148183</p>

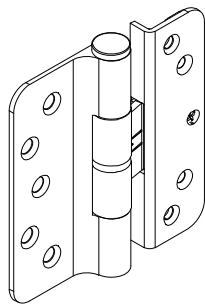
ILLUSTRATION NOT TO SCALE	DESCRIPTION	OPER./COLOR	PART NO.
	<p>Strike Plate, Jamb–Mortise Lock or Multi–Point Lock UIAF – std. on 1 panel operator 9/25/00 – Present (Amerock) Includes: 1 – Jamb strike plate 2 – #8x1” Phillips flathead wood screws*</p>	Stainless Steel Antique Brass ORBZ PVD Brass PVD	05700300 05700301 05700302 10148177
	<p>Strike Plate, Inactive Panel–Mortise Lock or Multi–Point Lock UIAF – std. on 2 panel operator 9/25/00 – Present (Amerock) Includes: 1 – Jamb strike plate 2 – #8x1” Phillips flathead wood screws*</p>	Stainless Steel Antique Brass ORBZ PVD Brass PVD	05700303 05700304 05700305 10148178
	<p>Strike Plate, Jamb – Mortise Lock or Multi–Point Lock UOAF – std. on 1 panel operator 1/17/00 – Present (Amerock) Includes: 1 – Jamb strike plate 2 – #8x1” Phillips flathead wood screws*</p>	Stainless Steel Antique Brass ORBZ PVD Brass PVD	05700309 05700310 05700311 10148182
	<p>4” Butt Hinge NRP = Non Removable Pin Includes: 1 – 4” hinge 7 – #9 x 1” Phillips flathead wood screws (11213824) 1 – #10 x 2 1/2” Phillips flathead wood screws (frame) (11800679)</p>	BS SN PVD SS	02101140 02100599 11809005
	<p>4” Butt Hinge Shim</p>		10500222
	<p>Long Hinge Screw Package 9/25/00 – Present Includes: 4 –#10 X 2 1/2” Screws* 1 – 5/32” Allen wrench Note: Order Dark Bronze screw package for Dark Bronze, Antique Brass and Oil Rubbed Bronze Hinges. Order Stainless Steel screw package for Silver Frost, Satin Chrome and Satin Nickel PVD Hinges .</p>	Satin Taupe Gold Tone Dark Bronze White Stainless Steel Brass PVD Matte Black	11800653 11800632 11800644 11800637 11800639 10148185 11800696

* Stainless Steel – 11800645, Dark Bronze – 11800652, PVD Brass – 11800536

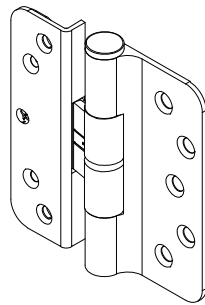
NOTE: Dark Bronze screws are used with Antique Brass and Oil Rubbed Bronze PVD

ILLUSTRATION
NOT TO SCALE

Note: Always view units from the exterior for handing. H = Hinge location.

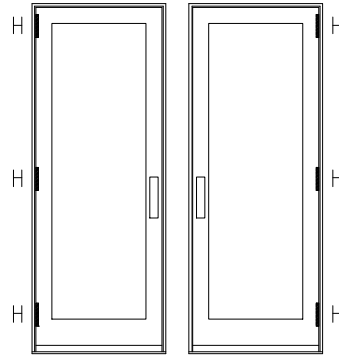


LH Hinge

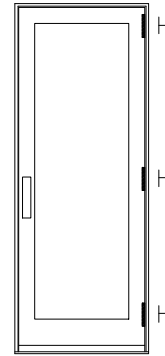


RH Hinge

This panel uses the right hand hinge



X-R



X-L

This panel uses the left hand hinge

DESCRIPTION		HINGE COLOR	LEFT PART NO.	RIGHT PART NO.
Hinge Kit, Adjustable Includes: 1 – Adjustable hinge 1 – #10x2 1/2"Phillips flathead wood screws (jamb) 5 – #10x3/4"Phillips flathead wood screws (jamb, stationary stile) 4 – #8x1 1/2"Phillips flathead wood screws (panel)		TP GT SF DKBZ AB WH SC ORBZ ORBZ PVD BS PVD SN PVD PC MBK	02101216 02101213 02101218 02101217 02101210 02101214 02101212 02101219 02101211 02101215 02101220 02101234 02101236	02101227 02101224 02101229 02101228 02101221 02101225 02101223 02101230 02101222 02101226 02101231 02101235 02101237
SCREW DESCRIPTION	SCREW COLOR/PART NO.	MATCHING HINGE COLOR		
#8x1 1/2"Phillips flathead wood screws (panel). Quantity of four needed per hinge.	TP 11865177	TP		
	GT 11865172	GT		
	WH 11865173	WH		
	DKBZ 02058013	AB, ORBZ PVD, DKBZ, ORBZ		
	BS PVD 11865176	BS PVD		
	SS 11865175	SC, SF, SN PVD, PC		
	MBK 11865178	MBK		
#10x 3/4"Phillips flathead wood screws (jamb) (stationary stile). Quantity of five needed per hinge.	TP 11800674	TP		
	GT 11800670	GT		
	WH 11800671	WH		
	DKBZ 11800669	AB, ORBZ PVD, DKBZ, ORBZ		
	BS PVD 11800673	BS PVD		
	CHROME 11800672	SC, SF, SN PVD, PC		
	MBK 11800677	MBK		
#10x2 1/2"Phillips flathead wood screws (jamb). Quantity of one needed per hinge.	TP 11800683	TP		
	GT 11800681	GT		
	WH 11800682	WH		
	DKBZ 11800680	AB, ORBZ PVD, DKBZ, ORBZ		
	BS PVD 11800679	BS PVD		
	SS 11800684	SC, SF, SN PVD, PC		
	MBK 11800693	MBK		

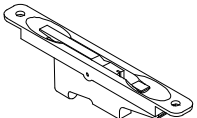
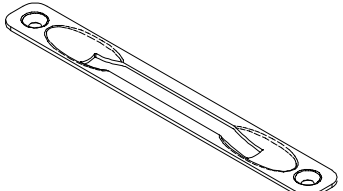
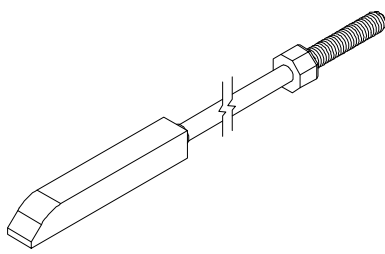
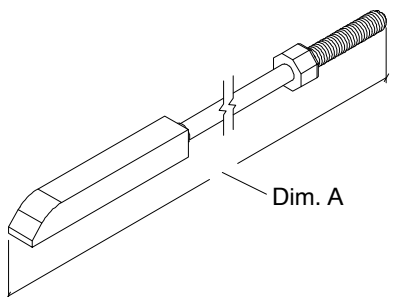
ILLUSTRATION NOT TO SCALE	DESCRIPTION	OPER./COLOR	PART NO.														
	Head or Foot Flush Bolt – Inactive Panel	Black	11101780														
	Cover Plate for Flush Bolt <i>Includes:</i> 1 – Cover plate 2 – #8x1" SS screw (11800645)	Aluminum	11860402														
	Inactive Panel Locking Rod Assembly, Top or Bottom Flush Bolt <i>9/25/00 – Present</i> <i>Includes:</i> 1 – Locking rod with end bolt NOTE: For 8-0 ht order top locking rod 05700185. <table border="0"> <thead> <tr> <th>Height</th> <th>Top Locking Rod Length</th> </tr> </thead> <tbody> <tr> <td>CN 6-8 ht</td> <td>11"</td> </tr> <tr> <td>CN 7-0 ht</td> <td>11"</td> </tr> <tr> <td>CN 8-0 ht</td> <td>27"</td> </tr> <tr> <td>CN 9-0 ht</td> <td>34 1/4"</td> </tr> <tr> <th>Height</th> <th>Bottom Locking Rod Length</th> </tr> <tr> <td>All heights</td> <td>11 1/2"</td> </tr> </tbody> </table>	Height	Top Locking Rod Length	CN 6-8 ht	11"	CN 7-0 ht	11"	CN 8-0 ht	27"	CN 9-0 ht	34 1/4"	Height	Bottom Locking Rod Length	All heights	11 1/2"	Stainless Steel	05700180 05700180 05700185 05700170
Height	Top Locking Rod Length																
CN 6-8 ht	11"																
CN 7-0 ht	11"																
CN 8-0 ht	27"																
CN 9-0 ht	34 1/4"																
Height	Bottom Locking Rod Length																
All heights	11 1/2"																
	Locking Rod Assembly, Top for Multi-Point <i>Active Panels – w/multi-point</i> 3/02 – Present (Amerock) 8-0 Height see History 5/10/90 – Present (Amerock) 6-8 & 7-0 Height Solid stainless steel rod with 1/4" – 20 threads NOTE: For special heights give dimension A.	Stainless Steel	05700176 05700177 05700179 05700191														

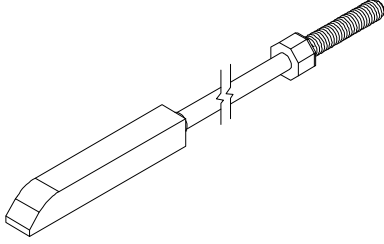
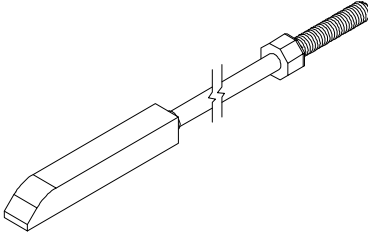
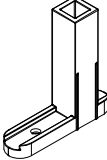
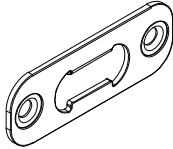
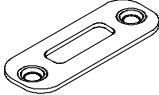

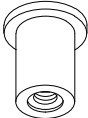
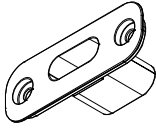
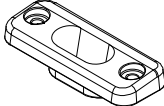

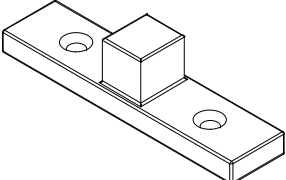
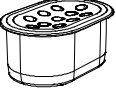
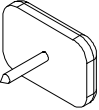

ILLUSTRATION NOT TO SCALE	DESCRIPTION	OPER./COLOR	PART NO.										
	<p>Locking Rod Assembly, Bottom for Multi-Point Lock UIAF Active Panels - w/multi-point 9/25/00 - Present (Amerock) Solid stainless steel rod with 1/4" - 20 threads</p> <table border="0"> <tr> <td>Height</td> <td>Bottom Locking Rod Length</td> </tr> <tr> <td>CN 6-8 ht</td> <td>34 9/32"</td> </tr> <tr> <td>CN 7-0 ht</td> <td></td> </tr> <tr> <td>CN 8-0 ht</td> <td></td> </tr> <tr> <td>CN 9-0 ht</td> <td></td> </tr> </table>	Height	Bottom Locking Rod Length	CN 6-8 ht	34 9/32"	CN 7-0 ht		CN 8-0 ht		CN 9-0 ht		Stainless Steel	05700170
Height	Bottom Locking Rod Length												
CN 6-8 ht	34 9/32"												
CN 7-0 ht													
CN 8-0 ht													
CN 9-0 ht													
	<p>Locking Rod Assembly, Bottom for Multi-Point Lock UOAF Active Panels - w/multi-point 9/25/00- Present Solid stainless steel rod with 1/4" - 20 threads</p> <table border="0"> <tr> <td>Height</td> <td>Bottom Locking Rod Length</td> </tr> <tr> <td>CN 6-8 ht</td> <td>34 3/4"</td> </tr> <tr> <td>CN 7-0 ht</td> <td></td> </tr> <tr> <td>CN 8-0 ht</td> <td></td> </tr> <tr> <td>CN 9-0 ht</td> <td></td> </tr> </table>	Height	Bottom Locking Rod Length	CN 6-8 ht	34 3/4"	CN 7-0 ht		CN 8-0 ht		CN 9-0 ht		Stainless Steel	10815179
Height	Bottom Locking Rod Length												
CN 6-8 ht	34 3/4"												
CN 7-0 ht													
CN 8-0 ht													
CN 9-0 ht													
	<p>Shoot Bolt Guide 9/25/00 - Present Active Panels - w/Multi-Point Inactive Panels - All 1 - Shoot bolt guide (10815186) 1 - #8x1 1/2" Phillips panhead wood screw (11800766)</p>		10815199										

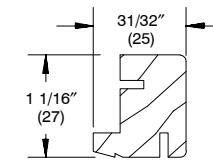
ILLUSTRATION NOT TO SCALE	DESCRIPTION	OPER./COLOR	PART NO.
	<p>Strike Plate, Head Jamb/Sill UIAF 9/25/00 – Present Includes: 1 – Strike plate Uses: 2– #8 x 1/2 " machine screws</p>	SS	10815201
	<p>Strike Plate, Sill UIAF Includes: 1 – Strike plate Uses: 2– #8 x 1/2 " machine screws</p>	SS	NA (use PN 10815201)
	<p>Fastener, Strike Plate, Sill and Head Jamb UIAF #8 x 1/2 " machine screws</p>	SS	11800847
	<p>Well-Nut Threaded Insert UIAF 9/25/00 – Present</p>	BK	10830008
	<p>Strike Plate, Head Jamb UOAF 9/25/00 – Present Includes: 1 – Strike plate 2 – #8 x 1" Phillips trusshead screws (head jamb) 2– #8 x 3" trusshead stainless screws (head jamb) (11800832))</p>	BG BZ	05700315 05700316
	<p>Strike, Sill UOAF 9/25/00 – Present Includes: 1 – Strike plate 2 – #8 x 5/8" Phillips panhead stainless steel machine screws (sill) (11800726) 2 – Well-nut threaded insert (sill) 10830008</p>	BG BZ	18900365 18900368

PARTS

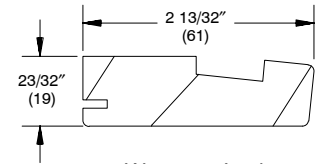
ILLUSTRATION NOT TO SCALE	DESCRIPTION	OPER./COLOR	PART NO.
	<p>Installation Screw Package; Strike Plate(s) at head jamb, sill, or locking jamb <i>9/25/00 - Present</i> #8 x 2 1/2" Flathead wood screw</p> <p>Package of 2 Package of 2 Package of 2</p>	<p>Stainless Steel Solid Brass Antique Brass</p>	<p>11882349 11882343 11882347</p>
	<p>Sill Bolt, Stationary Panel <i>9/25/00 - Present</i> Includes: 2 - #8 x 3" Phillips flathead wood screws (11800830)</p>	<p>Zinc Die Cast</p>	<p>11101856</p>
	<p>Drain Plug, Sill UIAF <i>9/25/00 - Present</i></p>	<p>BG BZ</p>	<p>10500253 10500249</p>
	<p>Head Jamb Spacer Tack; Stationary Panel <i>9/25/00 - Present</i></p>		<p>11860424</p>
	<p>Jamb Spacer Tack; Stationary Panel <i>9/25/00 - Present</i> 3/4" Diameter Head</p>		<p>11860423</p>

CURRENT REPLACEMENT WOOD PARTS

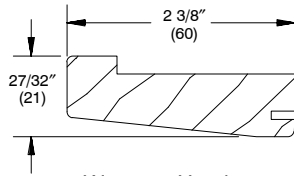
	Wood	Clad
Jamb Stop – UOAFD	W6531	W6531
Jamb Parting Stop – WUIAFD	W6535	–
Head Jamb Parting Stop – WUIAFD	W6554	–
Head Jamb Stop – UOAFD	W8598	W8598
First Mull Casing and Astragal – WUAFD	W1455	–
Sill Liner (oak) – UAFD	W2528	W2528
Astragal Cover – WUAFD	W7554	–
Stationary Sweep Filler – WUOAFD	W3297	–
Oak Sill Cover	W9510	–



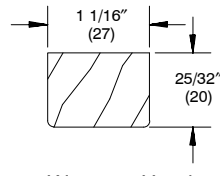
W6531 – Jamb Stop OAFD



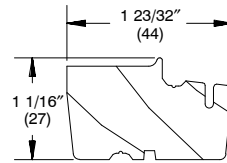
W6535 – Jamb Parting Stop WIAFD



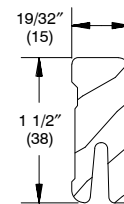
W6554 – Head Jamb Parting Stop WUIAFD



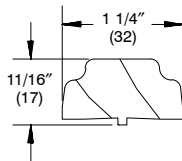
W8598 – Head Jamb Stop UOAFD



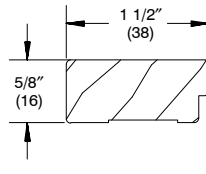
W1455 – First Mull Casing and Astragal WUAFD



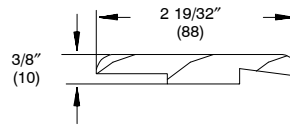
W2528 – Sill Liner (oak) UAFD



W7554 – Astragal Cover WUAFD



W3297 – Stationary Sweep Filler WUOAFD

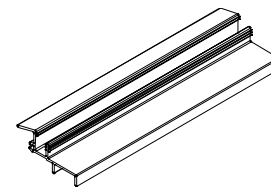


W9510 – Oak Sill Cover WUOAFD

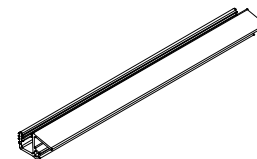
31/32\"/>

REPLACEMENT VINYL, ALUMINUM OR FIBERGLASS PARTS

	Wood	Clad
Stationary Panel Sill Spacer – Beige or Black	V941	V941
Panel Drip – Beige or Black	V940	V940
Panel Drip (In-Sash Transom) – Beige or Black	V800	V800
Sash Retainer (Transom) – Black	V026	V026
Sill Leveling Block (Transom) – Beige or Black	V027	V027
Hydro-Optimizer – Beige or Bronze	A1251	A1251
Head Jamb, Jamb Parting Stop	---	A1266
Mullion Casing Base	---	A771
Astragal Cladding	---	A772
Ultrex Sill, 4 9/16" Jamb – Beige or Bronze	F256	F256
Ultrex Sill, 6 9/16" Jamb – Beige or Bronze	F257	F257



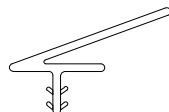
V941 – Stationary Panel Drip/Sill Spacer



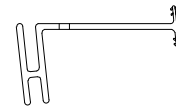
V940 – Panel Drip



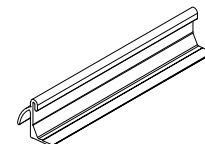
V800 – Panel Drip



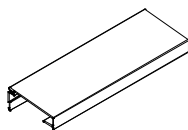
V026 – Sash Retainer



V027 – Sill Leveling Block



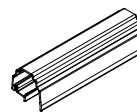
A1251 – Hydro-Optimizer



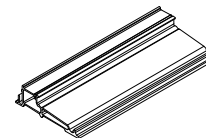
A1266 – Head Jamb, Jamb Parting Stop



A771 – Mullion Casing Base



A772 – Astragal Cladding

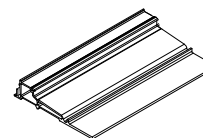


F256 – Ultrex Sill,* 4 9/16" Jamb

TO ORDER REPLACEMENT PARTS

When ordering replacement parts specify:

1. profile number;
2. rough opening;
3. length;
4. handing;
5. finish.



F257 – Ultrex Sill, 6 9/16" Jamb*

* Must specify Inswing or Outswing.

WEATHER STRIP

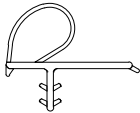

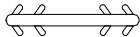
ULTIMATE ARCH TOP FRENCH DOORS

When ordering replacement weather strip specify:

1. quantity;
2. length;
3. part number;
4. description.

ILLUSTRATION <i>NOT TO SCALE</i>	DESCRIPTION	LENGTH	OPER./COLOR	PART NUMBER
	Weather strip, Sill <i>UOAF: 9/25/00 – Present</i> V776	87 11/16" 164 7/8" 164 7/8"	BG BG BK	11197276 11197296 11197297
	Weather strip, Stile <i>UOAF: 9/25/00 – Present</i> V020	79 7/16" 79 7/16" 83 7/16" 92 15/16" 92 15/16" 104 15/16" 104 15/16" 150" 150"	BG BK BG BG BK BG BK BG BK	11197968 11197969 11197970 11197982 11197981 11197990 11197991 11197999 11197998
	Weather strip, Frame <i>UOAF: 9/25/00 – Present</i> V017	41 5/16" 80 5/8" 94 1/8" 164 7/8" 164 7/8"	BG BG BG BG BK	11197536 11198668 11198682 11197596 11197598
	Pile Weather strip, Jamb or Panel <i>UOAF: 9/25/00 – Present</i> Adhesive backed 1 3/8" x 3/8" x 1/2"		GY	15600010
	Sweep, Active and Inactive Panel <i>UOAF: 9/25/00 – Present</i> V779	CN 2/6 CN 2/8 CN 3/0 CN 3/0	BG BG BG BK	11197426 11197428 11197430 11197431
	Sweep, Stationary Panel <i>UOAF: 9/25/00 – Present</i> V778	CN 3/0 150" 150"	BG BG BK	11197330 11197399 11197398
	Weather strip, Panel Cover <i>UOAF: 9/25/00 – Present</i> V018	150" 150"	BG BK	11197799 11197798
	Flex-Bulb Weather strip, Sill <i>UIAF: 9/25/00 – Present</i> V794	87 9/16" 164 3/4" 164 3/4"	BG BG BK	15180276 15180798 15180799
	Inactive Panel Stile Center <i>UIAF: 9/25/00 – Present</i> V780	150" 150"	BG BK	15174099 15174098

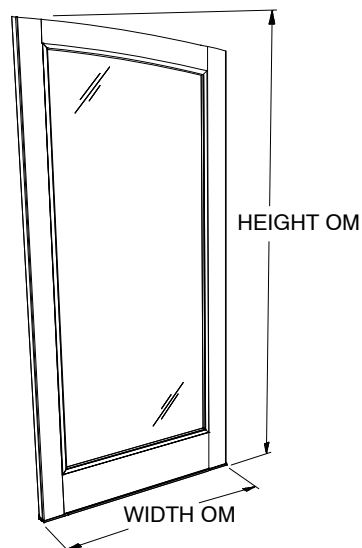
WEATHER STRIP

ILLUSTRATION <i>NOT TO SCALE</i>	DESCRIPTION	LENGTH	OPER./COLOR	PART NUMBER
	<p>Offset Bulb Weather strip, Parting Stop, Frame, Mull Casing, Transom and Astragal 9/25/00 – Present V796</p>	<p>41 1/4" 92 7/8" 92 7/8" 104 7/8" 104 7/8" 164 13/16"</p>	<p>BG BG BK BG BK BG</p>	<p>15171136 15170082 15170083 15170090 15170091 15172140</p>
	<p>Dust Block / Pile Jamb or Panel UIAF 9/25/00 – Present Adhesive backed</p> <p>1" x 1/8" x 3/4"</p>		<p>GY</p>	<p>19061221</p>
	<p>Connecting Barb 9/25/00 – Present V803 NOTE: Color may vary depending on current stock.</p> <p>Wood Door and Wood and Clad Transom only</p>	<p>Specify Length</p>		<p>15812999</p>

ORDERING REPLACEMENT PANELS FOR THE ULTIMATE ARCH TOP FRENCH DOOR

To order replacement panels specify:

1. OM of panel;
NOTE: OM of panel does not include astragal.
 - a. template required for Ultimate Arch Top French door panel prior to 7/14/03.
2. active, inactive or stationary
 - a. Active – specify no lock (no bore), bore for passage latch/dead bolt, single–point mortise lock or multi–point mortise lock.
 - b. Inactive – specify head or foot bolts or multi–point mortise lock.
 - c. Stationary – specify configuration and astragal or mull casing (if applicable).
3. handing;
4. glazing;
5. finish.
6. Glazing bead profile
 - a. Bevel
 - b. Square



**Inswing/Outswing Arch Top
Active Panel
Exterior View**

Active panels include: sweep and route for hinges.

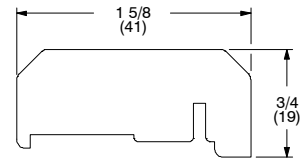
Inactive panels include: sweep, route for hinges, astragal and head and foot bolts.

Stationary panels include: leveling block.

ORDERING REPLACEMENT WOOD OR VINYL PARTS FOR ULTIMATE ARCH TOP FRENCH DOOR 5/98 – PRESENT

WOOD PARTS

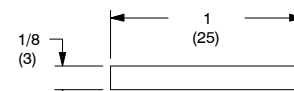
	Profile Number
Stationary Panel Head Jamb Spacer	W6126
Astragal	W7528



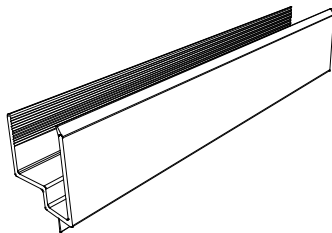
W7528 – Astragal

VINYL PARTS

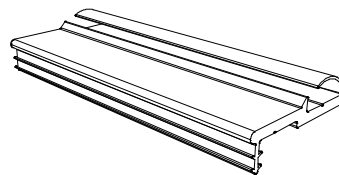
	Profile Number
Astragal Base/Weather strip – Beige	V822
Bottom Rail Filler	V200



W6126 – Stationary Panel
Head Jamb Spacer



V200 – Bottom Rail Filler



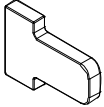
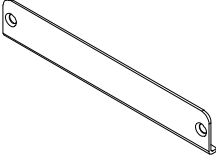
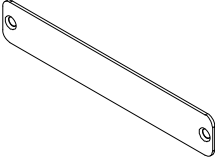
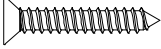
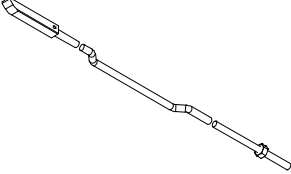
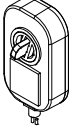

V822 – Astragal Base/Weather strip

TO ORDER REPLACEMENT PARTS

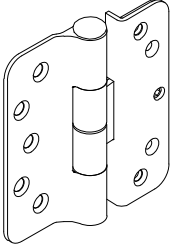
When ordering replacement combination wood or vinyl parts specify:

1. profile number;
2. length;
3. handing;
 - a. on jamb filler specify right or left jamb (viewed from exterior)
4. finish.

PARTS FOR LOCK STATUS SENSOR

ILLUSTRATION NOT TO SCALE	DESCRIPTION	OPER./ COLOR	PART NO.
	Tailpiece, Non-keyed, Button Switch	SS	10501844
	Cover, Transmitter, L-Shape <i>Used for Inswing Arch Top Doors</i>	BSS	10501821
	Cover, Transmitter <i>Used for Outswing Arch Top Doors</i>	BSS	10501822
	#8-18 x 1" Type AB, Full Thread <i>Used for Transmitter Covers</i> <i>Need quantity of 2 for each part</i>		11800769
	Lock Rod, Transmitter Recess, Shoot Bolt, LH <i>Used for Inswing Arch Top Doors</i>	BSS	10501838
	Lock Rod, Transmitter Recess, Shoot Bolt, RH <i>Used for Inswing Arch Top Doors</i>	BSS	10501841
	Micro Switch Assembly	BK	10501824
	Lock Rod, Transmitter Recess, Shoot Bolt at Sill, LH <i>Used for Outswing Arch Top Door</i>	BSS	10501839
	Lock Rod, Transmitter Recess, Shoot Bolt at Sill, RH <i>Used for Outswing Arch Top Door</i>	BSS	10501842

OBSOLETE – PARTS

ILLUSTRATION NOT TO SCALE	DESCRIPTION			
	<p>Hinge, Adjustable Usage Dates: July 2003 to July 30, 2012 Includes: 1 – Adjustable hinge 1 – #10x2 1/2" Phillips flathead wood screws (jamb) 5 – #10x1" Phillips flathead wood screws 4 – #8x1 1/2" Phillips flathead wood screws 1 – 5/32" Hex Key</p> <p>NOTE: Hinge part number includes the color matched screws. If you need to order the screws separately, they are listed below aligned with the corresponding hinge color.</p>			
SCREW DESCRIPTION	HINGE COLOR/PART NO.		SCREW COLOR/PART NO.	
	LH	RH		
1 – #10x2 1/2" Phillips flathead wood screws (jamb)	TP GT SF DKBZ* DKBZ AB WH SC ORBZ ORBZ PVD BS PVD SN PVD	NA** NA** NA** NA** NA** NA** NA** NA** NA** NA** NA** NA** NA**	NA** NA** NA** NA** NA** NA** NA** NA** NA** NA** NA** NA** NA**	TP 11800683 GT 11800681 SS 11800684 DKBZ 11800680 DKBZ 11800680 DKBZ 11800680 WH 11800682 SS 11800684 DKBZ 11800680 DKBZ 11800680 BS PVD 11800679 SS 11800684
5 – #10x1" Phillips flathead wood screws	TP GT SF DKBZ DKBZ AB WH SC ORBZ ORBZ PVD BS PVD SN PVD	NA** NA** NA** NA** NA** NA** NA** NA** NA** NA** NA** NA** NA**	NA** NA** NA** NA** NA** NA** NA** NA** NA** NA** NA** NA** NA**	TP 05580145 GT 11800606 SS 11800605 DKBZ 02050526 DKBZ 02050526 DKBZ 02050526 WH 11800603 SS 11800605 DKBZ 02050526 DKBZ 02050526 BS PVD 11800600 SS 11800605
4 – #8x1 1/2" Phillips flathead wood screws	TP GT SF DKBZ DKBZ AB WH SC ORBZ ORBZ PVD BS PVD SN PVD	NA** NA** NA** NA** NA** NA** NA** NA** NA** NA** NA** NA** NA**	NA** NA** NA** NA** NA** NA** NA** NA** NA** NA** NA** NA** NA**	TP 11865177 GT 11865172 SS 11865175 DKBZ 02058013 DKBZ 02058013 DKBZ 02058013 WH 11865173 SS 11865175 DKBZ 02058013 DKBZ 02058013 BS PVD 11865176 SS 11865175

* Used prior to April, 2010

** Contact your Marvin representative.

OBSOLETE – PARTS

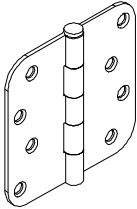
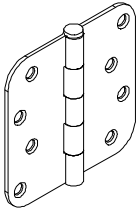
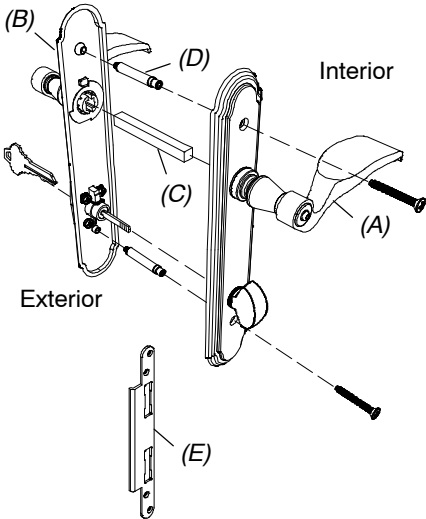
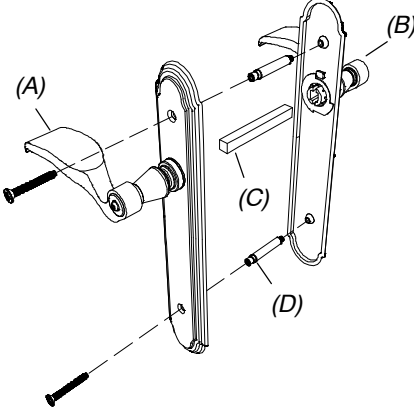
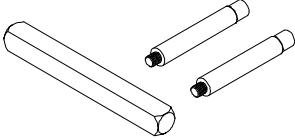
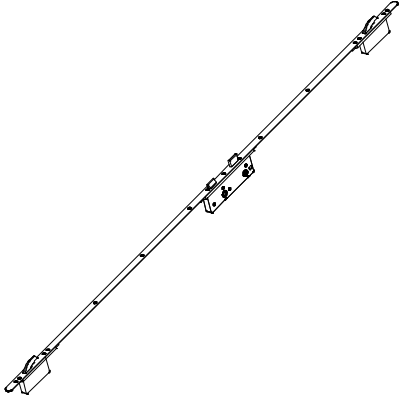
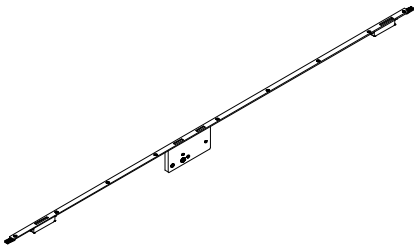
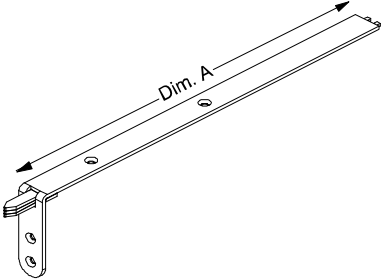
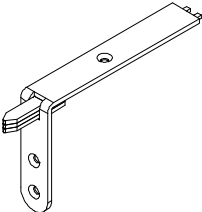
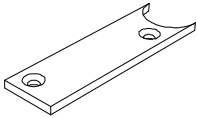
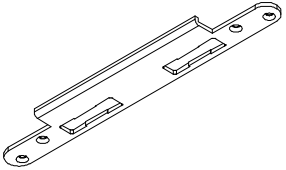
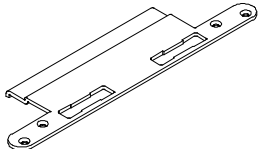
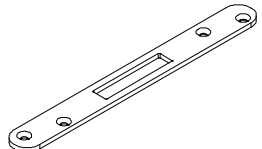
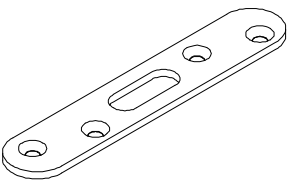
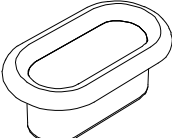
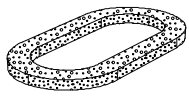
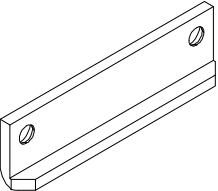





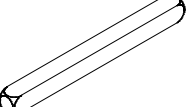



ILLUSTRATION NOT TO SCALE	DESCRIPTION	OPER./COLOR	PART NO.
	<p>Butt Hinge, Inswing Doors <i>Includes:</i> 1 - 4" hinge 3 - #9x1" Phillips flathead wood screws (panel) 2 - #9x3/4" Phillips flathead wood screws (frame) 1 - #10x2 1/2" Phillips flathead wood screws (frame) Brass 11800635 (pkg. of 4) Stainless Steel 11800639 (pkg. of 4)</p>	<p>Brass Plated Solid Brass SS</p>	<p>02100569 N/A N/A</p>
 <p>RP version shown</p>	<p>Butt Hinge, Outswing Doors <i>Includes:</i> 1 - 4" hinge 4 - #10x1" Phillips flathead wood screws (panel) 3 - #10x3/4" Phillips flathead wood screws (frame) 1 - #10x2 1/2" Phillips flathead wood screws (frame)</p>	<p>RP SS RP</p>	<p>N/A N/A</p>
	<p>Multi-Point Handle, Active, Solid Brass <i>Pre-2000 (Essve)</i> (Schlage keyway) <i>Includes:</i> 1 - Interior handle (A) with escutcheon plate and thumb turn 1 - Exterior handle (B) with escutcheon plate and keyed cylinder 1 - Spindle (C) 2 - Escutcheon mounting extensions (D) 1 - Jamb strike (center) (E) 2 - Keys 2 - #10 - 24x1 1/2" Phillips ovalhead machine screws 4 - #7x5/8" Phillips flathead wood screws (Strike)</p>	<p>LH RH</p>	<p>N/A (Current handle can be used by turning it upside down).</p>
	<p>Multi-Point Handle, Inactive, Solid Brass <i>Pre-2000 (Essve)</i></p>		<p>N/A (Current handle can be used by turning it upside down).</p>

ILLUSTRATION NOT TO SCALE	DESCRIPTION	OPER./CO LOR	PART NO.
	<p>Spindle Package for Multi-Point Handle Pre-2000 (Essve) Includes: 1 - Spindle 2 - Escutcheon mounting extensions</p>		N/A
	<p>Active Multi-Point Hardware Assembly Pre-2000 (Essve) Includes: 1 - Multi-Point hardware assembly (with mortise locks) 9 - #6x1 1/2" Phillips flathead wood screws</p>		N/A
	<p>Inactive Multi-Point Hardware Assembly Pre-2000 (Essve) Includes: 1 - Inactive multi-point hardware assembly 9 - #6X1 1/2" Phillips flathead wood screws</p> <p style="text-align: right;">CN 6-8 and 7-0 ht. CN 8-0 ht.</p>		N/A N/A
	<p>Multi-Point Top Corner Drive Pre-2000 (Essve) For Inactive panel with multi-point Includes: 1 - Top corner drive Attached with #6x1/2" Phillips flathead wood screws</p> <p style="text-align: right;">CN 6-8 ht. 7 29/64" (189) CN 7-0 ht. 11 15/32" (291) CN 8-0 ht. 10 5/16" (262)</p> <p>NOTE: For special heights give Dimension A.</p>		N/A N/A N/A
	<p>Multi-Point Bottom Corner Drive Pre-2000 (Essve) For Inactive panel with multi-point</p>		N/A


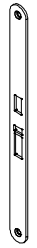
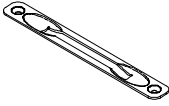
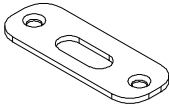
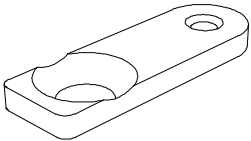
OBSOLETE – PARTS

ILLUSTRATION NOT TO SCALE	DESCRIPTION	OPER./CO LOR	PART NO.
	Corner Drive Filler, Multi-Point Lock <i>Pre-2000 (Essve)</i>		N/A
	Jamb Strike, Center, Solid Brass, Multi-Point Lock <i>Pre-2000 (Essve)</i> <i>Includes:</i> 1 – Jamb strike 4 – #7 x 5/8" Phillips flathead wood screws		N/A
	Jamb Strike, Center, Extended, Solid Brass, Multi-Point Lock <i>Pre-2000 (Essve)</i>		N/A
	Jamb Strike, Top or Bottom, Solid Brass, Multi-Point Lock <i>Pre-2000 (Essve)</i> <i>Includes:</i> 1 – Jamb strike 4 – #7 x 5/8" Phillips flathead screws		N/A
	Strike, Inactive Panel, Head Jamb, Multi-Point Lock <i>Pre-2000 (Essve)</i> <i>Includes:</i> 1 – Strike 4 – #7x5/8" Phillips flathead wood screws		N/A
	Corner Drive Sill Receptacle, Solid Brass, Multi-Point Lock <i>Pre-2000 (Essve)</i>		N/A
	Sill Receptacle Gasket, Multi-Point Lock For corner drive sill receptacle		N/A

OBSOLETE – PARTS

ILLUSTRATION NOT TO SCALE	DESCRIPTION	OPER./COLOR	PART NO.
	Astragal Strike Latch, Multi-Point Lock Pre-2000 (Essve) Inactive panel with multi-point hardware <i>Includes:</i> 1 – Latch 2 – #7x5/8" Phillips flathead wood screws		N/A
	Lever Washers – Pre – 2000		N/A
	Lever Spacers – Pre – 2000		N/A
	Lever Shims – Pre – 2000		N/A
	Dummy Lever Cams – Pre – 2000		N/A
	Snap Rings – Pre – 2000		N/A
	Spindle – Pre – 2000 4 3/16"		N/A
	Inactive Panel Flush Bolt 9/25/00 – 3/02 <i>Includes:</i> 1 – Flush bolt 4 – #6 x 1 1/2" Phillips flathead wood screws	Solid Brass Antique Brass Polished Chrome White	N/A N/A N/A N/A
	Strike Plate, Jamb-Mortise Lock or Multi-Point Lock 9/25/00 – 3/31/03 (Amerock) <i>Includes:</i> 1 – Jamb strike plate 2 – #8x1" Brass Phillips flathead wood screws	Polished Chrome Brushed Chrome White	N/A 05700121 N/A
	Stop clip with screws 9/25/00 – Present NA for individual part		N/A

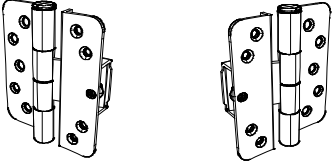
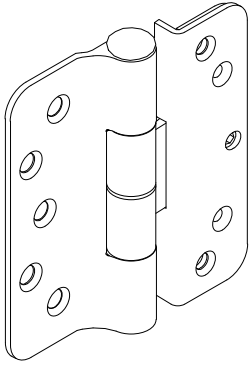
OBSOLETE – PARTS

ILLUSTRATION NOT TO SCALE	DESCRIPTION	OPER./COLOR	PART NO.
	Strike Plate, Inactive Panel-Mortise Lock or Multi-Point Lock 9/25/00 – 3/31/03 (Amerock) <i>Includes:</i> 1 – Jamb strike plate 2 – #8x1" Brass Phillips flathead wood screws	Polished Chrome Brushed Chrome White	N/A N/A N/A
	Cover Plate, Active Mortise Lock or Multi-Point Lock 9/25/00– 3/31/03 (Amerock) <i>Includes:</i> 1 – Cover plate 2 – #8x1" Phillips flathead wood screws	Polished Chrome Brushed Chrome White	N/A N/A N/A
	Cover Plate for Flush Bolt		N/A
	Strike Plate, Head Jamb WIAFD 9/25/00 – 3/31/03 <i>Includes:</i> 1 – Strike plate 2 – #8x1" Phillips flathead wood screws (head jamb)	Polished Chrome Brushed Chrome White Brass Antique Brass	10148048 N/A N/A 10148045 NA
	Strike Plate, Sill WIAFD 9/25/00 – 3/31/03 <i>Includes:</i> 1 – Strike plate – 05700018 2 – #8x 1/2" Phillips flathead machine screws (sill) 2 – Well-nut #8 machine screw (sill) 10830008	Polished Chrome Brushed Chrome White Brass Antique Brass	N/A 18900364 N/A 18900360 N/A
	Strike Plate, Head Jamb & Sill UIAF <i>Includes:</i> 2 – Strike plates 2 – #8x 1" Phillips flathead wood screws 2 – #8x 1 1/2" Phillips flathead machine screws	PVD Brass	N/A
	Inactive Panel Backset Extension for Head or Foot Bolt 9/25/00 – Present With 1/4" – 20 threads <i>Includes:</i> 1 – Backset extension 1 – 1/4" –20 x3/4" Phillips flathead machine screw		N/A

OBSOLETE – PARTS

ILLUSTRATION NOT TO SCALE	DESCRIPTION	OPER./COLOR	PART NO.
	<p>Handle Assembly, Active Panel Mortise lock and Multi-point lock systems (Schlage “C” keyway) Includes: 1 – Interior lever (A) with 00142006 spindle, escutcheon plate and hardware 1 – Exterior lever (B) with escutcheon plate and hardware 1 – Thumb turn (C) with hardware 1 – Keyed cylinder (D) with housing and hardware 1 – Exterior escutcheon plate gasket (E) 1 – Exterior escutcheon plate (F) 1 – Two piece spindle (G) 2 – #10–32x2” Phillips ovalhead machine screws (H) 1 – Interior Escutcheon plate (I) 2 – Keys</p>	<p>Polished Chrome</p>	<p>10148117</p>
	<p>Handle Assembly, Inactive/Dummy Includes: 1 – Interior lever (A) with 00142006 spindle, escutcheon plate and hardware 1 – Exterior lever (B) with escutcheon plate and hardware 1 – Exterior escutcheon plate gasket (C) 1 – Exterior escutcheon plate (D) 1 – Two piece spindle (E) 2 – #10–32x2” Phillips ovalhead machine screws (F) 1 – Interior Escutcheon plate (G)</p>	<p>Polished Chrome</p>	<p>10148148</p>
	<p>Installation Screw Package; Strike Plate(s) at head jamb, sill, or locking jamb #8 x 2 1/2” Flathead wood screw Package of 4</p>	<p>White</p>	<p>11882348</p>

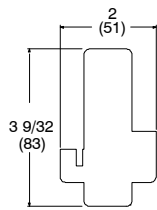
OBSOLETE – PARTS

ILLUSTRATION NOT TO SCALE	DESCRIPTION	OPER./COLOR	PART NO.
	<p>Hinge, Adjustable, Left Hand- Right Hand <i>2000-2005</i></p>	<p>Polished Chrome Satin Taupe Gold Tone Silver Frost Dark Bronze White</p>	<p>N/A Use current hinge (All hinges must be changed on panel)</p>
	<p>Hinge, Adjustable <i>Includes:</i> 1 - Adjustable hinge 1 - #10x2 1/2" Phillips flathead wood screws (jamb) 4 - #10x1" Phillips flathead wood screws (jamb) or 5 - #10x1" Phillips flathead wood screws (stationary stile) 4 - #8x1 1/2" Phillips flathead wood screws (panel) 1 - 5/32" Allen wrench (adjustment)</p>	<p>PC</p>	<p>Right Hand NA</p> <hr/> <p>Left Hand NA</p>

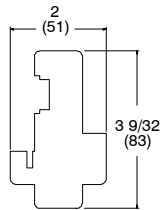
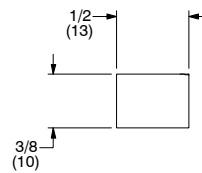
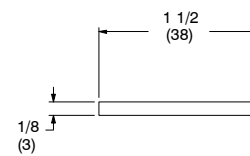
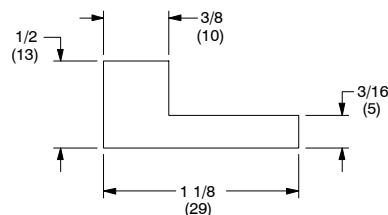
CURRENT REPLACEMENT WOOD PARTS**FRENCH ARCH TOP INSWING AND OUTSWING**

	Wood
Astragal	W7222
Astragal (Multi-Point)	W7219
Stationary Head Jamb, Jamb and Astragal Filler	W6040*
Stationary Head Jamb and Jamb Spacer	W6220*
Stationary Jamb Filler (Multi-panel)	W7235*

* No longer available.



W7222 – Astragal

W7219 – Astragal
(Multi-Point)W6040* – Stationary
Head Jamb, Jamb
and Astragal FillerW6220* – Stationary Head
Jamb and Jamb SpacerW7235* – Stationary Jamb
Filler (Multi-panel)**TO ORDER REPLACEMENT WOOD PARTS**

When ordering replacement wood parts specify:

1. profile number;
2. call number or rough opening;
3. handing;
 - a. for operator first mull casing specify right or left hand (as viewed from the exterior)
 - b. for astragal specify hardware prep (if applicable)
4. length;
5. finish;
6. radius (if applicable).

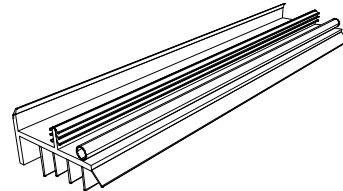
OBSOLETE – REPLACEMENT PARTS

ORDERING REPLACEMENT VINYL, ALUMINUM OR FIBERGLASS PARTS FOR ARCH TOP FRENCH DOORS

FRENCH ARCH TOP INSWING

	Wood
Sweep – Beige	V302
Stationary and Sidelite Leveling Block – Beige	V199*
Ultrax Sill (4 9/16" Jamb) – Beige	F251*
Ultrax Sill (6 9/16" Jamb) – Beige	F253*

* No longer available

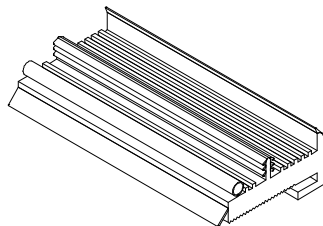


V302 – Sweep

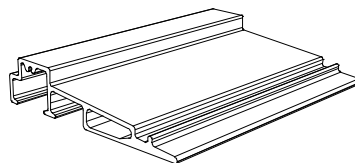
FRENCH ARCH TOP OUTSWING

	Wood
Sweep – Beige	V212*
Stationary and Sidelite Leveling Block – Beige	V770*
Ultrax Sill – Beige	F252*

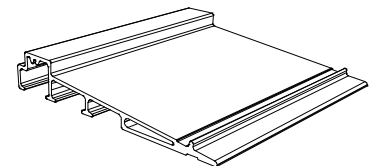
* No longer available



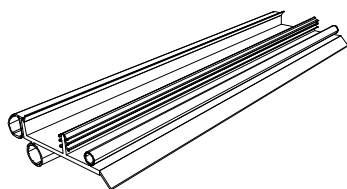
*V199 – Stationary and Sidelite Leveling Block
No longer available



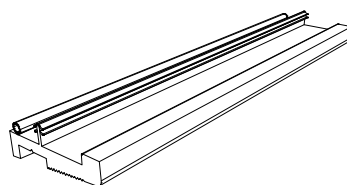
*F251 – Ultrax Sill (4 9/16" Jamb)
No longer available



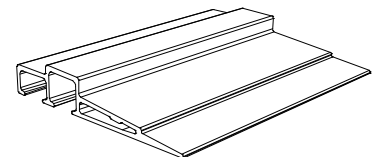
*F253 – Ultrax Sill (6 9/16" Jamb)



*V212 – Sweep



*V770 – Stationary and Sidelite Leveling Block



*F252 – Ultrax Sill

TO ORDER REPLACEMENT PARTS

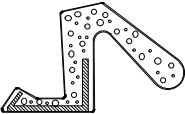
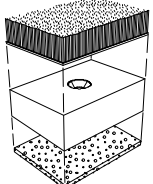
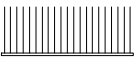
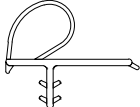

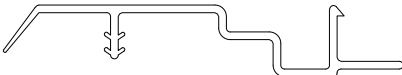
When ordering replacement parts specify:

1. profile number;
2. size (call number or rough opening);
3. length;
4. handing;
5. finish (where applicable).

OBSOLETE – WEATHER STRIP**FRENCH DOORS AND ARCH TOP FRENCH DOOR WEATHER STRIP**

When ordering replacement weather strip specify:

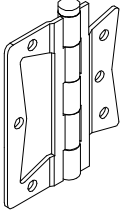
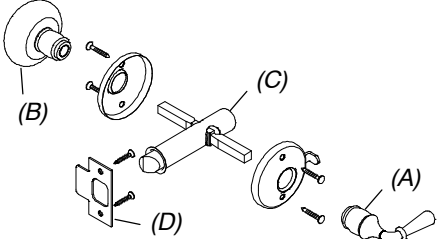
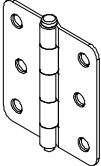
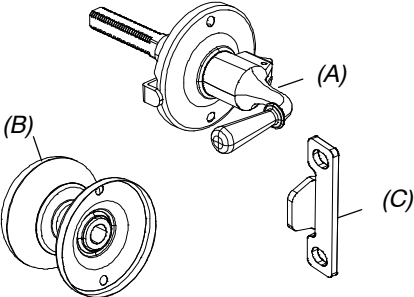
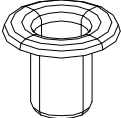
1. quantity;
2. length;
3. part number;
4. description.

ILLUSTRATION <i>NOT TO SCALE</i>	DESCRIPTION	LENGTH	PART NUMBER
	Foam Weather strip, Frame V650 Color: Beige	144"	NA
	Sill Dust Block Assembly Inswing doors only		N/A
	Pile Weather strip, Sill Adhesive backed Outswing doors only Color: Beige 13/16" x 13/32" x 1 15/16"		N/A
	Offset Bulb Weather strip, Parting Stop, Frame, Mull Casing, Transom and Astragal V796 Color: Beige	189 11/16"	15173298
	Weather strip, Stile V020 Color: Beige	95 9/16"	11197980
	Weather strip, Frame V017 Color: Beige	164 5/32"	11197596

WOOD INSWING ARCH TOP COMBINATION DOOR PARTS

When ordering replacement combination parts specify:

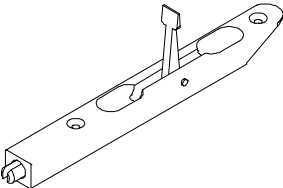
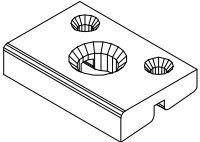
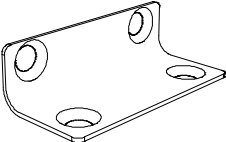
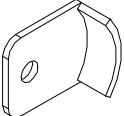
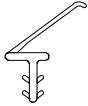

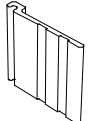
1. part number;
2. quantity;
3. description.

ILLUSTRATION NOT TO SCALE	DESCRIPTION	OPER./CO LOR	PART NO.
	<p>Surface Mount Hinge Pair, Solid Brass</p>		N/A
	<p>Handle Package, Solid Brass</p> <p><i>Includes:</i></p> <ul style="list-style-type: none"> 1 - Interior handle (A) with locking rose 1 - Exterior handle (B) with rose 1 - Latch bolt assembly (C) 1 - Strike (D) 4 - #6x3/4" Phillips ovalhead wood screws (handle) 2 - #4x3/4" Phillips ovalhead wood screws (strike) 		02550630
	<p>Hinge, Solid Brass WIAFD</p>		N/A
	<p>Handle Package, Solid Brass WIAFD</p> <p><i>Includes:</i></p> <ul style="list-style-type: none"> 1 - Interior locking handle assembly (A) with rose 1 - Exterior handle (B) with rose 1 - Strike (C) 05700033 4 - #5x5/8" Phillips ovalhead wood screws (handle) 2 - #8x5/8" panhead wood screws (strike) 		11100301
	<p>Thimble Headbolt receiver</p>	BS	02540664

WOOD INSWING ARCH TOP COMBINATION DOOR PARTS

When ordering replacement combination parts specify:

1. part number;
2. quantity;
3. description.

ILLUSTRATION NOT TO SCALE	DESCRIPTION	OPER./CO LOR	PART NO.
	Head or Foot Bolt, Solid Brass <i>Includes:</i> 1 - Bolt assembly 2 - #6x1 1/4" Phillips flathead wood screws		00143068
	6 9/16" Sill Strike Foot bolt receiver 1 - Sill strike 2 - #4x1/2" Phillips flathead screws	BG	05700031 Specify prep. for combination
	Stationary Panel Bracket <i>Includes:</i> 1 - Stationary panel bracket 4 - #7x3/4" Phillips flathead wood screws		11841000
	Keeper, Storm Insert Inswing French Door 5/98 – Present		00143062
	Drip Cap, Storm Insert Inswing French Door 5/98 – Present V795 144" pc	BG BK	NA 15646069
	Leaf Spring, Screen Insert Inswing French Door 5/98 – Present		NA
	Finger Pull, Screen Insert Inswing French Door 5/98 – Present V254	Clear	N/A