

ULTIMATE DOUBLE HUNG TILT PAC ULTIMATE WOOD DOUBLE HUNG TILT PAC

Table of Contents

	PAGE
History – Ultimate and Ultimate Wood Double Hung Tilt Pac	2
Replacement Parts	
Parts – Ultimate and Ultimate Wood Double Hung Tilt Pac	4
Balances – Ultimate and Ultimate Wood Double Hung Tilt Pac	8
Jamb Liners – Ultimate and Ultimate Wood Double Hung Tilt Pac	10
Jamb Hardware Assemblies – Ultimate and Ultimate Wood Double Hung Tilt Pac	11
Wood Parts – Ultimate and Ultimate Wood Double Hung Tilt Pac	13
Weather Strip – Ultimate and Ultimate Wood Double Hung Tilt Pac	14
Sash Replacement – Ultimate and Ultimate Wood Double Hung Tilt Pac	15

ATTENTION:

- Specification and technical data are subject to change without notice.
- Numbers listed in parentheses () are metric equivalents in millimeters rounded to the nearest whole number.

PRODUCED	UNIT TYPE	FEATURES OR CHANGES	STATUS
1982	Ultimate Wood Double Hung Tilt Pac	Tilt Pac introduced. Replacement kit contained: sash, jamb liners, balance assemblies and sash brackets.	Present
1985	Ultimate Wood Double Hung Tilt Pac	Changed from mousetrap (luggage) style lock to cam style lock.	1993
1985	Marv-A-Gard Tilt Pac	Marv-A-Gard Tilt Pacs introduced in January with extruded aluminum sash in 3/4" insulating 1 lite glazing only. (The term Marv-A-Gard was discontinued in 1986.)	Present
1985	Marv-A-Gard E-Z Tilt	Extruded aluminum clad sash introduced for Marv-A-Gard E-Z Tilt in November which allowed for 3/4" glazing. Authentic divided lite and single glazed 1 lite remained Polycron sash.	1999 Units Present Tilt Pac
1989	Ultimate and Ultimate Wood Double Hung Tilt Pac	Beige jamb liner standard on pebble gray and bronze exterior.	Present
		White jamb liner standard on brown and white exterior.	1990
1990	Ultimate and Ultimate Wood Double Hung Tilt Pac	Beige jamb liner standard.	Present
1992	Ultimate and Ultimate Wood Double Hung Tilt Pac	Cam pivot redesigned. Brass hardware introduced. Upgraded extra heavy duty balance system to extra heavy duty 2. Bottom rail weather strip profile changed and color changed from white to beige.	Present
1992	Ultimate Wood Double Hung Tilt Pac	Simulated Divided Lites introduced.	Tilt Pac Present
1993	Ultimate and Ultimate Wood Double Hung Tilt Pac	Sash lock changed to spring loaded sash lock.	Ultimate 1999 Ultimate Wood 2001 Tilt Pac Present
1993	Ultimate Double Hung Tilt Pac	Simulated divided lite introduced.	Present
1996	Ultimate Double Hung Tilt Pac	Custom sill bevels introduced	Present
1998	Ultimate Double Hung Tilt Pac	11/98 Units utilizing .75" insulating glass overall thickness reduced to .70". No changes needed to existing glass size (width or height) or glazing system. Replacement glass will be sent .70" for units manufactured utilizing .75" glass.	Present
2000	Ultimate Wood Double Hung Tilt Pac	1/30/00 Sash lift changed to Ultimate style lift.	Present
2001	Wood E-Z Tilt DH/SH, Picture & Transom	After 2/12/01 the Wood E-Z Tilt rectangle products will no longer be available. Wood E-Z Tilt Pac remains unchanged.	2001
2004	Ultimate and Ultimate Wood Double Hung Tilt Pac	1/04 Added Oil Rubbed Bronze and Satin Chrome to available hardware finishes	Present
2004	Ultimate and Ultimate Wood Double Hung Tilt Pac	6/14/04 Satin Nickel hardware introduced.	Present
2008	Ultimate Double Hung Tilt Pac	7/28/2008 Mixed grain Douglas fir is now a standard option.	Present

PRODUCED	UNIT TYPE	FEATURES OR CHANGES	STATUS
2009	All	3/23/2009 Added LoE ³ -366™ as a standard option for all products. Added Cedro Macho as a standard option for all Ultimate products.	Present
2011	All	04/25/2011 Added LoE-180™ as a standard option for all products. White painted interior finish option introduced for all products.	Present
2012	All	12-17-2012 Introduced Clear interior finish option on all products.	Present
2013	All	04/29/2013 Introduced interior stain options. Stain colors are Wheat, Honey, Leather, Hazelnut, Cabernet and Espresso.	Present

When ordering replacement parts specify:

1. type of unit;
2. part number;
3. description.

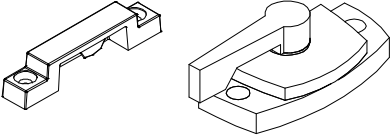
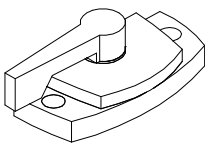
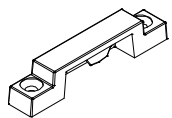
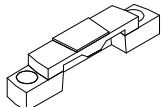
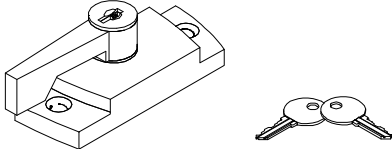
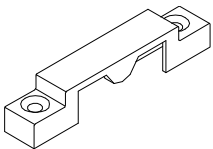
ILLUSTRATION <i>NOT TO SCALE</i>	DESCRIPTION	OPERATION/ COLOR	PART NO.
	<p>Sash Lock and Keeper, Complete Package of 200</p> <p><i>Includes:</i> 200 – Sash lock 200 – Keeper 800 – #7x7/8" Phillips flathead wood screws</p>	Satin Taupe Bronze White	11900925 11900920 11900910
	<p>Sash Lock and Keeper, Complete</p> <p><i>Includes:</i> 1 – Sash lock 1 – Keeper 4 – #7 x 7/8" Phillips flathead wood screws</p>	Satin Taupe Bronze White	11869399 11869395 11869396
	<p>Sash Lock</p> <p><i>Includes:</i> 1 – Sash lock 2 – #7 x 7/8" Phillips flathead wood screws</p>	Satin Taupe Bronze White Brass Antique Brass Polished Chrome Satin Chrome Oil Rubbed Bronze Satin Nickel	10818034 10818033 10840026 05600082 05600084 05600086 05600088 05600090 05600092
	<p>Keeper</p> <p>Usage: 10–15–2012 – Present</p> <p><i>Includes:</i> 1 – Keeper 2 – #7 x 7/8" Phillips flathead wood screws</p>	Satin Taupe Bronze White Brass Antique Brass Polished Chrome Satin Chrome Oil Rubbed Bronze Satin Nickel	10818052 10818051 10818050 10818053 10818054 10818055 10818056 10818057 10818058
	<p>Keeper – Pre 10–15–2012</p>	No longer available – Use current keeper	
	<p>Sash Lock, Keyed</p> <p><i>Includes:</i> 1 – Keyed lock 2 – Keys 2 – #6x1" Phillips flathead wood screws</p>	Satin Taupe Bronze White	05590634 05590632 05590633
	<p>Keeper</p> <p>For keyed sash lock</p> <p><i>Includes:</i> 1 – Keeper 2 – #6x1" Phillips flathead wood screws</p>	Satin Taupe Bronze White	10817047 10817043 10840014

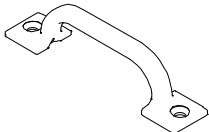

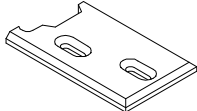
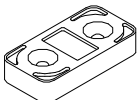
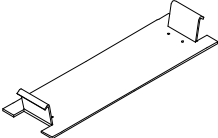



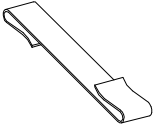
ILLUSTRATION NOT TO SCALE	DESCRIPTION	COLOR	PART NO.
	<p>Sash Lift Includes: 1 - Sash lift 2 - #8 x 1, Slotted oval head sheet metal screws</p>	<p>Satin Taupe Bronze White Brass Antique Brass Polished Chrome Satin Chrome Oil Rubbed Bronze Satin Nickel</p>	<p>10500598 10500557 10500556 10500558 10500597 10500595 10500596 10500601 10500602</p>
 <p>Left Hand Right Hand</p>	<p>Sash Pivot, Winged Includes: 1 - Sash pivot 1 - 1 5/8, Phillips trimhead self tapping screw NOTE: Pivot handing is viewed from the interior.</p>	<p>LH RH</p>	<p>11869348 11869347</p>
	<p>Sash Retainer Plate Includes: 1 - Sash retainer plate 2 - #7x7/8, Phillips flathead wood screws</p>	<p>LH Bronze RH Bronze LH White RH White</p>	<p>11870474 11870473 11870476 11870475</p>
	<p>Sash Limiter M726 Includes: 1 - Sash limiter 2 - #6x5/8, Phillips flathead wood screws</p>	<p>Beige</p>	<p>05070431</p>
	<p>Installation Clip, Jamb Liner M112 1, x 3 3/8,</p>		<p>11860011</p>
	<p>S-Hook, Short, 1/4, (6) Wide Top sash balance Used for Regular and Heavy Duty balances</p>		<p>11870727</p>
	<p>S-Hook, Long, 1/4, (6) Wide Bottom sash balance Used for Regular and Heavy Duty balances</p>		<p>11870731</p>
	<p>S-Hook Heavy Duty, Short, 3/8, (10) Wide Top sash balance Used for Extra Heavy Duty 2 balance</p>		<p>11870737</p>
	<p>S-Hook Heavy Duty, Long, 3/8, (10) Wide Bottom sash balance Used for Extra Heavy Duty 2 balance</p>		<p>11870741</p>

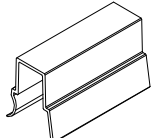
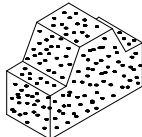
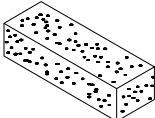
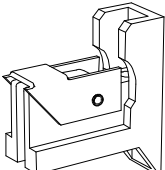
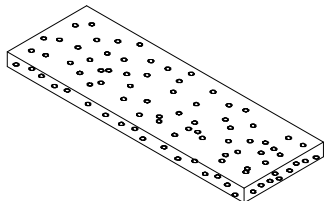
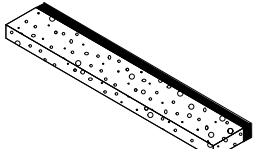
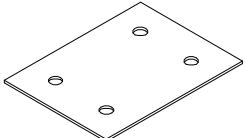
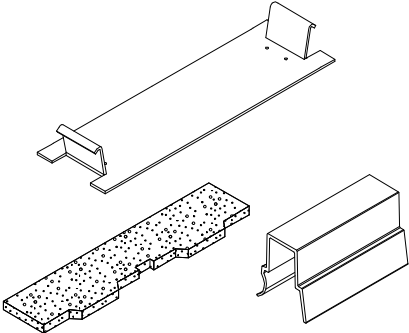
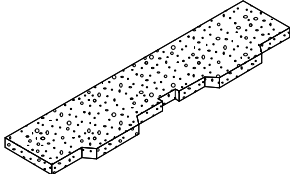
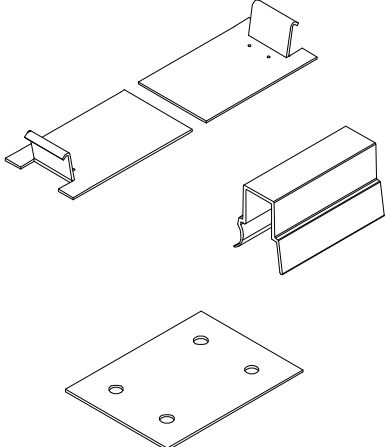
ILLUSTRATION <i>NOT TO SCALE</i>	DESCRIPTION	COLOR/LENGTH	PART NO.
	Sash Stop, Vinyl V177 1 3/4" (44) length	White Beige	11860114 11860116
	Foam Plug (Chimney Block) Located at the bottom of the vinyl jamb liner 1"x9/16"x3/4"	White	10502001
	Foam, Adhesive Backed Foam block on the back of the jamb liner 1/2"x1 1/2"x3/8"	Black	10500200
	Clutch Regular Heavy Duty Extra Heavy Duty Super Heavy Duty	Beige Black Blue Brown	11870480 11870482 11870481 11870483
	Jamb Liner Foam Located behind the vinyl jamb liner 7/16"x2 3/4"	Specify Length	10500009
	Jamb Liner Foam, Single Hung MISC 004 With PVC edge 9/16"x1 7/16"	Specify Length	10500014
	Sash Bracket, Single Hung M111 <i>Includes:</i> 1 - Sash bracket 4 - #6x5/8" Phillips Flathead screws	Mill Finish	11040360

ILLUSTRATION NOT TO SCALE	DESCRIPTION	COLOR	PART NO.
	<p>Tilt Pac Hardware Box Double Hung Tilt Pac only Package includes two sash stops</p> <p><i>Includes:</i> 2 - Foam gaskets - 10500100 2 - White sash stops - 11860114 2 - Beige sash stops - 11860116 10 - Installation clips - 11860011 1 - Instruction - 19970103</p>		11900510
	<p>Foam Gasket, Tilt Pac Top Track</p> <p>NOTE: For single hung cut to fit</p> <p>Ultimate Wood Ultimate</p>	White	10500100 10500102
	<p>Installation Clip, Jamb Liner Single Hung Tilt Pac Only</p> <p>Package of 8</p> <p><i>Includes:</i> 1 - Split installation clip 2 - Sash stops 4 - Sash brackets 16 - #6x5/8" Phillips Flathead screws</p>	White Beige	11900790 11900795

DOUBLE HUNG BALANCES 1975 TO PRESENT

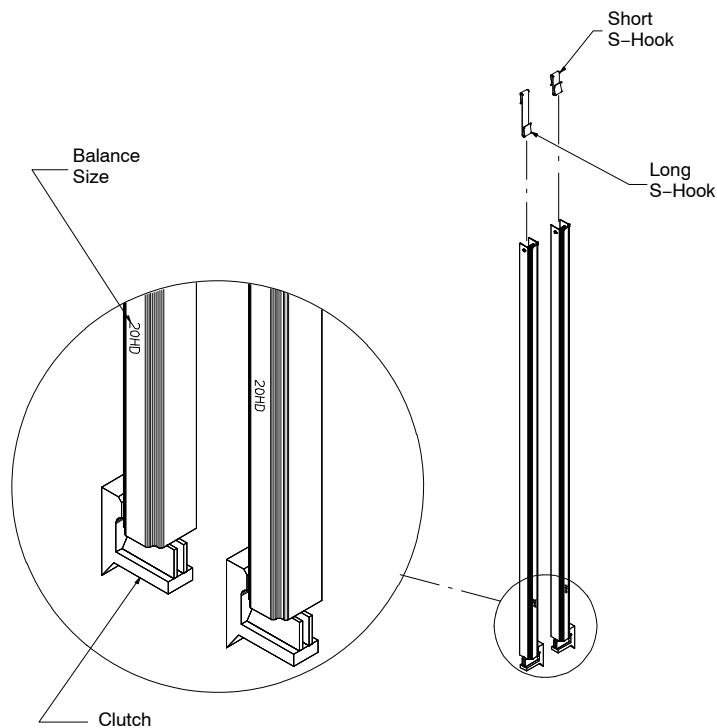
When ordering replacement balance tubes, provide the following information:

1. Provide an original order number
2. Provide a part number*. Part numbers can be determined by using the balance size (see illustration) and referring to the chart on the next page.
NOTE: Size of balance is imprinted on tube.
3. Specify top or bottom sash. The balance tube for the top sash is in the exterior track and has a short S-hook. The balance tube for the bottom sash is in the interior track and has a long S-hook.
4. Specify the quantity. Do **NOT** specify as *pairs* or *sets*. If one tube is needed, specify: qty 1. If four tubes are needed, specify: qty 4.

* In some applications a part number will not be available. In this case, please provide as much of the above information as possible along with the glass size and glass make-up.

NOTE: If an energy panel was installed after the original purchase, a heavier balance may be necessary.

NOTE: S-hook(s) are provided when balance tubes are ordered.



E-Z TILT BALANCED CLUTCHES ARE COLOR CODED

Part numbers listed below are for one balance only. Each sash requires two balances.

Specify top or bottom sash. T = Top Sash B = Bottom Sash							
Regular (White Clutch)		Heavy Duty (Black Clutch)		Extra Heavy Duty (Blue Clutch)		Super Heavy Duty (Brown Clutch)	
Size	Part Number	Size	Part Number	Size	Part Number	Size	Part Number
8" B	10660800	8" B	10670800	12" B	10681200	12" B	10691200
8" T	10660801	8" T	10670801	12" T	10681201	12" T	10691201
10" B	10661003	10" B	10671000	14" B	10681400	14" B	10691400
10" T	10661004	10" T	10671001	14" T	10681401	14" T	10691401
12" B	10661200	12" B	10671200	16" B	10681600	16" B	10691600
12" T	10661201	12" T	10671201	16" T	10681601	16" T	10691601
14" B	10661400	14" B	10671400	18" B	10681800	18" B	10691800
14" T	10661401	14" T	10671401	18" T	10681801	18" T	10691801
16" B	10661600	16" B	10671600	20" B	10682000	20" B	10692000
16" T	10661601	16" T	10671601	20" T	10682001	20" T	10692001
18" B	10661800	18" B	10671800	22" B	10682200	22" B	10692200
18" T	10661801	18" T	10671801	22" T	10682201	22" T	10692201
20" B	10662000	20" B	10672000	24" B	10682400	24" B	10692400
20" T	10662001	20" T	10672001	24" T	10682401	24" T	10692401
22" B	10662200	22" B	10672200	26" B	10682600	26" B	10692600
22" T	10662201	22" T	10672201	26" T	10682601	26" T	10692601
24" B	10662400	24" B	10672400	28" B	10682800	28" B	10692800
24" T	10662401	24" T	10672401	28" T	10682801	28" T	10692801
26" B	10662600	26" B	10672600	30" B	10683000	30" B	10693000
26" T	10662601	26" T	10672601	30" T	10683001	30" T	10693001
28" B	10662800	28" B	10672800	32" B	10683200	32" B	10693200
28" T	10662801	28" T	10672801	32" T	10683201	32" T	10693201
30" B	10663000	30" B	10673000	34" B	10683400	34" B	10693400
30" T	10663001	30" T	10673001	34" T	10683401	34" T	10693401
32" B	10663200	32" B	10673200	36" B	10683600	36" B	10693600
32" T	10663201	32" T	10673201	36" T	10683601	36" T	10693601
34" B	10663400	34" B	10673400	38" B	10683800	38" B	10693800
34" T	10663401	34" T	10673401	38" T	10683801	38" T	10693801
36" B	10663600	36" B	10673600	40" B	10684000	40" B	10694000
36" T	10663601	36" T	10673601	40" T	10684001	40" T	10694001
38" B	10663800	38" B	10673800	42" B	10684200	42" B	10694200
38" T	10663801	38" T	10673801	42" T	10684201	42" T	10694201
40" B	10664000	40" B	10674000	44" B	10684400	44" B	10694400
40" T	10664001	40" T	10674001	44" T	10684401	44" T	10694401
42" B	10664200	42" B	10674200				
42" T	10664201	42" T	10674201				
44" B	10664400	44" B	10674400				
44" T	10664401	44" T	10674401				

ORDERING REPLACEMENT CLIP MOUNT JAMB LINERS FOR TILT PAC

Replacement jamb liners include a pair of clip mount vinyl jamb liners, jamb liner foam, foam plugs, foam gaskets, pile weather strip, adhesive backed foam block and sash stops.

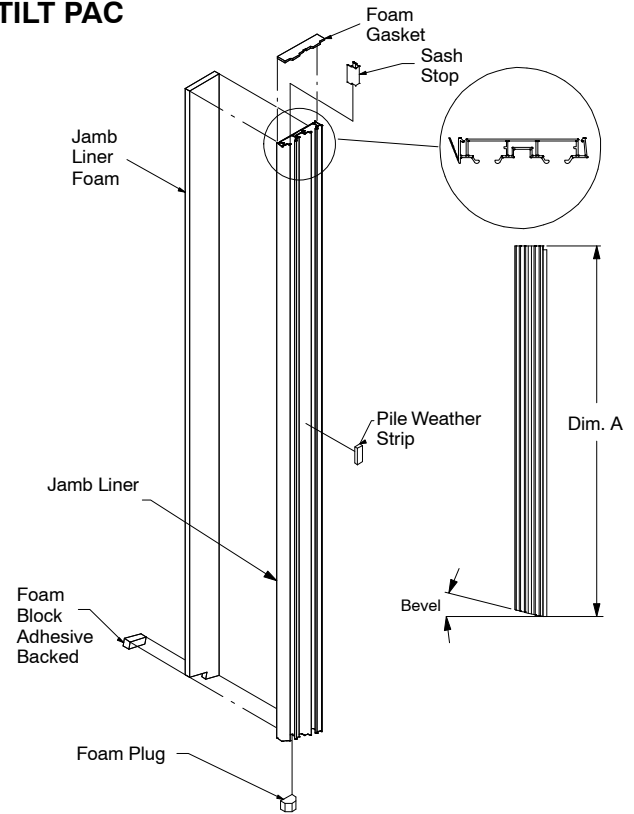
Jamb liners for standard Tilt Pac may be ordered by part number from the chart below.

NOTE: Jamb liners must be ordered in pairs

When ordering jamb liners for special sized Tilt Pacs, please provide the following information:

1. Original order number if available
2. Specify Tilt Pac type (DH or SH).
3. Specify clip mount.
4. Provide length (see dimension A on illustration) or glass height (s).
5. Specify color (beige or white).
6. Provide sill bevel. (Standard bevel is 14°).

NOTE: Special bevel jamb liners are shipped long to be trimmed in the field



Glass Height (one sash)	Part Number (White)	Part Number (Beige)
12" Pair*		
14" Pair*		
16" Pair	10561600	10570016
18" Pair	10561800	10570018
20" Pair	10562000	10570020
22" Pair	10562200	10570022
24" Pair	10562400	10570024
24/36" Pair*		
26" Pair	10562600	10570026
28" Pair	10562800	10570028
30" Pair	10563000	10570030
32" Pair	10563200	10570032
34" Pair	10563400	10570034
36" Pair	10563600	10570036
40" Pair		10570040
48" Pair*		
144"	10569000	10570099

* Contact your Marvin representative for ordering information.

ORDERING REPLACEMENT JAMB HARDWARE FOR TILT PAC

Replacement jamb hardware assemblies complete include a pair of clip mount vinyl jamb liners, jamb liner foam, foam plugs, foam gaskets, pile weather strip, adhesive backed foam block, sash stops, installation clips, S-hooks and balance tubes.

NOTE: Jamb liners must be ordered in pairs

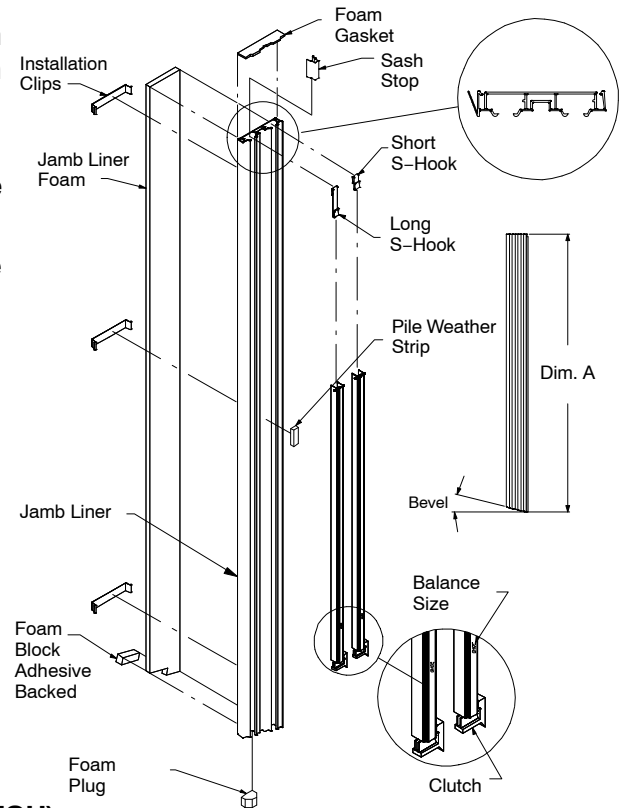
Jamb Hardware Assemblies Complete for standard Tilt Pacs may be ordered by part number. See charts below.

Jamb Hardware Assemblies complete for special Tilt Pacs, please include the following information:

1. Provide original order number if available.
2. Specify type of Tilt Pac, (DH or SH).
3. Specify clip mount.
4. Specify color of liner (beige or white).
5. Provide length (see dimension A) or glass height (s).
6. Provide balance size(s)* The balance size is imprinted on the tube, (see illustration).
7. Provide sill bevel. (Standard bevel is 14°).

NOTE: Special bevel jamb liners are shipped long to be trimmed in the field

* If the balances are oversized, a balance size may not be available. In this case, provide the glass width, height and makeup.



REGULAR (WHITE CLUTCH)

Glass Height (one sash)	Part Numbers White	Part Numbers Beige
12" Pair	10585012	10581112
14" Pair	10585014	10581114
16" Pair	10585016	10581116
18" Pair	10585018	10581118
20" Pair	10585020	10581120
22" Pair	10585022	10581122
24" Pair	10585024	10581124
24/36" Pair *	10585025	10581137
24/36" ** Reg/HD	10605012	10600012
26" Pair	10585026	10581126
28" Pair	10585028	10581128
30" Pair	10585030	10581130
32" Pair	10585032	10581132
34" Pair	10585034	10581134
36" Pair	10585036	10581136
40" Pair	10585040	10581140

* Glass height of top sash 24". Glass height of bottom sash 36". (all clutches white)

** Glass height of top sash 24". Glass height of bottom sash 36" (2 clutches white, 2 clutches black)

CLIP MOUNT REPLACEMENT JAMB HARDWARE FOR E-Z TILT PAC (CONT.)

HEAVY DUTY (BLACK CLUTCH)			EXTRA HEAVY DUTY (BLUE CLUTCH)		
Glass Height (one sash)	Part Numbers White	Part Numbers Beige	Glass Height (one sash)	Part Numbers White	Part Numbers Beige
12" Pair	10595012	10590312	16" Pair	10601516	10601116
14" Pair	10595014	10590314	18" Pair	10601518	10601118
16" Pair	10595016	10590316	20" Pair	10601520	10601120
18" Pair	10595018	10590318	22" Pair	10601522	10601122
20" Pair	10595020	10590320	24" Pair	10601524	10601124
22" Pair	10595022	10590322	24/36" Pair*	10601525	10601137
24" Pair	10595024	10590324	26" Pair	10601526	10601126
24/36" Pair*	10595025	10590337	28" Pair	10601528	10601128
26" Pair	10595026	10590326	30" Pair	10601530	10601130
28" Pair	10595028	10590328	32" Pair	10601532	10601132
30" Pair	10595030	10590330	34" Pair	10601534	10601134
32" Pair	10595032	10590332	36" Pair	10601536	10601136
34" Pair	10595034	10590334	38" Pair	10601538	10601138
36" Pair	10595036	10590336	40" Pair	10601540	10601140
40" Pair	10595040	10590340	42" Pair	10601542	10601142
			44" Pair	10601544	10601144
			46" Pair	10601546	10601146
			48" Pair	10601548	10601148
* Glass height of top sash 24". Glass height of bottom sash 36". (all clutches black)			* Glass height of top sash 24". Glass height of bottom sash 36". (all clutches blue)		

SUPER HEAVY DUTY (BROWN CLUTCH)

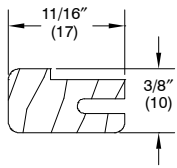
Glass Height (one sash)	Part Numbers White	Part Numbers Beige
20" Pair	10606120	10606020
22	10606122	10606022
24	10606124	10606024
24/36	10606125	10606037
26	10606126	10606026
38	10606128	10606028
30	10606130	10606030
32	10606132	10606032
34	10606134	10606034
36	10606136	10606036
38	10606138	10606038
40	10606140	10606040
42	10606142	10606042
44	10606144	10606044
46	10606146	10606046
48	10606148	10606048
* Glass height of top sash 24". Glass height of bottom sash 36". (all clutches brown)		

TO ORDER REPLACEMENT WOOD PARTS

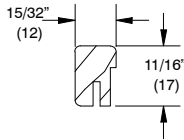
When ordering replacement wood parts specify:

1. profile number;
2. call number or rough opening;
3. length;
4. finish.

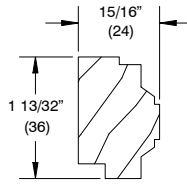
	Ultimate Wood	Ultimate
3/8 Tilt Pac Part Stop (optional)	W10495	W10495
Parting Stop	W7082	W7082
Stationary Sash Filler	W7090	



W10495



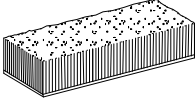
W7082



W7090

When ordering replacement weather strip specify:

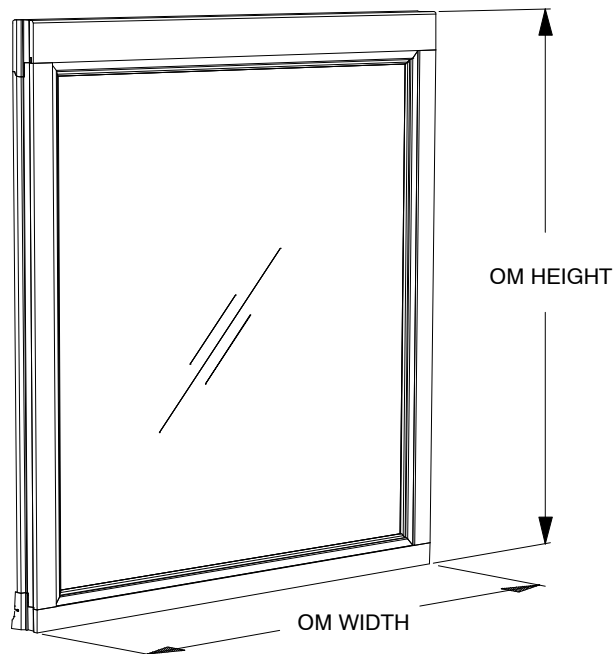
1. quantity;
2. color;
3. part number;
4. description.

ILLUSTRATION <i>NOT TO SCALE</i>	DESCRIPTION	LENGTH	PART NUMBER
	Bulb Weather Strip, Bottom Rail V192 Color: Beige	84" (2134)	15900058
	Dual Seal Weather Strip, Check Rail V116 Color: White	84" (2134)	15828400
	Hinged Leaf Weather Strip, Parting Stop V245 Color: White	84" (2134)	15818400
	Pile Weather Strip (Dust Fuzzy), Jamb Hardware 3/8"x1 1/4" x 1/8" Color: White		10600000
	Pile Weather Strip, Top Blind Stop and Sash Stiles M 730 3/16" x 5/32" Ultimate units only Color: Gray	Specify length	15607560

ORDERING REPLACEMENT SASH FOR TILT PAC

When ordering replacement sash specify:

1. which sash is being replaced – top, bottom or pair;
2. size;
 - a. top or bottom (call number or OM of sash)
 - b. pair (call number or sash opening – indicate if unequal sash)
3. glazing;
 - a. Ultimate Wood (SDL ready glazing profile only)
 - b. Ultimate (standard glazing)
4. finish;
5. sill bevel if other than standard 14°.



Exterior View
(top sash shown)