

# STORMPLUS

## Table of Contents

	<b>PAGE</b>
History .....	2
Casemaster .....	4
Awning .....	8
Ultimate Casement .....	9
Ultimate Double Hung .....	10
Ultimate Double Hung Next Generation .....	12
Ultimate Inswing French Door .....	13
Ultimate Outswing French Door .....	14
Sliding French Door .....	17
Installation Accessories .....	20

### **ATTENTION:**

- Specification and technical data are subject to change without notice.
- Numbers listed in parentheses ( ) are metric equivalents in millimeters rounded to the nearest whole number.

DATE	PRODUCT	DESCRIPTION OF CHANGE / NEW PRODUCT
4/30/2001	SP Dade	Impact resistant Clad Ultimate Outswing French Door added to Storm Plus Dade.
8/19/2002	SP NY	Introduced Wood Ultimate Double Hung to Storm Plus NY.
11/12/2002	SP NY	Marvin now offers Wood and Clad Ultimate Double Hung, Wood Ultimate Double Hung Picture/Transom, and Wood Direct Glaze units. (Product bulletin #307)
12/9/2002	SP NY	StormPlus NY expands product lines to include Wood and Clad Ultimate Outswing French Doors, Clad Ultimate Double Hung Transom, Clad Direct Glaze Rectangles/Polygons/Round Tops, and Wood and Clad Casemaster operators. (Product bulletin #309)
12/30/2002	SP NY	StormPlus NY expands product lines to include Wood and Clad Ultimate Inswing French Doors, Wood and Clad Sliding French Door, Wood and Clad Awning operators, Wood and Clad Casemaster/Awning stationary and picture units, Clad Ultimate Double Hung Picture units. (Product bulletin #309)
7/7/2003	All	Naming convention changed: Storm Plus NY is now Storm Plus IZ2, StormPlus Dade is now Storm Plus IZ4, StormPlus HP name remains the same.
8/18/2003	IZ3	Introduction of Storm Plus IZ3 products. Products include wood and clad Casemasters and Awnings, Clad Direct glaze Polygons, Rectangles and Round Tops, and Clad Ultimate Outswing French Doors in stationary or one and two panel operating configurations. (Product bulletin #325)
9/29/2003	IZ3	Marvin Stormplus IZ3 line expands to include RTs/Polys/Sidelites/more. (Product bulletin #328)
10/24/2003	HP SFD	Storm Plus HP Clad Sliding French Door retired. (Product bulletin #327)
10/27/2003	IZ3	Expanded IZ3 to include Clad and Wood Ultimate Double Hung/Round Top/Poly/Transom, Clad an Ultimate Outswing French Door, Clad and Wood Sliding French Door. (Product bulletin #330)
11/10/2003	IZ3	Expanded IZ3 to include Clad and Wood Ultimate Double Hung Picture/Round Top/Polygon, Clad and Wood UIFD Sidelite/Transom (Product bulletin #330)
9/2/2004	UDH IZ3	UDH 1" wide mullions offered for side-by-side assemblies, wood or clad. Factory applied or field installed.
2/14/2005	CM IZ4	Started producing CCM IZ4; added 3rd lock to units taller than CN48 in order to receive higher design pressures. (Product bulletin #360)
3/14/2005	CM IZ3	Expanded CM IZ3 size offering to CN 3672 Units wider than CN28 will auto. receive a sash limit device.
6/27/2005	Doors, IZ3	Introduced 2 1/4" Panel doors for IZ3. 2 1/4" Door expands configurations, features and options.
9/6/2005	Doors, IZ4	Introduced 2 1/4" Panel doors for IZ4.
7/24/2006	WUDH IZ2	Discontinued WUDH Picture and Transom IZ2 units. (Incorporated into IZ3 line)
10/6/2006	IZ2 DG	Discontinued WDG Rectangle, Polygon, & RT IZ2 units. (Incorporated into IZ3 line)
11/14/2006	CUDH IZ3	Eliminated screws through interior stops, added brackets to top rail Vinyl partstop w/s is cut into short pieces to fit between brackets.
	CUDH IZ2	Discontinued CUDHP IZ2 units.
3/16/2007	Doors, IZ4	Introduced Mahogany WUOFD IZ4.
3/26/2007	CM IZ2 and IZ3	New Hinge Limiter option, allows unit to open 75 degrees to meet egress. Old limiter still available, 20 degree.
5/23/2007	CUOFD IZ4	IZ4 glass now has the SGP interlayer. LVL stiles and the current IZ3 sill backer plate will replace FRP/locking stiles and "C" shaped sill backer plate.

DATE	PRODUCT	DESCRIPTION OF CHANGE / NEW PRODUCT
03/23/2009	CM IZ4	CCM and CAWN IZ4 changed from cam lock style to sequential locking system.
07/27/2009	UCA	CUCA and WUCA IZ3 released.
04/26/2010	UAWN	CUAWN and WUAWN IZ3 released.
10/25/2010	Doors, IZ2	All IZ2 doors now obsolete.
04/25/2011	All	White painted interior finish option introduced for all product.
01/23/2012	Clad Ultimate Double Hung	Redesign of the Clad Ultimate Double Hung IZ3. Added new IZ3 tilt pin, sill bracket, top and bottom sash interlock and a new checkrail profile.
01/30/2012	Clad Ultimate Double Hung	Clad Ultimate Double Hung IZ2 was discontinued.
04/30/2012	Wood Ultimate Double Hung	Wood Ultimate Double Hung IZ2 was discontinued and IZ3 redesigned with the same modifications as CUDH
2012	Ultimate Outswing French Door, IZ4	2012-07-30 Added Panel Drip Kit for IZ4 Ultimate Outswing French Door.
	All	2012-12-17 Clear interior finish option introduced for all products.
2013	All	04/29/2013 Introduced interior stain options. Stain colors are Wheat, Honey, Leather, Hazelnut, Cabernet and Espresso.
10/28/2013	CUPCA	CUPCA IZ3 released.
2014	Ultimate Outswing French Door, IZ4	8/25/2014 Panel drip (A2408) will now match clad color. Screws will match standard clad colors. For Custom Color Clad, screws will be stainless steel.
01/21/15	CUDH-NG, RT CUDH-NG	Clad Ultimate Double Hung Next Gen and Clad Roundtop Ultimate Double Hung Next Gen IZ3 released.
06/29/15	CM/UCA/OFD & CDG	Casemaster IZ4 SG products obsolete. Replaced with UCA IG product for all IZ4. All products changed from SG to IG.
08/24/15	CSFD	Clad Sliding French Door OXXO IZ3/HP released and Clad Sliding French Door OX and XO HP released.
10/26/15	CSFD	Clad Sliding French Door 3 panel IZ3/HP released.
10/26/15	CMSD	Clad Multi Slide Door IZ3/HP released
10/30/2017	CM IZ	Started discontinuation of CM IZ parts

ILLUSTRATION NOT TO SCALE	DESCRIPTION	COLOR	PART NO.
	<p><b>Snubber, Concealed</b> Wood Casemaster 2 per package <i>Includes:</i> 2 – Snubbers 10899110 2 – #7x5/8" Phillips flat head wood screws (11800736) 2 – #8x1" Phillips flat head wood screws (11800805)</p>		11873197
	<p><b>Snubber, Concealed</b> Clad Casemaster 2 per package <i>Includes:</i> 2 – Snubbers 10899110 2 – #7x1/2" Phillips flat head screws (11800753) 2 – #8x1" Phillips flat head wood screws (11800805)</p>		11873295
	<p><b>Cam Lock</b> WCM IZ4 <i>Includes:</i> 1 – Cam Lock 2 – #8 x 1 1/2" Phillips flat head self-tapping screws           BZ (11881117)           WH (11881118)           TP (11881116)</p>	BZ WH TP	10814904 10814905 10814907
 <i>Note: Left hand shown</i>	<p><b>Hinge Limiter</b></p>	LH RH	11862602 11862601

ILLUSTRATION NOT TO SCALE	DESCRIPTION	OPER. COLOR	PART NO.
	<p><b>RTCM Sash Limiter</b> 20 Degree IZ3</p>	<p>E-Guard  Corr. Resistant</p>	<p>10830707  10830708</p>
 <p>LH Shown</p>	<p><b>Sequential Lock, Primary</b> Primary cam included IZ2, IZ3, IZ4 <i>Includes:</i> 1 – Primary sequential lock with primary cam 3 – #8x1" Phillips pan head wood screws (11808100)</p>	<p>LH WH RH WH LH BZ RH BZ LH TP RH TP</p>	<p>10816110 10816111 10816112 10816113 10816114 10816115</p>

**CURRENT REPLACEMENT WOOD AND VINYL PARTS**

StormPlus	Clad	Wood
Jamb Side Stop, IZ4	W8460	W8460
Jamb Side Stop, IZ2, IZ3	V1162	V1162
RT/Poly Stat Sash Stop, IZ4	W8462	W8462
Jamb Frame Filler, IZ4	W7686	
HJ Filler, IZ4	W7676	
Hardware Cover	W8459	W8459
HJ Stop, Operator	W8461	W8461
Sill Cover, Stat	W8723	W8723
HJ Stop, Stat	W7001	W7001
Jamb Stop, Stat	W7015	W7015

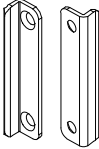
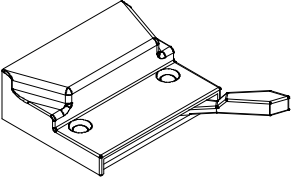
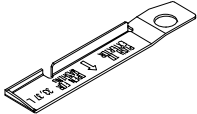
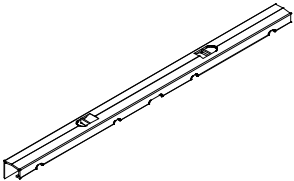
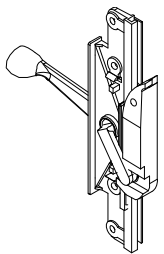
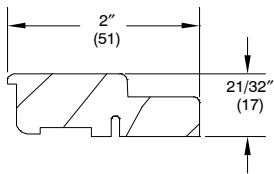
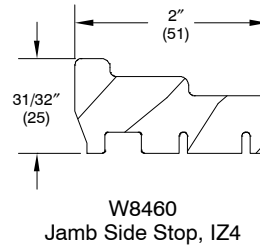

W8462  
CMRT/Poly Stat  
Sash Stop, IZ4

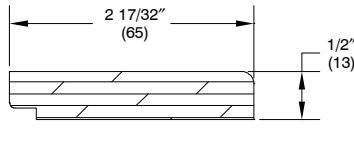

W7676  
HJ Filler, IZ4

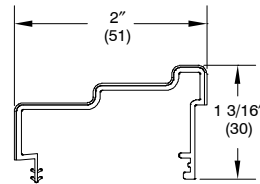

V1162  
Jamb Side Stop, IZ2, IZ3

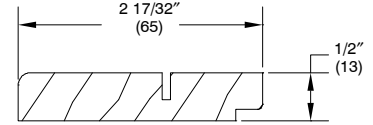

W7686  
Jamb Frame Filler, IZ4

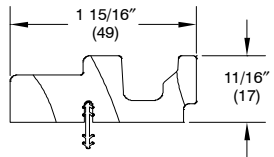

W8461  
Oper. Head Jamb Stop

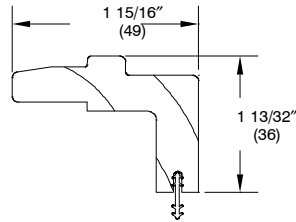

W8459  
Oper. Hardware Cover

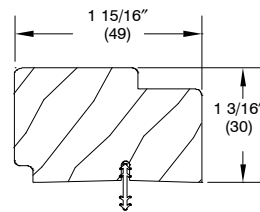

W8723  
Stat. Hardware Cover

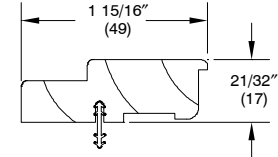

W7001  
HJ Stop, Stat

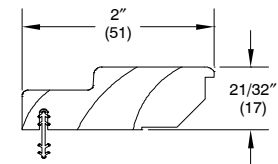

W7015  
Stat. Side Jamb Stop

### ORDERING REPLACEMENT SCREENS FOR CASEMASTER

Screens are available with aluminum or wood surround and charcoal colored fiberglass 18 x 16 screen mesh. Aluminum mesh is available as an option in black, charcoal, bright aluminum, or bright bronze. Determine the outside measurement of the existing screen. Find the sizes that correspond to the width and height indicated on the following charts. Aluminum surrounds are available in satin taupe, bronze, white, brown and pebble gray.

When ordering replacement screen specify:

1. size; – If there is no existing screen from which to obtain the OM of the screen, determine the size of the screen by using measurement conversion charts below. The daylight opening is the measurement of the visible glass.
2. color;
3. mesh type (if other than standard)
4. year or fastener type (if other than current).

Note: Gold tone screen surround is no longer available.

<b>StormPlus IZ4</b> <b>Casemaster and Awning Screen Sizes</b> <b>Aluminum and Wood Screens</b>  <b>Daylight Opening to OM of Screen</b> Daylight Width + 2 3/4" = OM Width of Screen Daylight Height + 2 7/32" = OM Height of Screen			
<b>Width</b>		<b>Height</b>	
Size	OM Width	Size	OM Height
CN 16	12 25/64"	CN 20	15 1/32"
CN 20	16 25/64"	CN 24	19 1/32"
CN 24	20 25/64"	CN 28	23 1/32"
CN 28	24 25/64"	CN 32	27 1/32"
CN 32	28 25/64"	CN 36	31 1/32"
CN 36	32 25/64"	CN 40	35 1/32"
CN 40	36 25/64"	CN 48	43 1/32"
CN 48	44 25/64"	CN 56	51 1/32"
CN 56	52 25/64"	CN 60	55 1/32"
		CN 64	59 1/32"
		CN 72	67 1/32"

Note: Screens produced after April 2003 utilize plunger and spring assemblies. Screens produced prior to April 2003 utilize bayonet latches.

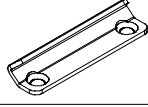
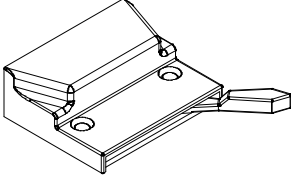
ILLUSTRATION <i>NOT TO SCALE</i>	DESCRIPTION	OPER COLOR	PART NO.
	<b>CM Snubber</b>		10899110
	<b>Cam Lock</b> WAWN IZ4	BZ WH TP	10814904 10814905 10814907
 <i>Note: Left hand shown</i>	<b>Hinge Limiter</b>	LH RH	11040395 11040394

**CURRENT REPLACEMENT WOOD AND VINYL PARTS**

StormPlus	Clad	Wood
Jamb Side Stop, IZ4	W8460	W8460
Jamb Side Stop, IZ2, IZ3	V1162	V1162
Stat Sash Stop, IZ4	W8462	W8462
Jamb Frame Filler, IZ4	W7686	
HJ Filler, IZ4	W7676	

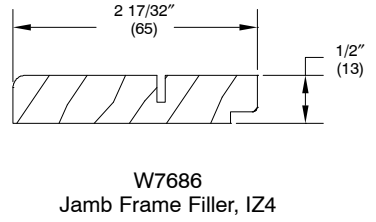
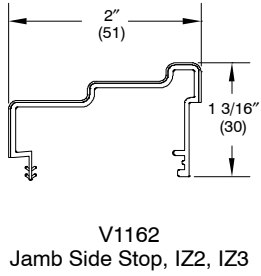
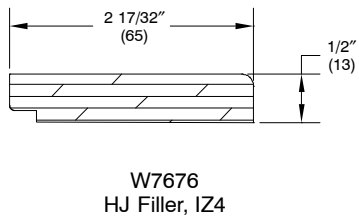
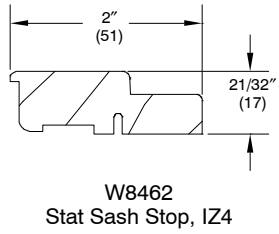
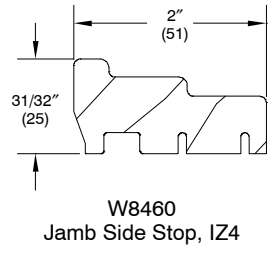



<b>ILLUSTRATION</b> <i>NOT TO SCALE</i>	<b>DESCRIPTION</b>	<b>OPER. COLOR</b>	<b>PART NO.</b>
	<b>Impact Tie Bar Hold Down</b> IZ3 / IZ4 <i>Uses:</i> 1 – #8– 1 1/4" pan head screw (11800557)		10816392

ILLUSTRATION NOT TO SCALE	DESCRIPTION	OPER.- COLOR	PART NO.
	<p><b>Tilt Latch Assembly</b> IZ3 – Clad <i>Includes:</i> 1 – fastener 11806136 1 – fastener 11800519</p>	<p>LH RH</p>	<p>10500950 10500951</p>
	<p><b>Tilt Latch Assembly</b> IZ3 – Wood <i>Includes:</i> 1 – fastener 11806136 1 – fastener 11800519</p>	<p>LH RH</p>	<p>10500704 10500705</p>
	<p><b>Tilt Pin</b> IZ3 <i>Includes:</i> 1 – fastener 11800801 1 – fastener 11881122</p>	<p>SS</p>	<p>10500703</p>
	<p><b>Interlock, Top Sash</b> IZ3 <i>Includes:</i> 3 – fasteners 11806136</p>	<p>BG</p>	<p>10500701</p>
	<p><b>Interlock, Bottom Sash</b> IZ3 <i>Includes:</i> 3 – fasteners 11806112</p>	<p>SS</p>	<p>10500709</p>
	<p><b>Sill Bracket</b> IZ3 <i>Includes:</i> 2 – fasteners (BG) 11800763 or (WH) 11800764</p>	<p>BG WH</p>	<p>11841103 11841104</p>
	<p><b>Sash Stay</b> IZ3 Pre 01–23–2012 Clad IZ3 Pre 04–30–2012 Wood For Field Service only</p>	<p>LH BG LHWH  RH BG RH WH</p>	<p>10815280 10815282  10815281 10815283</p>
	<p><b>Sill Bracket, Picture</b> IZ3</p>		<p>10500526</p>

ILLUSTRATION NOT TO SCALE	DESCRIPTION	OPER.- COLOR	PART NO.
	<p><b>Storm Clips Clasp</b>                      IZ2                      For Field Service only  <i>Includes:</i>                      (2) #7-16 x 7/8" Type A-17 Full Thread Screws                      WH 10840019                      BZ 11800779,                      AB 11800788, ORBZ 11800794                      SN 11800796, PC 11800790                      BC 11800789</p>	<p>WH                      BZ                      AB                      ORBZ                      SC                      SN                      PC</p>	<p>10500691                      10500690                      10500693                      10500697                      10500694                      10500698                      10500695</p>
	<p><b>Storm Clips Keeper</b>                      IZ2                      For Field Service only  <i>Includes:</i>                      (2) #7-16 x 7/8" Type A-17 Full Thread Screws                      WH 10840019                      BZ 11800779,                      AB 11800788, ORBZ 11800794                      SN 11800796, PC 11800790                      BC 11800789</p>	<p>WH                      BZ                      AB                      ORBZ                      SC                      SN                      PC</p>	<p>10500607                      10500606                      10500609                      10500613                      10500610                      10500614                      10500611</p>

ILLUSTRATION <i>NOT TO SCALE</i>	DESCRIPTION	OPER.- COLOR	PART NO.
	<b>Sill Reinforcement, IZ3</b> <i>A2766 – Lineal 144" (3658)</i> <i>Uses:</i> <i>#8x1" Phillips flathead screw</i>	<b>Lineal</b> WH AL BK	18865299 18865399 18865499
	<b>Bracket, Sill, CUDHP–NG IZ3</b> <i>Uses:</i> <i>2 – #7x3/4" Phillips flathead wood screw</i>	SS	10500764

### CURRENT REPLACEMENT WOOD AND VINYL PARTS

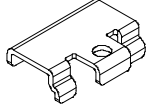
StormPlus	Clad
Sill Liner, IZ3	W12392

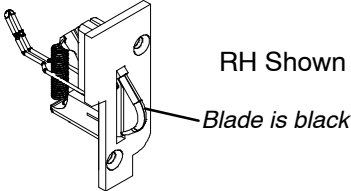
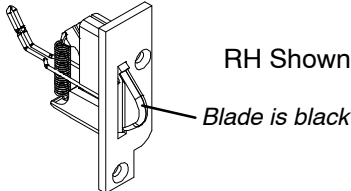
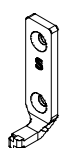
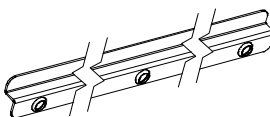
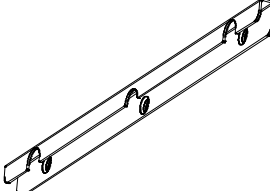
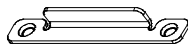
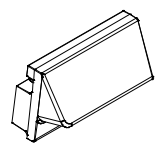
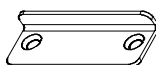

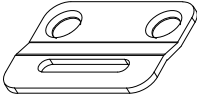
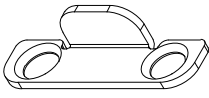
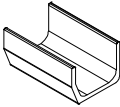
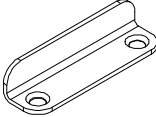
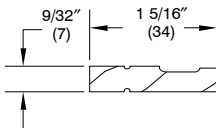
W12392– Sill Liner, IZ3  
CUDH–NG

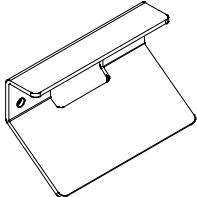
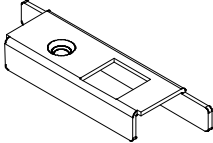
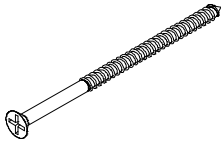
ILLUSTRATION NOT TO SCALE	DESCRIPTION	OPER. COLOR	PART NO.
	<b>Sill Strike Backer Plate</b> IZ2 and IZ3		10148009
	<b>Stile End Plate</b> IZ2, IZ3	LH RH	10148008 10148007
	<b>#8 – 15 x 3" 2/3 Thread SS Screw</b> IZ2, IZ3,		11800858

### CURRENT REPLACEMENT WOOD AND VINYL PARTS

StormPlus	Wood and Clad
Sill Liner, IZ3	W8661
Glazing Stop, IZ3	W9483

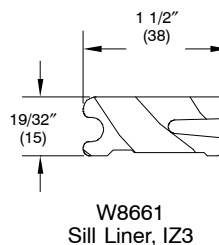
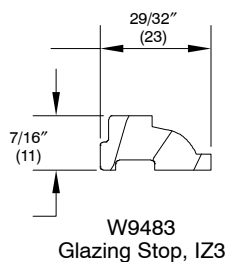







<b>ILLUSTRATION</b> <i>NOT TO SCALE</i>	<b>DESCRIPTION</b>	<b>OPER./ COLOR</b>	<b>PART NUMBER</b>
	<b>Sill Strike Backer Plate</b> Outswing Doors IZ2, IZ3, IZ4		10148006
	<b>Stile End Plate</b> IZ2, IZ3, IZ4	LH RH	10148008 10148007
	<b>Shoot Bolt Guide</b> IZ4 Used with shoot bolt guide reinforcement at bottom of panel		05700066
	<b>Shoot Bolt Guide Reinforcement</b> IZ4 Used with shoot bolt guide at bottom of panel		05700065
	<b>Mull Reinforcement Plate</b> IZ4		02070302
	<b>Shoot Bolt Guide</b> Used from 2001–2007 IZ4 Used on inactive panels		10815188
	<b>Mull Casing Base Connector</b> Used from 2004–2007 IZ4		11860080
	<b>#8 – 15x3" 2/3 Thread SS Screw</b> IZ2, IZ3, IZ4 – Used at top of panel through stile end plate IZ4 – Used at bottom of panel through shoot bolt reinforcement		11800858
	<b>#8x3" panhead SS Screw</b> IZ2, IZ3 – Used through bottom shoot bolt guide into stile.		11882350
	<b>Clad Mull Casing End Plug</b> IZ4 <i>(Clad Doors Only)</i>	LH BG RH BG LH BZ RH BZ	10500255 10500254 10500267 10500266
	<b>Bottom Shoot Bolt Assembly, IZ4</b> <i>Includes:</i> 1 – Spacer 1 – Hex Nut 1 – Shoot Bolt 1 – Lock Rod		18900450
	<b>Bulb Weather Strip, V192</b> IZ4 192"	BG BK	15900118 15900117

ILLUSTRATION NOT TO SCALE	DESCRIPTION	OPER./ COLOR	PART NUMBER
	<b>Header Reinforcement Bracket Assembly IZ4</b> <i>Includes:</i> 1 – Plate 1 – Bracket 2 – #8 x 3/8" Machine Screws (02058014) 2 – #8 x 1" Full Thread Screws (11800645)		21505000
	<b>Head Jamb Strike Plate IZ4</b>	SS	05700082
	<b>Shim, Head Jamb Strike IZ4</b>		11100251
	<b>Stationary Bracket</b> Jamb / Head Jamb IZ4		11100212
	<b>#10 – 12 x 3" Phillips Flathead Screw</b> For Head Jamb Strike OFD IZ4		02056011
	<b>Pkg, Panel Drip – COFD IZ4</b> July 30, 2012 – Present <i>Includes:</i> A2408 Panel Drip (For Custom Color match see Profile section), Foam Tape #6 x 1/4" flat head screws		1-6 Beige 11100272 2-0 Beige 11100273 2-6 Beige 11100274 2-8 Beige 11100275 3-0 Beige 11100276  1-6 Bronze 11100282 2-0 Bronze 11100283 2-6 Bronze 11100284 2-8 Bronze 11100285 3-0 Bronze 11100286
<b>Pkg, Panel Drip – WOFD IZ4</b> July 30, 2012 – Present <i>Includes:</i> A2408 Panel Drip (For Custom Color match see Profile section), Foam Tape #6 x 1 1/4" flat head screws		1-6 Beige 11100277 2-0 Beige 11100278 2-6 Beige 11100279 2-8 Beige 11100280 3-0 Beige 11100281  1-6 Bronze 11100287 2-0 Bronze 11100288 2-6 Bronze 11100289 2-8 Bronze 11100290 3-0 Bronze 11100291	

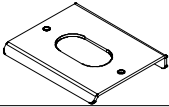
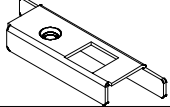
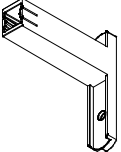
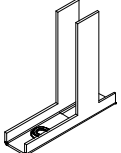
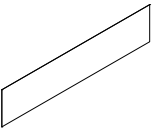
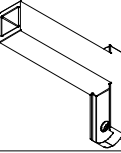
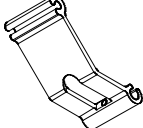
**CURRENT REPLACEMENT ALUMINUM, WOOD AND VINYL PARTS**

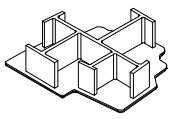
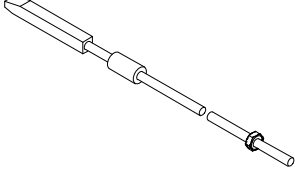
StormPlus	Wood and Clad
Wide Head Jamb Stop, IZ4	W6000
Oak Sill Cover, IZ3, IZ4	W9510
Glazing Stop, IZ4	W4019
Glazing Stop, IZ3	W9483
Jamb Part Stop, Stat., IZ4	W9475
Astragal, IZ4	W1091
Roller Track	V1017
Panel Drip (Active and Stationary Panels)	A2408

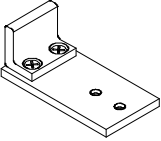
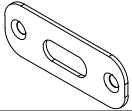
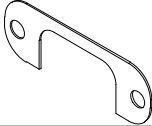
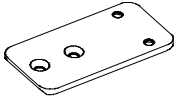

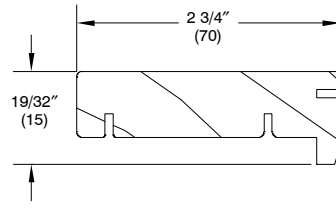
W6000  
Wide Head Jamb Stop, IZ4

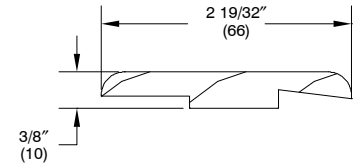

W9510  
Oak Sill Cover, IZ3, IZ4

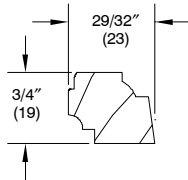

W4019  
Glazing Stop, IZ4

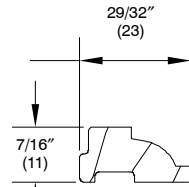

W9483  
Glazing Stop, IZ3

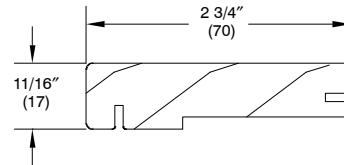

W9475  
Jamb Part Stop, Stat IZ4

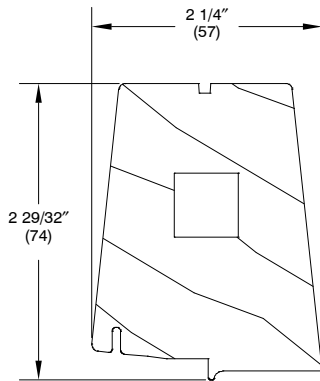

W1091  
Astragal, IZ4  
Used 2004–2007

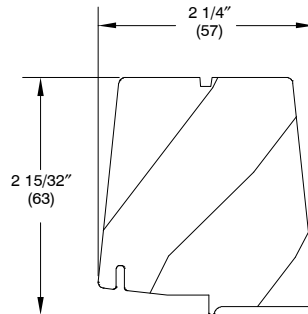

W9531  
Mull Base, IZ4



A2408 – Panel Drip



A771  
Mull Casing Base, IZ4

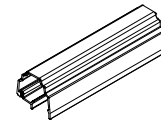

A772  
Astragal Cladding, IZ4



ILLUSTRATION NOT TO SCALE	DESCRIPTION	OPER. COLOR	PART NO.
	<b>#8 – 15x3” 2/3 Thread SS Screw</b> IZ2, IZ3 – Used through lock, keeper and jamb into the structure at installation		11800858
	<b>#10 – 13x3” 2/3 Thread SS Screw</b> IZ3 – Used through oak sill liner into structure at installation		11801017
	<b>#8 – 18 x 5/8” Type A/TEK–2 Full Thread</b> IZ3 Wood screw Used to attach sill brackets to sill	MF	11808502
	<b>#8 – 18 x 5/8” Type A/TEK–2 Full Thread</b> IZ3 Pan head screw Used to attach the sill cover to the sill	BG BZ	11800543 11800544
	<b>Cover, Sill OXXO A2843</b>  96” long (2438)	BZ CS	18716000 18716005
	<b>Bracket, Sill</b>	MF	11100252

ILLUSTRATION NOT TO SCALE	DESCRIPTION	OPER. COLOR	PART NO.
	<p><b>Astragal, CSFD OXXO A2847</b></p> <p>IZ3/HP 96" long (2438)</p>	<p>SW BZ PB BN EB EG AR CS CO CU WB DB SA HS CG CC FV MSL MCP CCC MF</p>	<p>18716200 18716210 18716205 18716215 18716220 18716225 18716230 18716235 18716240 18716245 18716250 18716255 18716260 18716265 18716270 18716275 18716280 18716285 18716290 18716295 18716299</p>
	<p><b>Mull Casing Cover Clad A775</b></p> <p>To be used as the astragal clip/cap/cover for OXXO IZ3/HP</p> <p>192" long (4877)</p>	<p>SW BZ PB BN EB EG AR CS CO CU WB DB SA HS CG CC FV MSL MCP CCC MF</p>	<p>18709534 18709520 18709530 18709518 18709526 18709528 18709500 18709524 18709522 18709508 18709536 18709510 18709532 18709514 18709506 18709504 18709512 18709539 18709540 18450122 18709539</p>

**CURRENT REPLACEMENT WOOD AND VINYL PARTS**

StormPlus	Wood	Clad
Glazing Stop, IZ3	W9483	W9483
Sill Liner, IZ2, IZ3	W8534	W8534

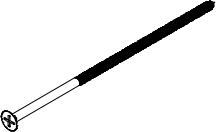
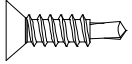
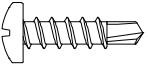
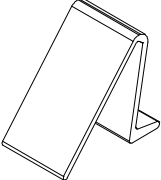
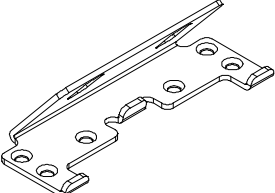
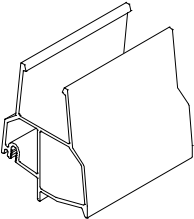
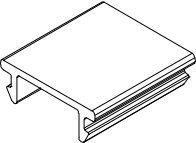
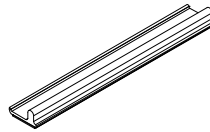
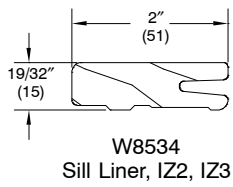

V1017  
Roller Track

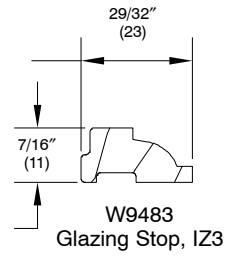
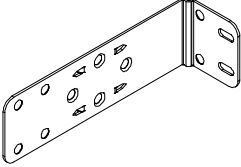
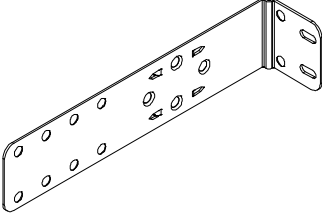

ILLUSTRATION <i>NOT TO SCALE</i>	DESCRIPTION	LENGTH	PART NUMBER
	<b>Structural Bracket, 4 9/16"</b> <i>UDH, UOFD</i>	Each	11860036
	<b>Structural Bracket, 6 9/16"</b> <i>UDH, UOFD</i>	Each	11860032