

ULTIMATE AND ULTIMATE WOOD SLIDING PATIO DOOR ULTIMATE AND ULTIMATE WOOD TRIMLINE PATIO DOOR DISC LA PRE 2003

Table of Contents

	PAGE
History – Ultimate Trimline Patio Door DISC LA PRE 2003	2
History – Ultimate and Ultimate Wood Sliding Patio Door	3
Part Identification	
Part Identification – Ultimate Wood Sliding Patio Door – OX or XO	4
Part Identification – Ultimate Wood Sliding Patio Door Stationary	5
Part Identification – Ultimate Wood Sliding Patio Door – XOO, OXO or OXXO Jamb Detail	6
Part Identification – Ultimate Sliding Patio Door – OX or XO	7
Part Identification – Ultimate Sliding Patio Door Stationary	8
Part Identification – Ultimate Sliding Patio Door – XOO, OXO or OXXO Jamb Detail	9
Parts	
Hardware and Miscellaneous	10
Parts for Lock Status Sensor	16
Wood Parts	17
Vinyl and Fiberglass Parts	18
Aluminum Parts	19
Panel Replacement	20
Weather Strip	21
Discontinued Parts Limited Availability (LA) – Ultimate and Ultimate Wood Sliding Patio Door	
Discontinued Parts – Limited Availability (LA)	23
Discontinued Vinyl Parts – Limited Availability (LA)	24
Discontinued Weather Strip – Limited Availability (LA)	25
Discontinued Parts No Availability (NA) – Ultimate and Ultimate Wood Sliding Patio Door	
Discontinued Parts – No Availability (NA)	26
Discontinued Wood Parts – No Availability (NA)	27
Discontinued Weather Strip – No Availability (NA)	28
Discontinued Parts Limited Availability (LA) – Ultimate Trimline Patio Door DISC LA PRE 2003	
Discontinued Parts – Limited Availability (LA)	29
Discontinued Vinyl or Fiberglass Parts – Limited Availability (LA)	31
Discontinued Aluminum Parts – Limited Availability (LA)	32
Discontinued Wood Parts – Limited Availability (LA)	33
Discontinued Weather Strip – Limited Availability (LA)	34
Discontinued Panel Replacement – Ultimate Trimline Patio Door DISC LA PRE 2003	35
Discontinued Parts No Availability (NA) – Ultimate Trimline Patio Door DISC LA PRE 2003	
Discontinued Parts – No Availability (NA)	36
Discontinued Vinyl Parts – No Availability (NA)	37
Discontinued Weather Strip – Limited Availability (LA)	38
Screens – See Door Screen Chapter	

ATTENTION:

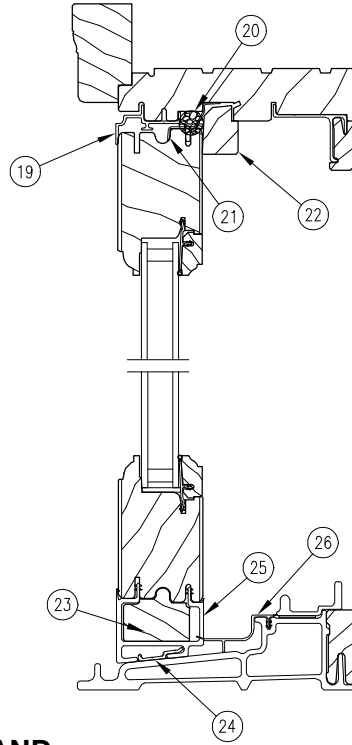
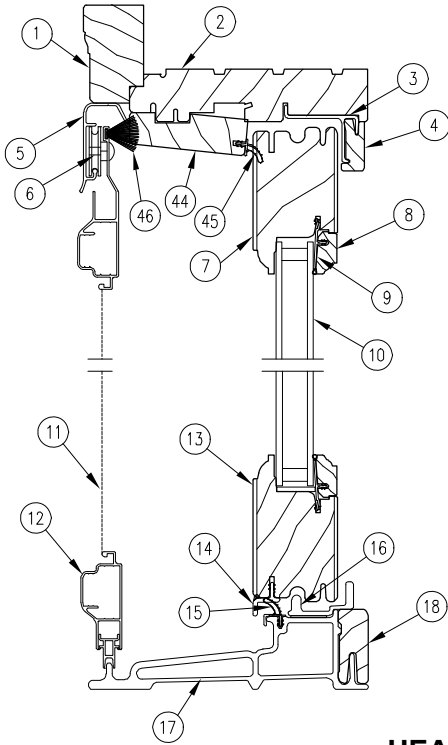
- Specification and technical data are subject to change without notice.
- Numbers listed in parentheses () are metric equivalents in millimeters rounded to the nearest whole number.

PRODUCED	UNIT TYPE	FEATURES OR CHANGES	DISCONTINUED
1988	Retro Patio Door	Unit features 3/4" insulating glass, mortise style locking system, exterior (non-keyed) handle and wood interior handle. All models including three panel doors feature continuous header and sill. Bare wood exterior. Bronze exterior (non keyed) handle. Lexan sill with wood sill core.	Present 1989 1991 1991
1989	Retro Patio Door	Primed exterior standard.	1998
1990	Retro Patio Door	Unit features extruded aluminum exterior, 3/4" insulating glass, glazing cap, mortise style locking system, exterior (non-keyed) handle and wood interior handle. All models including three panel doors feature continuous header and sill. Bronze exterior (non-keyed) handle. Lexan sill with wood sill core.	Present 1991 1991
1991	Retro Patio Door	External component parts changed to beige including exterior (non-keyed) handle. Sill redesigned from wood sill core to a composite sill core (this resulted in panel size change also affecting grilles, screens and glass sizes).	Present 1995
1992	Retro Patio Door	Retro CN 6-8 height was changed to a CN 6-5 height. A full size CN 6-8 height door was added to product line. Term "Retro" changed to Trimline.	Present
1992	Ultimate and Ultimate Wood Trimline Patio Door DISC LA PRE 2003	Simulated divided lite option introduced.	Present
1993	Ultimate and Ultimate Wood Trimline Patio Door DISC LA PRE 2003	Simulated divided lite and factory installed brick mould casing introduced.	Present
1995	Ultimate and Ultimate Wood Trimline Patio Door DISC LA PRE 2003	Sill redesigned from Lexan cover with a composite sill core to a one piece composite sill (no panel size change). Added roller track and cover, redesigned leveling block and added leveling block filler, replaced dust block assembly with hydroseal and redesigned panel drip. Panel drip replaced sill weather strip. Redesigned interlocks (and added interlock end caps with gaskets), redesigned operating jamb parting stop weather strip.	Present
1998	Ultimate and Ultimate Wood Trimline Patio Door DISC LA PRE 2003	1/98 Interlocks (V471,472,& 747) replaced with V714 & V715. Hydroseal and end cap replaced with dust block, dust block support, and gasket. Operator jamb weather strip (V777) replaced by V735. 5/98 Sill Roller track (V769) replaced with V786. Operator panel drip/weather strip (V760) replaced with V800 panel drip and V791 sill weather strip. Sill door stop (W7287) replaced with V807. 8/98 Added 8-0 height to standard sizes, also available in special sizes. Multi-point mortise lock standard. Performance ratings now DP 30 (up to 6/8), DP 20 (up to 8/0). Ultimate Wood available with interior sill and/or single glazed with EP. Prime exterior no longer standard, now optional. The enhancements and expanded product offerings to coincide with retirement of the Safe-T-Plus patio door.	Present Present Present
2002	Ultimate and Ultimate Wood Trimline Patio Door DISC LA PRE 2003	3/02 Stone White becomes a standard color. Arctic White transitions to a select color. 8/0 height decreases by 2 1/2 inches.	Present
2003	Ultimate and Ultimate Wood Trimline Patio Door DISC LA PRE 2003	11/03/03 Discontinued	Present

PRODUCED	UNIT TYPE	FEATURES OR CHANGES	DISCONTINUED
2003	Ultimate and Ultimate Wood Sliding Patio Door	11/03/03 Introduced Sliding Patio Doors.	Present
2005	Ultimate and Ultimate Wood Sliding Patio Door	Introduced optional Bronze Ultrex sill with Black weather strip.	Present
2005	Ultimate and Ultimate Wood Sliding Patio Door	Added BS PVD hardware finish to door handles.	Present
2006	Ultimate and Ultimate Wood Sliding Patio Door	3/27/06 Introduced the OXXO configuration to the Sliding Patio Door line. Added SN PVD hardware finish to door handles.	Present
2006	Ultimate and Ultimate Wood Sliding Patio Door	7/24/06 Discontinued retro 6-5 height and replaced with 6-6 height. Frame OSM for 6-6 height is 3/4" taller than 6-5 doors. Frame OSM for 6-6 width is 11/16" wider (one panel), 1 3/8" wider (two panel) and 2 1/16" wider (three panel).	Present
2006	Ultimate and Ultimate Wood Sliding Patio Door	11/2006 Discontinued stationary panel top rail spacer (W8452) and replaced with a stationary bracket. Updated W7504 stationary panel head jamb cover profile.	Present
2008	Ultimate and Ultimate Wood Sliding Patio Door	6/02/2008 Introduced charcoal colored high transparency screen mesh (CH HI-TRAN) as an option on all window and door products (including combinations).	Present
2009	Ultimate and Ultimate Wood Sliding Patio Door	3/23/2009 Added LoE ³ -366™ as a standard option for all products. Added Cedro Macho as a standard option for all Ultimate products.	Present
2009	Ultimate and Ultimate Wood Sliding Patio Door	5/26/2009 Introduced the new Low Profile Sill as an option to the Sliding Patio Door and Ultimate Sliding French Door.	Present
2010	Ultimate and Ultimate Wood Sliding Patio Door	2/22/2010 Added Dark Bronze hardware finish to doors.	Present
2011	Ultimate and Ultimate Wood Sliding Patio Door	04/25/2011 Added LoE-180™ as a standard option for all products. White painted interior finish option introduced for all products.	Present
2012	Ultimate and Ultimate Wood Sliding Patio Door	10-29-2012 Interior Square Sticking/Glazing Bead option introduced. 12-17-2012 Introduced Clear interior finish option on all products.	Present
2013	Ultimate and Ultimate Wood Sliding Patio Door	4-29-2013 – Retro height 66 will be designated with an "R" in the CN. Introduced interior stain options. Stain colors are Wheat, Honey, Leather, Hazelnut, Cabernet and Espresso. 12/16/2013 – Interior Shades option introduced.	Present
2014	Ultimate and Ultimate Wood Sliding Patio Door	2/24/2014 – Introduced two Pearlescent colors – Bright Silver and Copper. Discontinued two colors – Sherwood Green and Cobalt Blue. Removed screen information and added new chapter for screen to manual.	Present
2014	Ultimate and Ultimate Wood Sliding Patio Door	8/25/2014 – Introduced Low E2 and Low E3 glass terminology.	Present
2014	Ultimate and Ultimate Wood Sliding Patio Door	10/27/2014 – Introduced Ogee as the new default interior profiles.	Present
2016	Ultimate and Ultimate Wood Sliding Patio Door	10/31/2016 Introduced 9-0 Call No heights. 10/31/2016 Obsolescence of the wood species Cedro Macho for all products.	Present
2016	Ultimate and Ultimate Wood Sliding Patio Door	11/01/2016 V1012 Panel drip is replaced by V1823.	Present
2017	Ultimate Sliding Patio Door	12/18/2017 Added availability of Lock Status Sensor.	Present
2019	Ultimate and Ultimate Wood Sliding Patio Door	04/29/2019 V1194 replaces V1138 (ECN 23234)	Present

OPERATOR PANEL

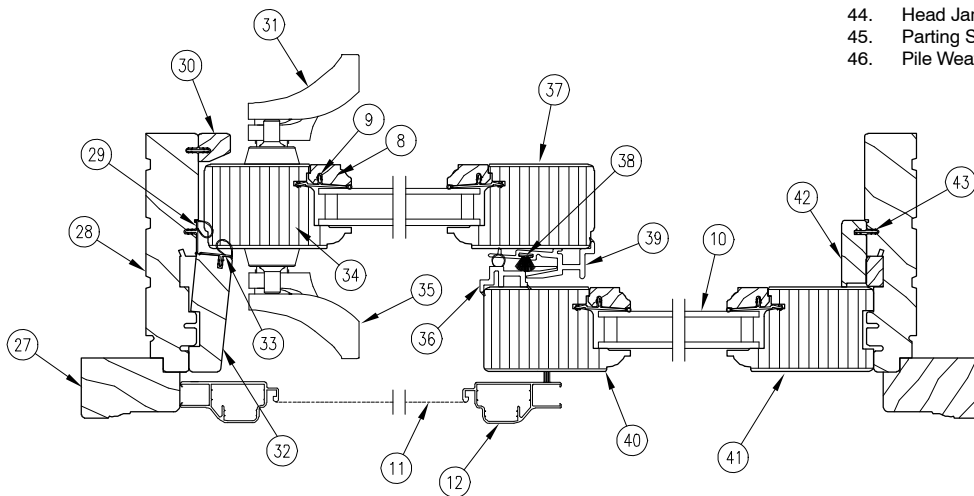
STATIONARY PANEL



1. Head Jamb Brick Mould Casing
2. Head Jamb
3. Panel Guide
4. Header Guide Cover
5. Screen Track
6. Screen Roller
7. Operator Top Rail
8. Glazing Cap
9. Glazing Bead
10. Insulated Glass
11. Screen Mesh
12. Screen Frame
13. Operator Bottom Rail
14. Panel Drip
15. Sill Weather Strip, V1194
16. Sill Roller Track
17. Ultrex Sill
18. Sill Liner
19. Stationary Head Jamb Retainer
20. Backer Rod
21. Stationary Panel Bracket
22. Stationary Panel Head Jamb Cover
23. Leveling Block Filler
24. Sill Stationary Panel Retainer
25. Leveling Block
26. Sill Condensation Cover
27. Side Jamb Brick Mould Casing
28. Side Jamb
29. Bulb Weather Strip, Side Jamb, V796
30. Interior Cover
31. Interior Handle Assembly
32. Jamb Parting Stop
33. Bulb Weather Strip, Parting Stop, V796
34. Operator Locking Style
35. Exterior Handle Assembly
36. Stationary Panel Interlock
37. Operator Meeting Style
38. Operator Panel Pile Weather Strip
39. Operator Panel Interlock
40. Stationary Meeting Stile
41. Stationary Jamb Stile
42. Stationary Jamb Cover
43. Connecting Barb
44. Head Jamb Parting Stop
45. Parting Stop Weather Strip
46. Pile Weather Strip

HEAD JAMB AND SILL DETAIL

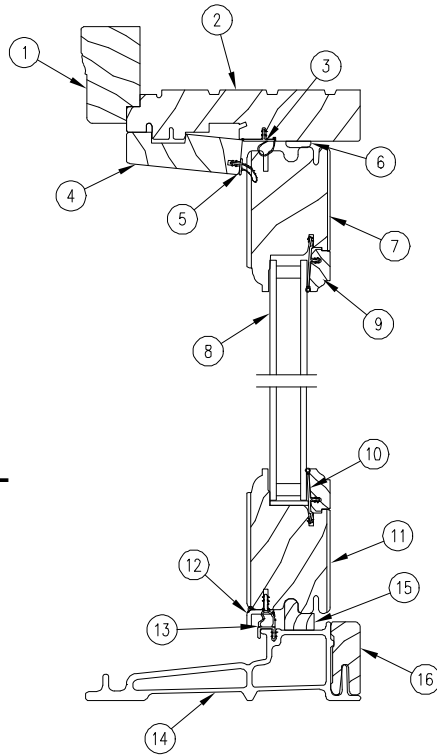
* Standard screen and screen track shown.



JAMB DETAIL - XO

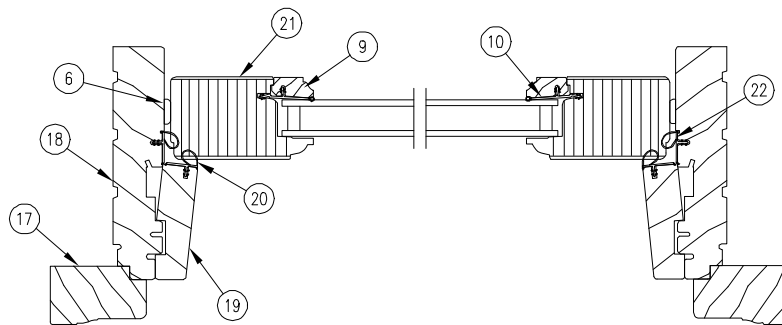
NOTE: Not to scale; specifications subject to change without notice.

ULTIMATE WOOD SLIDING PATIO DOOR STATIONARY



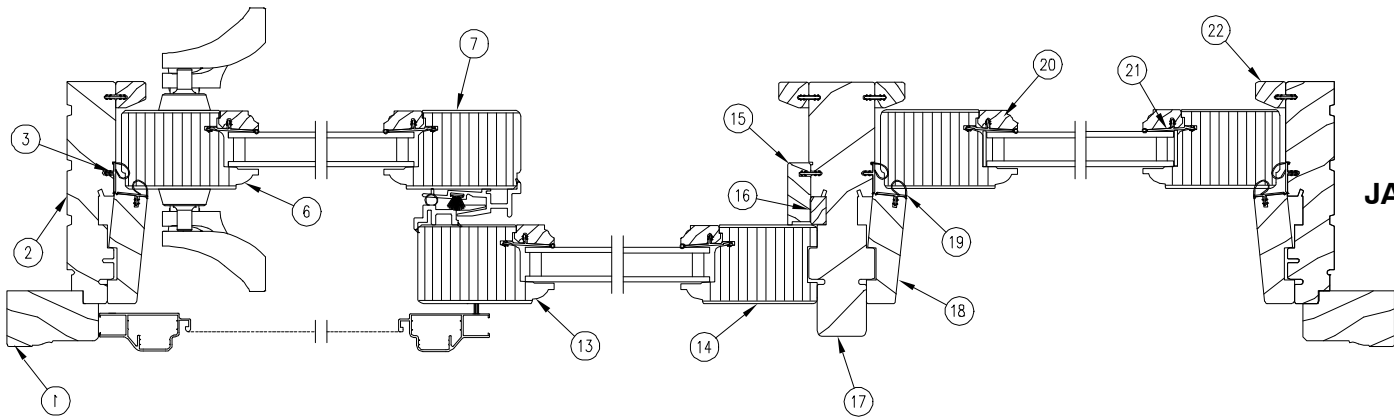
**HEAD JAMB
& SILL DETAIL**

1. Head Jamb Brick Mould Casing
2. Head Jamb
3. Bulb Weather Strip, Head Jamb, V796
4. Head Jamb Parting Stop
5. Parting Stop Weather Strip
6. Spacer Tack
7. Top Rail
8. Insulated Glass
9. Glazing Cap
10. Glazing Bead
11. Bottom Rail
12. Panel Drip
13. Sill Weather Strip
14. Ultrex Sill
15. Stationary Spacer
16. Sill Liner
17. Side Jamb Brick Mould Casing
18. Side Jamb
19. Side Jamb Parting Stop
20. Bulb Weather Strip, Parting Stop, Side Jamb, V796
21. Stile
22. Bulb Weather Strip, Side Jamb, V796

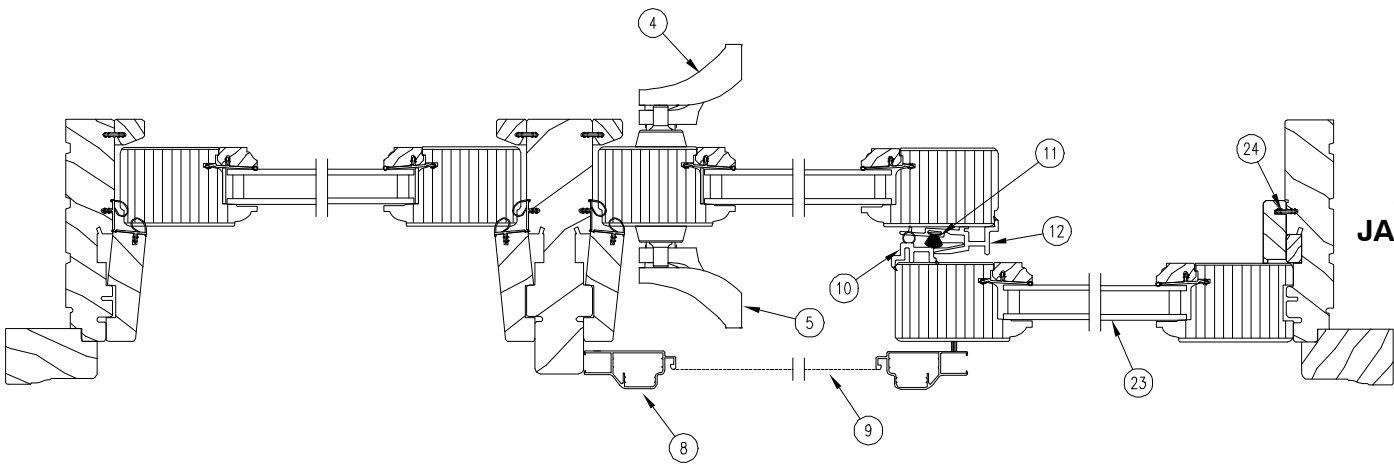


JAMB DETAIL

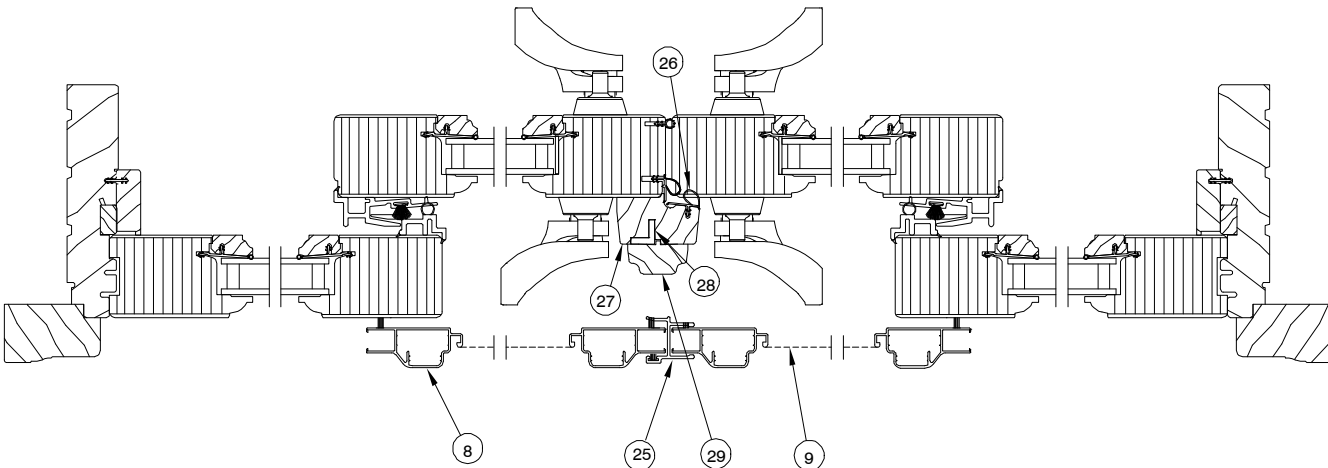
NOTE: Not to scale; specifications subject to change without notice.



**3 PANEL
 JAMB DETAIL
 XOO**



**3 PANEL
 JAMB DETAIL
 OXO**

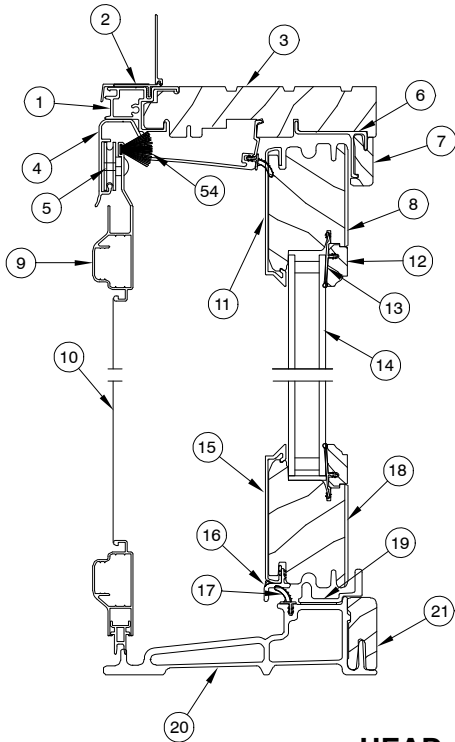


**4 PANEL
 JAMB DETAIL
 OXO**

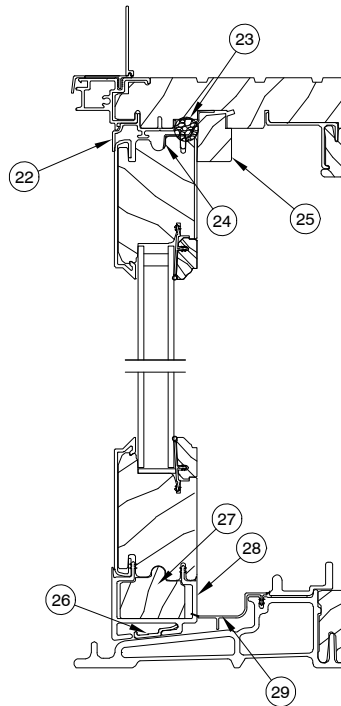
NOTE: Not to scale; specifications subject to change without notice.

- | | | |
|--|--|---|
| 1. Side Brick Mould Casing | 11. Operator Panel Pile Weather Strip | 21. Glazing Bead |
| 2. Side Jamb | 12. Operator Panel Interlock | 22. Jamb Liner |
| 3. Bulb Weather Strip, Side Jamb, V796 | 13. Stationary Meeting Stile | 23. Insulated Glass |
| 4. Interior Handle Assembly | 14. Stationary Jamb Stile | 24. Connecting Barb |
| 5. Exterior Handle Assembly | 15. Stationary Jamb Cover | 25. Screen Astragal |
| 6. Operator Locking Stile | 16. Stationary Jamb Filler | 26. Bulb Weather Strip, Mull Base, V796 |
| 7. Operator Meeting Stile | 17. Center Jamb | 27. Mull Base |
| 8. Screen Frame | 18. Jamb Parting Stop | 28. Mull Base Reinforcement |
| 9. Screen Mesh | 19. Bulb Weather Strip, Parting Stop, V796 | 29. Astragal Cover |
| 10. Stationary Panel Interlock | 20. Glazing Cap | |

OPERATOR PANEL

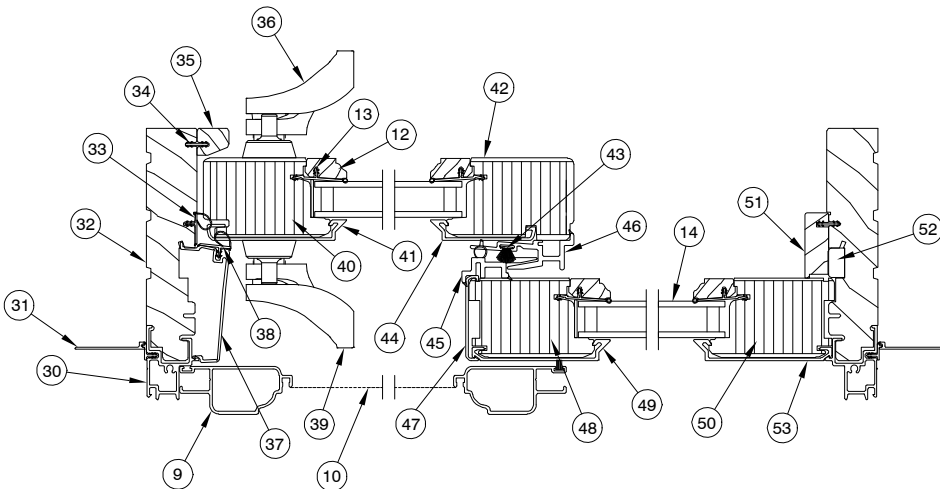


STATIONARY PANEL



HEAD JAMB AND SILL DETAIL

* Standard screen and screen track shown.



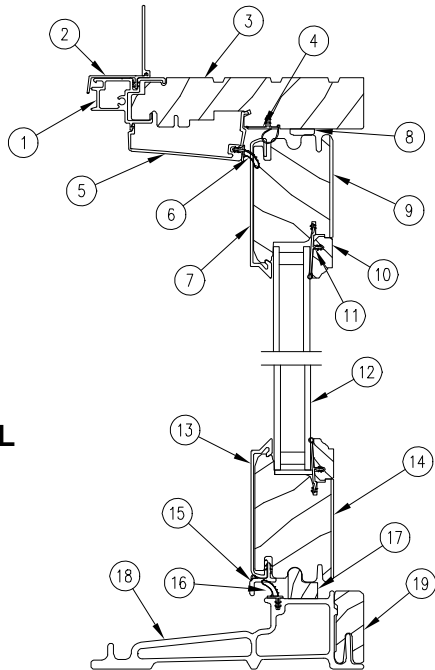
JAMB DETAIL XO

1. Head Jamb Cladding
2. Head Jamb Nailing Fin/Drip Cap
3. Head Jamb
4. Screen Track
5. Screen Roller
6. Panel Guide
7. Header Guide Cover
8. Top Rail
9. Screen Frame
10. Screen Mesh
11. Operator Top Rail Cladding
12. Glazing Cap
13. Glazing Bead
14. Insulated Glass
15. Operator Bottom Rail Cladding
16. Panel Drip
17. Sill Weather Strip, V1194
18. Operator Bottom Rail
19. Sill Roller Track
20. Ultrex Sill
21. Sill Liner
22. Stationary Head Jamb Retainer
23. Backer Rod
24. Stationary Panel Bracket
25. Stationary Panel Head Jamb Cover
26. Sill Stationary Panel Retainer
27. Leveling Block Filler
28. Leveling Block
29. Sill Condensation Cover
30. Side Jamb Cladding
31. Side Jamb Nailing Fin
32. Side Jamb
33. Bulb Weather Strip, Side Jamb, V796
34. Connecting Barb
35. Interior Cover
36. Interior Handle Assembly
37. Jamb Parting Stop
38. Bulb Weather Strip, Parting Stop, V796
39. Exterior Handle Assembly
40. Operator Locking Stile
41. Operator Locking Stile Cladding
42. Operator Meeting Stile
43. Operator Panel Pile Weather Strip
44. Operator Meeting Stile Cladding
45. Stationary Panel Interlock
46. Operator Panel Interlock
47. Edge Cover
48. Stationary Meeting Stile
49. Stationary Meeting Stile Cladding
50. Stationary Jamb Stile
51. Stationary Jamb Cover
52. Stationary Jamb Filler
53. Stationary Jamb Stile Cladding
54. Pile Weather Strip

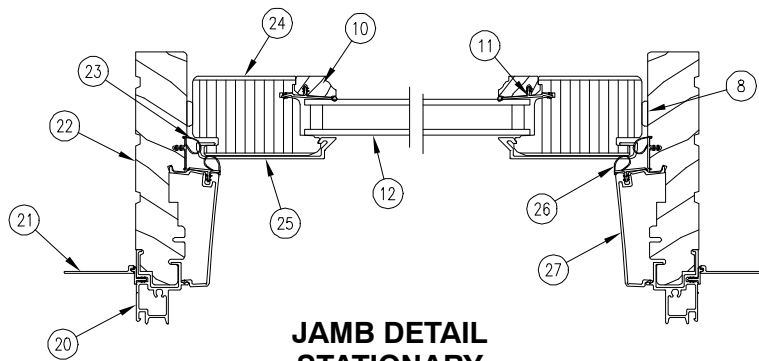
NOTE: Not to scale; specifications subject to change without notice.

**ULTIMATE SLIDING PATIO DOOR
STATIONARY**

**HEAD JAMB
& SILL DETAIL**

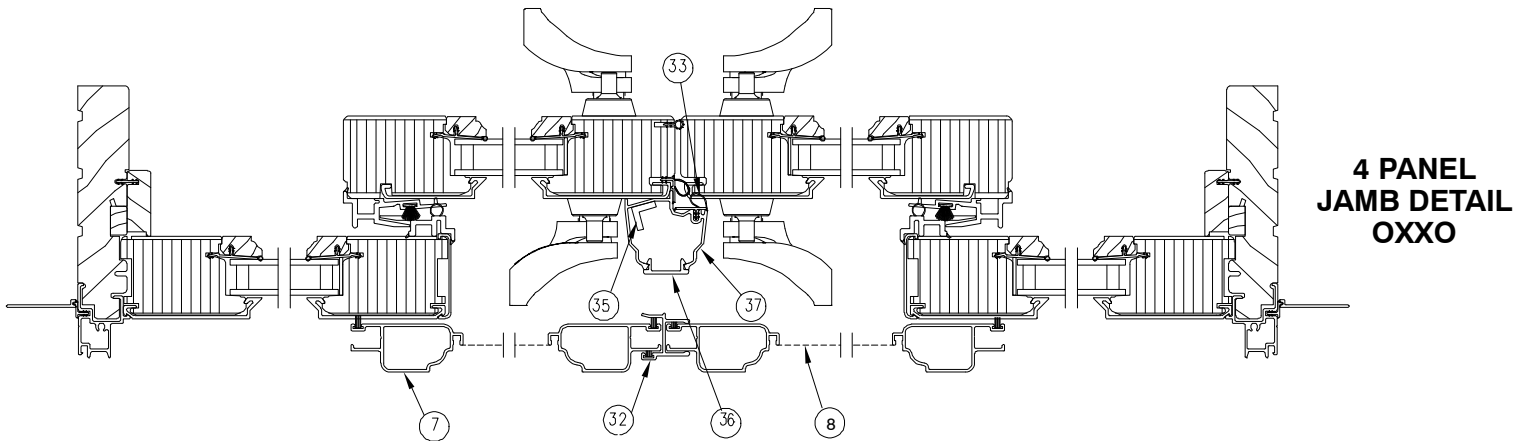
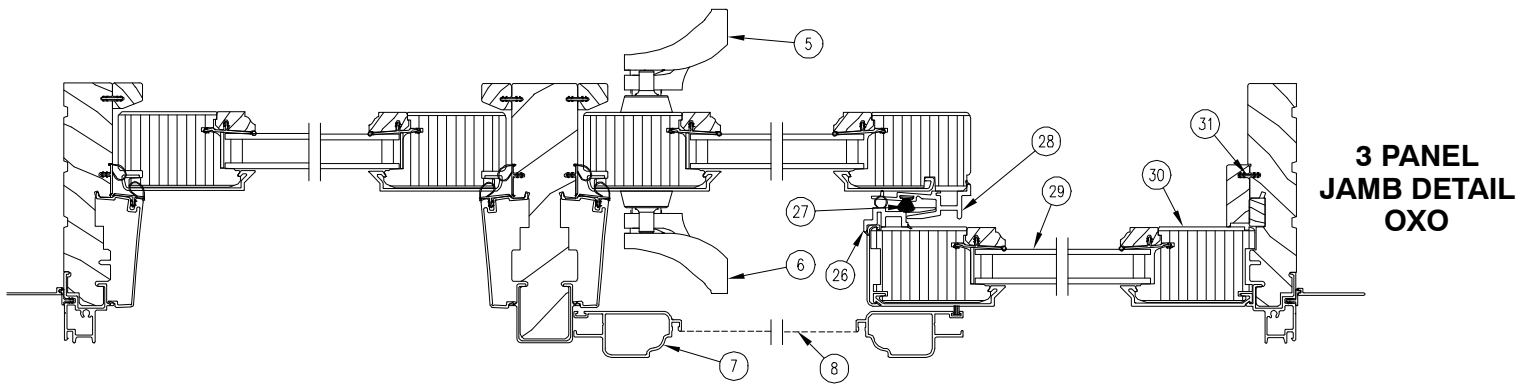
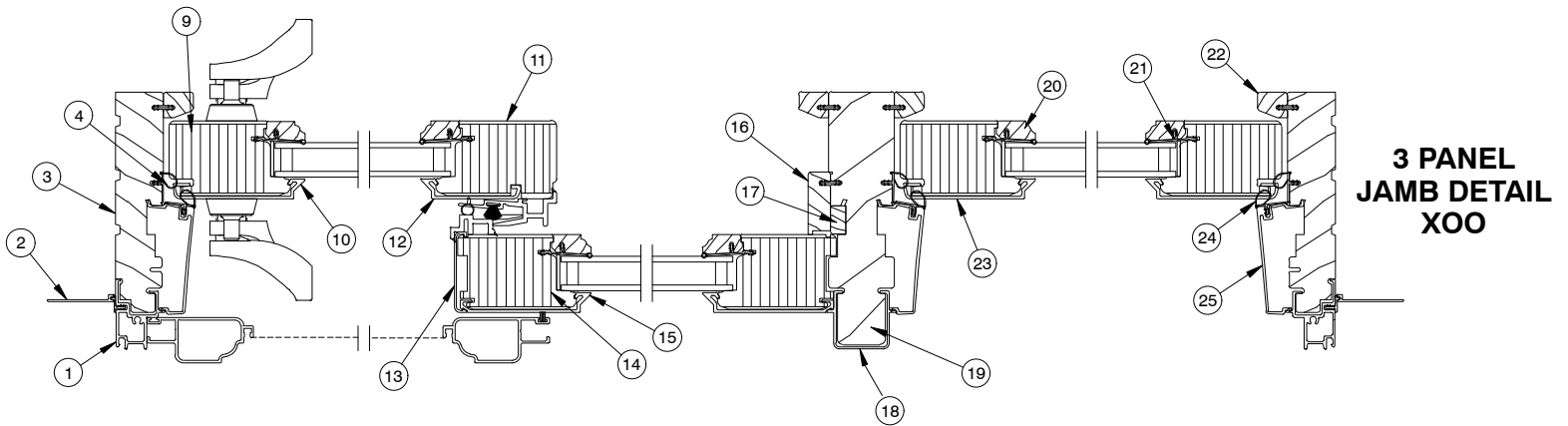


1. Head Jamb Cladding
2. Head Jamb Nailing Fin/Drip Cap
3. Head Jamb
4. Bulb Weather Strip, Head Jamb, V796
5. Head Jamb Parting Stop
6. Parting Stop Weather Strip
7. Top Rail Cladding
8. Spacer Tack
9. Top Rail
10. Glazing Cap
11. Glazing Bead
12. Insulated Glass
13. Bottom Rail Cladding
14. Bottom Rail
15. Panel Drip
16. Sill Weather Strip, V1194
17. Stationary Spacer
18. Ultrex Sill
19. Sill Liner
20. Side Jamb Cladding
21. Side Jamb Nailing Fin
22. Side Jamb
23. Bulb Weather Strip, Side Jamb, V796
24. Stile
25. Stile Cladding
26. Bulb Weather Strip, Parting Stop, V796
27. Parting Stop



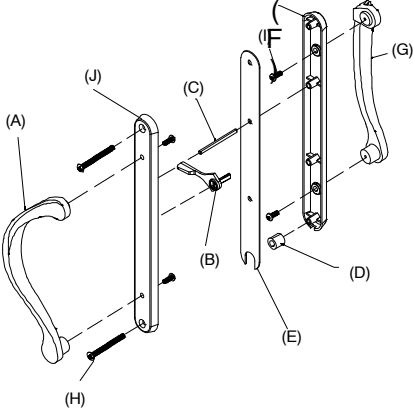
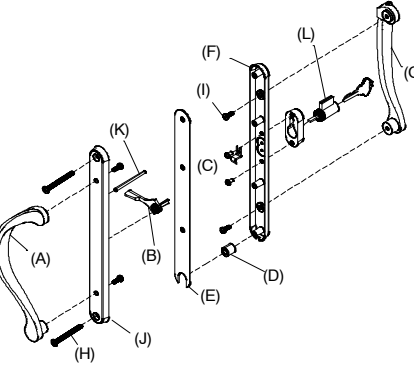
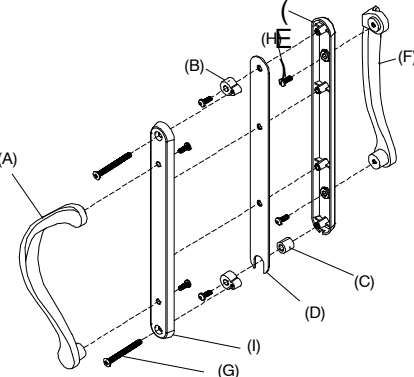
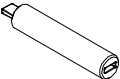


**JAMB DETAIL
STATIONARY**

NOTE: Not to scale; specifications subject to change without notice.



NOTE: Not to scale; specifications subject to change without notice.

- | | | |
|--|--|---|
| 1. Side Jamb Cladding | 14. Stationary Meeting Stile | 27. Operator Pile Weather Strip |
| 2. Side Jamb Nailing Fin | 15. Stationary Meeting Stile Cladding | 28. Operator Panel Interlock |
| 3. Side Jamb | 16. Stationary Jamb Cover | 29. Insulated Glass |
| 4. Bulb Weather Strip, Side Jamb, V796 | 17. Stationary Jamb Filler | 30. Stationary Jamb Stile |
| 5. Interior Handle Assembly | 18. Center Jamb Cladding | 31. Connecting Barb |
| 6. Exterior Handle Assembly | 19. Center Jamb | 32. Screen Astragal |
| 7. Screen Frame | 20. Glazing Cap | 33. Bulb Weather Strip, Mull Base, V796 |
| 8. Screen Mesh | 21. Glazing Bead | 34. Mull Base |
| 9. Operator Locking Stile | 22. Jamb Liner | 35. Mull Base Reinforcement |
| 10. Operator Locking Stile Cladding | 23. Stationary Jamb Stile Cladding | 36. Clad Mull Casing Cover A775 |
| 11. Operator Meeting Stile | 24. Bulb Weather Strip, Parting Stop, V796 | 37. Astragal Cladding A2047 |
| 12. Operator Meeting Stile Cladding | 25. Parting Stop | |
| 13. Edge Cover | 26. Stationary Panel Interlock | |

ILLUSTRATION NOT TO SCALE	DESCRIPTION	OPER./COLOR	PART NO.
	<p>Handle, Non-Keypad <i>Includes:</i> 1 - Interior handle (A) 1 - Thumb Turn Tail Piece (B) 1 - Pin (C) 1 - Bottom lug seal gasket (D) 1 - Exterior escutcheon plate gasket (E) 1 - Exterior escutcheon plate (F) 1 - Exterior handle (G) 2 - M5 x 55mm Phillips ovalhead machine screws or #10-32x2 1/8" Ovalhead machine screws (H)* 4 - M5 x 12mm screws or #10-32x7/16" hex drive panhead screws (I)* 1 - Interior escutcheon plate (J)</p>	<p>Satin Taupe Antique Brass Satin Chrome White Oil Rubbed Bronze ORBZ PVD Brass PVD Satin Nickel PVD Dark Bronze Matte Black</p>	<p>10830366 10830374 10830370 10830364 10830047 10830392 10830376 10830426 10830396 10830438</p>
	<p>Handle, Keypad <i>Includes:</i> 1 - Interior handle (A) 1 - Thumb Turn Tail Piece (B) 1 - Stop clip and screws (C) 1 - Bottom lug seal gasket (D) 1 - Exterior escutcheon plate gasket (E) 1 - Exterior escutcheon plate (F) 1 - Exterior handle (G) 2 - M5 x 55mm Phillips ovalhead machine screws or #10-32x2 1/8" Ovalhead machine screws (H)* 4 - M5 x 12mm screws or #10-32x7/16" hex drive panhead screws (I)* 1 - Interior escutcheon plate (J) 1 - Pin (K) 1 - Keypad cylinder with housing, key and keypad base (L)</p>	<p>Satin Taupe Antique Brass Satin Chrome White Oil Rubbed Bronze ORBZ PVD Brass PVD Satin Nickel PVD Dark Bronze Matte Black</p>	<p>10830386 10830382 10830378 10830388 10830045 10830390 10830384 10830430 10830394 10830440</p>
	<p>Handle, Inactive <i>Includes:</i> 1 - Interior handle (A) 1 - Escutcheon adaptor (B) 1 - Bottom lug seal gasket (C) 1 - Exterior escutcheon plate gasket (D) 1 - Exterior escutcheon plate (E) 1 - Exterior handle (F) 2 - M5 x 55mm Phillips ovalhead machine screws or #10-32x2 1/8" Ovalhead machine screws (H)* 4 - M5 x 12mm screws or #10-32x7/16" hex drive panhead screws (I)* 1 - Interior escutcheon plate (I)</p>	<p>Satin Taupe Antique Brass Satin Chrome White Oil Rubbed Bronze ORBZ PVD Brass PVD Satin Nickel PVD Dark Bronze Matte Black</p>	<p>10830404 10830408 10830402 10830406 10830120 10830436 10830410 10830434 10830398 10830442</p>
	<p>Tail Piece Adaptor – Interior Shades</p>		<p>11800172</p>
	<p>#10-32 x 1 1/2" Machine Screw Extension– Interior Shades</p>		<p>11800170</p>
	<p>Lug seals</p>		<p>00142046</p>

* Screws may differ depending on supplier

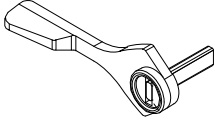




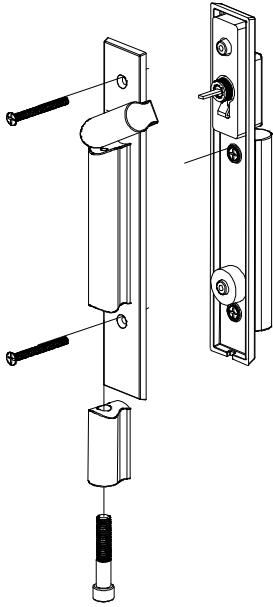
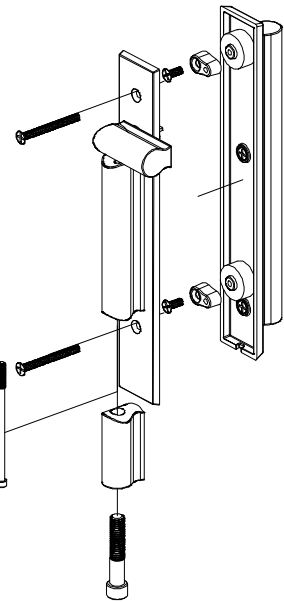
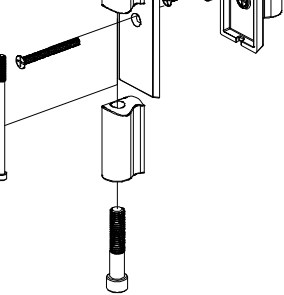
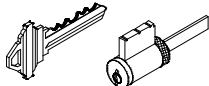

ILLUSTRATION NOT TO SCALE	DESCRIPTION	OPER./COLOR	PART NO.
	Tail Piece, Thumb Turn	Satin Taupe Antique Brass Satin Chrome White Oil Rubbed Bronze ORBZ PVD Brass PVD Satin Nickel PVD Dark Bronze Matte Black Polished Chrome	10148474 10148471 10148470 10148477 10148467 10148473 10148472 10148475 10148469 10148468 10148476
	Escutcheon Adaptor For Inactive Handle <i>Includes:</i> 1 – #10–32x7/16 hex drive panhead stainless steel screw (00143047)	Zinc Diecast	00143048
	#10–32 x 2 1/8" Phillips ovalhead machine screw	Satin Taupe Antique Brass White Satin Chrome Oil Rubbed Bronze Dark Bronze Brass PVD Satin Nickel PVD Matte Black	11800616 00143038 00143036 10840031 10840032 11800654 11800615 11800190 11800181
	M5 x 8 x 55MM PH ovalhead, Full Thread	Satin Taupe Dark Bronze Oil Rubbed Bronze Satin Nickel Matte Black	10148400 10148401 10148402 10148403 10148440
	Rubber Bumper	Beige Black	02101000 02101006

ILLUSTRATION NOT TO SCALE	DESCRIPTION	OPER./COLOR	PART NO.
	Contemporary Handle, Keyed*	Dark Bronze ORBZ PVD Satin Nickel PVD Matte Black	10148206 10148207 10148205 10148208
	Contemporary Handle, Non-Keyed*	Dark Bronze ORBZ PVD Satin Nickel PVD Matte Black	10148215 10148216 10148217 10148218
	Contemporary Inactive Handle*	Dark Bronze ORBZ PVD Satin Nickel PVD Matte Black	10148219 10148220 10148221 10148222
	Key Cylinder (Schlage "C" keyway) For service replacement only. <i>NOTE: For Keyed Alike orders, use program C87P2.</i>	Brass Face Chrome Face	10830216 10830213
	Indexing Tail Piece	Steel	10830155

* Traditional and Contemporary handles are not interchangeable.

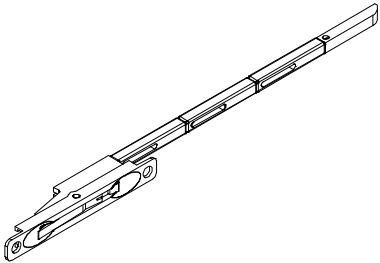
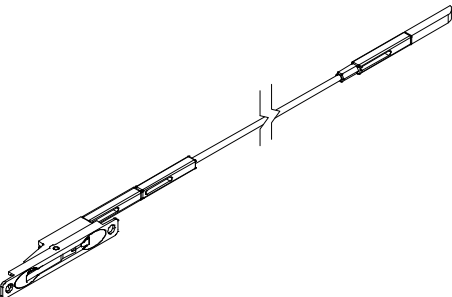
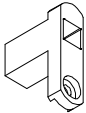
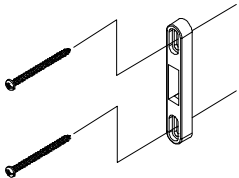
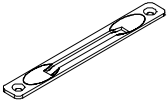
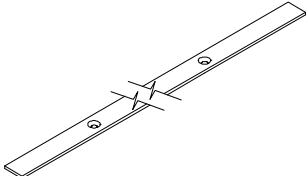
ILLUSTRATION NOT TO SCALE	DESCRIPTION	OPER./COLOR	PART NO.
	<p>Flush Bolt Assembly, 68 For OXXO (length: 16 7/8)</p>		11101755
	<p>Flush Bolt Assembly, 80 For OXXO (length: 32 3/16)</p>		11101756
	<p>End Bolt Guide For OXXO</p>		10815102
	<p>Head Jamb Strike Inactive Panel OXXO Includes: 1 - Strike 2 - t-nut, #8-32 thread (05080250) 2 - #8-32x3/4" machine screw (11800730)</p>	Z Y D	10148195
	<p>Modified Flush Bolt Trim Cover For OXXO</p>	Aluminum	11101759
	<p>Flush Bolt Trim Cover Extension For OXXO</p> <p style="text-align: right;">66R and 68 80</p>	Aluminum Aluminum	11101757 11101758


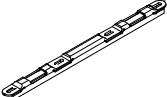
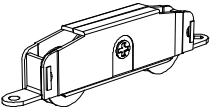
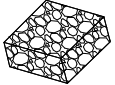
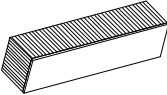
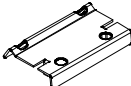
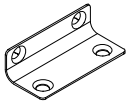
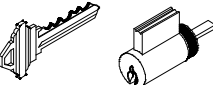

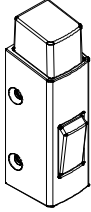
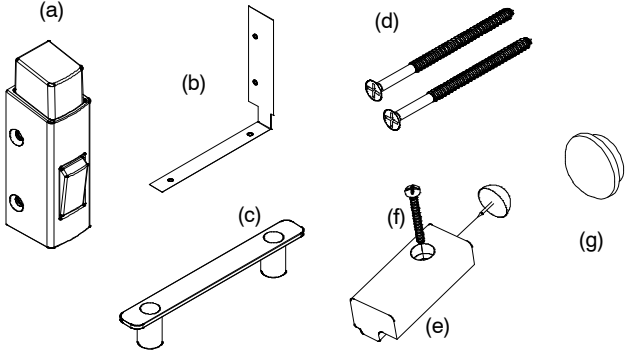
ILLUSTRATION NOT TO SCALE	DESCRIPTION	OPER./COLOR	PART NO.
	Multi Point Lock (Anti-Slam) <i>Includes:</i> 1 - Multi Point lock 2 - #10x1 1/2" Phillips flathead wood screws (11800885)	ZYD	02100937
	Jamb Strike with Screws <i>Includes:</i> 1 - Strike 4 - #8x3" PH panhead screws (11800831)		10150034
	Operator Panel Roller (Tandem-Adjustable) <i>Includes:</i> 1 - Operator panel roller 2 - #8x1" Phillips flathead wood screws (ZYD 11800810) (SS 11800645) NOTE: Must order stainless steel for coastal hardware	ZYD Stainless Steel	10820003 10820004
	Sill Drain Filter		10500240
	Dust Block, Low Profile Sill		10500296
	Stationary Panel Head Jamb Bracket <i>Includes:</i> 1 - Bracket 4 - #8x1" flat head screws (ZYD 11800810)	Galvanized Steel	11860213
	Stationary Panel to Jamb Bracket <i>Includes:</i> 1 - Stationary bracket 2 - #7x 5/8" screws (11800758) 2 - #7x1 1/4" screws (11807113)	Galvanized Steel	11841001
	Key Cylinder for Active Panel For service replacement only. NOTE: For Keyed Alike orders, use program C87P2.	Brass Face Chrome Face	10830216 10830213
	Rubber Bumper	Beige Black	02101000 02101006

ILLUSTRATION NOT TO SCALE	DESCRIPTION	OPER./COLOR	PART NO.
	Foot Bolt	White Beige Bronze	11101777 11101778 11101779

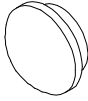


Sliding Door Auxiliary Foot Bolt Kit
Includes:

- 1- Foot bolt (a)
- 1- Installation template with installation instructions (b)
- 1 - Lock plate assembly (c)
- 2 - #8 x 2 3/4" screws (d)
- 1 - Bumper stop (e)
- 1 - #8 x 1 1/2" screw (f)
- 1 - Roller adjustment plug (g)

NOTE: Not available on low-profile sill

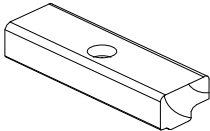
Wood Species	Color/Configuration					
	White/ XO	White /OX	Beige /XO	Beige /OX	Bronze/ XO	Bronze /OX
Pine	11101760	18900611	11101761	18900612	11101762	18900613
Cherry	18900614	18900617	18900615	18900618	18900616	18900619
Vertical Grain Douglas Fir	18900620	18900623	18900621	18900624	18900622	18900625
Mix Grain Douglas Fir	18900638	18900641	18900639	18900642	18900640	18900643
Oak	18900632	18900635	18900633	18900636	18900634	18900637
Mahogany	18900626	18900629	18900627	18900630	18900628	18900631



Roller Adjustment Plug

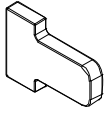
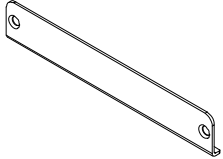
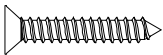
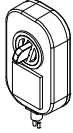
Wood Species	Finish										
	Bare	Prime	White	Designer Black	Clear	Wheat	Honey	Hazelnut	Leather	Espresso	Cabernet
Pine	01060619	11100952	39200619	39200620	31660619	11100910	11100911	11100912	11100913	11100914	11100915
Cherry	01060619C	-	-	-	11100916	11100917	11100918	11100919	11100920	11100921	11100922
Mahogany	01060619M	-	-	-	11100923	11100924	11100925	11100926	11100927	11100928	11100929

NOTE: Douglas fir uses Bare Mahogany plugs.



**Bumper Block,
Head Jamb or Sill**

Wood Species	Finish							Finish				
	Bare	Prime	White	Designer Black	Clear	Wheat	Honey	Hazelnut	Leather	Espresso	Cabernet	
Pine	75151605	75151808	75151807	75151809	75151800	75151801	75151802	75151803	75151804	75151805	75151806	

ILLUSTRATION NOT TO SCALE	DESCRIPTION	OPER./ COLOR	PART NO.
	Tailpiece, Non-keyed, Button Switch	Stainless Steel	10501844
	Cover, Transmitter, L-Shape		10501821
	#8-18 x 1" Type AB, Full Thread <i>Used for Transmitter Cover</i> <i>Need quantity of 2 for each part</i>		11800769
	Micro Switch Assembly	Black	10501847

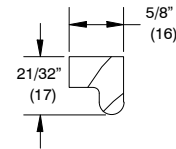
REPLACEMENT WOOD PARTS

When ordering replacement wood parts specify:

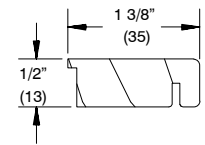
1. profile number;
2. rough opening;
3. handing;
4. length;
5. finish.

	Ultimate	Ultimate Wood
Stationary Panel Bottom Spacer	W8643	W8643
Stationary Jamb Cover	W7535	W7535
Leveling Block Filler	W8270	W8270
Jamb Liner	W7536	W7536
Center Jamb Cover	W7534	W7534
Sill Liner	W2528	W2528
Panel Guide	W8040	W8040
Oak Sill Liner, Low Profile Sill	W10428	W10428
Bumper Stop Block, Low Profile Sill	W10302	W10302
Stationary Panel Head Jamb Cover	W7504	-
Screen Track Filler	-	W5221
Head Jamb and Jamb Parting Stop	-	W6535
Mull Casing Base	-	W9019
Astragal Cover	-	W7554

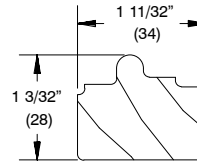
NOTE: Replacement wood parts are supplied with connecting barb (where applicable).



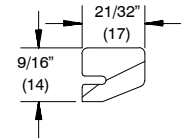
W8643
Stationary Panel
Bottom Spacer



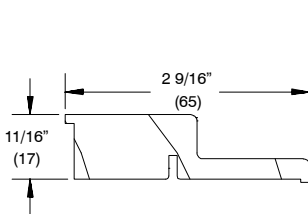
W7535
Stationary Jamb Cover



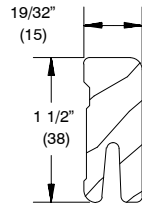
W8270
Leveling Block Filler



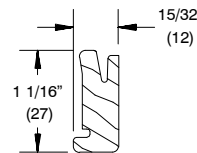
W7536
Jamb Liner



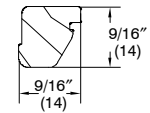
W7534 – Center Jamb Cover



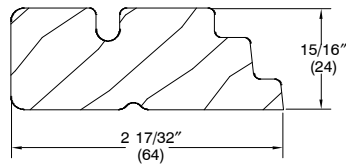
W2528
Sill Liner (Oak)



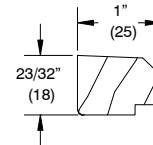
W8040
Panel Guide



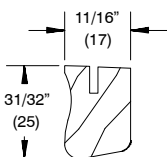
W10428
Oak Sill Liner,
Low Profile Sill



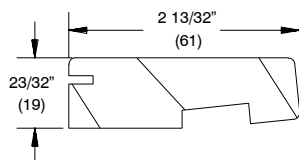
W10302 – Bumper Stop Block,
Low Profile Sill
71271003



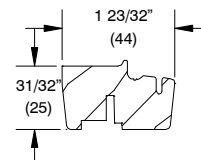
W7504
Stationary Panel
Head Jamb Cover



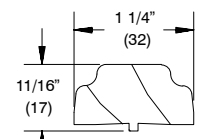
W5221
Screen Track Filler



W6535
Head Jamb and Jamb
Parting Stop



W9019
Mull Casing Base
71520469 – 6/8 Height
71520481 – 8/0 Height



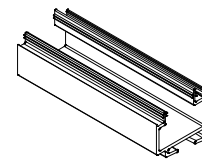
W7554
Astragal Cover

ORDERING REPLACEMENT VINYL AND FIBERGLASS PARTS FOR THE SLIDING PATIO DOOR

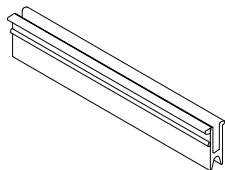
When ordering replacement parts specify:

1. profile number;
2. rough opening;
3. length;
4. handing;
5. finish.

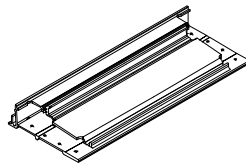
	Ultimate	Ultimate Wood
Leveling Block – Beige or Black	V1755	V1755
Ultimate Screen Guide Bar – Black	V805	V805
Ultrex Sill – Beige or Bronze	F256	F256
Sill, Low Profile	F2017	F2017
Roller Track, Low Profile Sill – Beige or Black	V1846	V1846
Stat Panel Seal, Low Profile Sill – Beige or Black	V1865	V1865
Weather Strip, Interior, Low Profile Sill – Beige or Black	V1793	V1793
Panel Drip, Low Profile Sill – Beige or Black	V1823	V1823
Roller Track – Beige or Black	V1745	–
Condensation Cover – Beige or Black	V1131	–



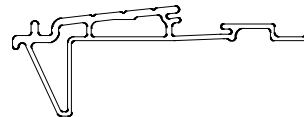
V1755
Leveling Block



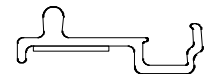
V805
Ultimate Screen Guide Bar



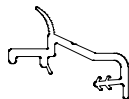
F256 – Ultrex Sill



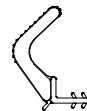
F2017
Low Profile Sill



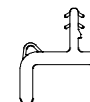
V1846
Roller Track,
Low Profile Sill



V1865
Stationary Panel Seal,
Low Profile Sill



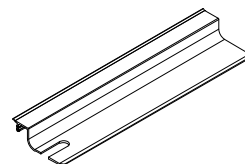
V1793
Weather Strip,
Low Profile Sill, Interior



V1823
Panel Drip,
Low Profile Sill



V1745
Roller Track



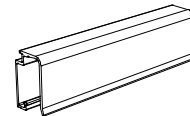
V1131
Condensation Cover

REPLACEMENT ALUMINUM PARTS FOR THE SLIDING PATIO DOOR

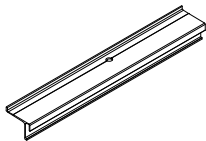
When ordering replacement parts specify:

1. profile number;
2. rough opening;
3. length;
4. handing;
5. finish.

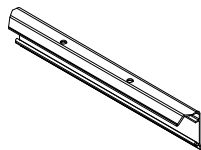
	Ultimate	Ultimate Wood
Ultimate Screen Track	A777	A777
Header Panel Guide Fastener	A1014	A1014
Standard Screen Track	A1070	A1070
Astragal Base	A771	-
Base Reinforcement	A1409	-
Astragal for OXXO door	A2047	-
Mull Casing Cover to use with A2047	A775	-
Head Jamb, Jamb Parting Stop	A836	-
Stationary Meeting Stile Edge Cover	A778	-



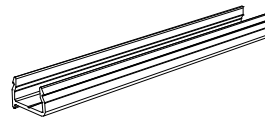
A777
Ultimate Screen Track



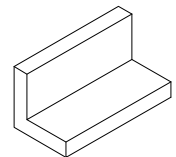
A1014
Header Panel Guide
Fastener



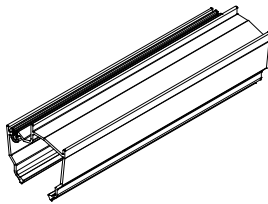
A1070
Standard Screen Track



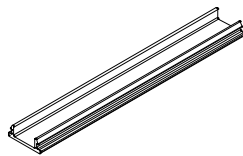
A771
Astragal Base



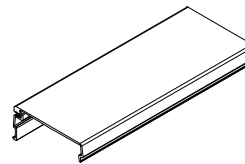
A1409
Base Reinforcement
18620090 – 6/8 Height
18620073 – 8/0 Height



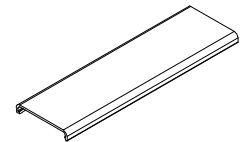
A2047
Astragal



A775
Mull Casing Cover



A836
Head Jamb/Jamb
Parting Stop

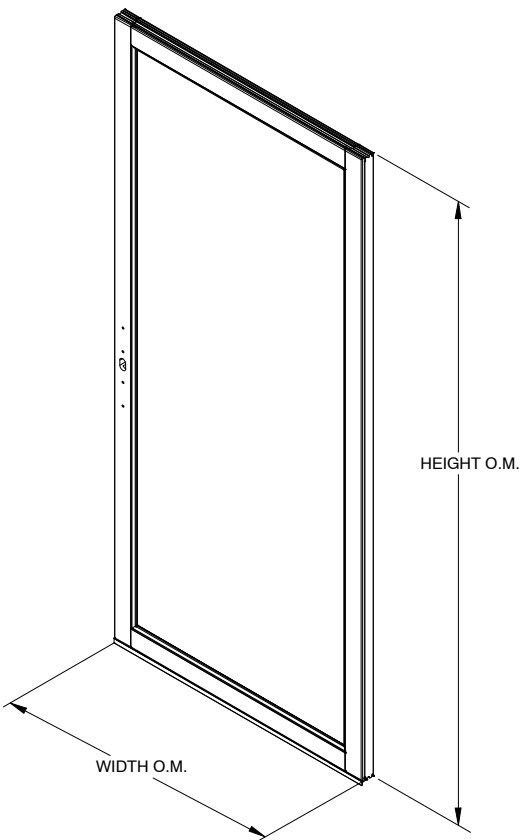


A778
Stationary Meeting Stile
Edge Cover

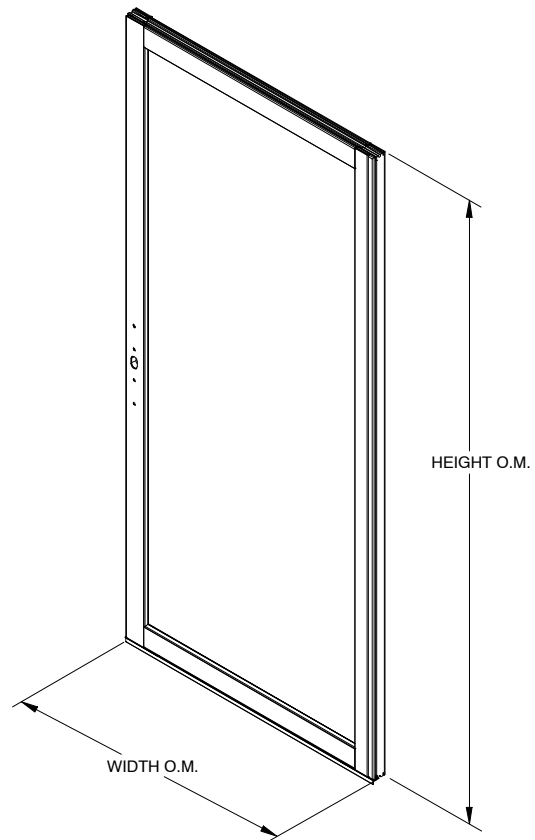
ORDERING REPLACEMENT PANELS FOR THE SLIDING PATIO DOOR

To order replacement panels specify:

1. OM of panel;
2. active, inactive, or stationary;
3. handing;
4. glazing;
5. finish
6. interior wood glazing bead option (Ovolo or Square).



**Ultimate Wood Active Panel
Exterior View**



**Ultimate Active Panel
Exterior View**

NOTE: Active panels include meeting stile weather strip, panel drip and interlock.

Stationary panels include a stationary top filler, leveling block and leveling block filler.

SLIDING PATIO DOOR WEATHER STRIP

When ordering replacement weather strip specify:

1. quantity;
2. length;
3. part number;
4. description.

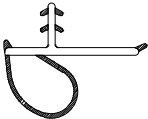
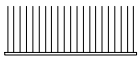
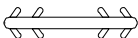



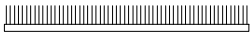
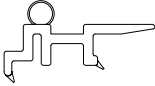
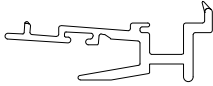

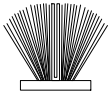
ILLUSTRATION <i>NOT TO SCALE</i>	DESCRIPTION	LENGTH	OPER./COLOR	PART NUMBER
	Bulb Weather Strip, Head Jamb, Side Jamb, Parting Stop, Astragal and Transom V796	189 23/32" 189 23/32"	Beige Black	15173298 15173398
	Stationary Panel Cover Pile Dust Block Adhesive backed 2 1/4" x 1 3/8" x 1/2"		Gray	15600004
	Connecting Barb V803 NOTE: Color may vary depending on current stock.	Specify Length		15812999
	Bulb Weather Strip V1297 For OXXO unit	Specify Length	Beige Black	15351499 15351500
	Weather Strip, Foam Leaf, Sill, Meeting Stile and Head Jamb Parting Stop V1194	Specify Length (LF)	Beige Black	17003595 17003596

ILLUSTRATION <i>NOT TO SCALE</i>	DESCRIPTION	LENGTH	OPER./ COLOR	PART NUMBER
	Dust Block, Part Stop 1 3/8" x 3/8" x 1/2"		Gray	15600010
	Dust Block, Astragal or Panel 1 3/8" x 1/4" x 3/8"			10500049
	Interlock, Stationary Panel V715			
	66R ht. 68 ht. 80 ht. Lineal	76 5/8" 79 1/8" 92 5/8" 110 5/8"	Beige	15211476 15211468 15211480 15211496
	66R ht. 68 ht. 80 ht. Lineal	76 5/8" 79 1/8" 92 5/8" 110 5/8"	Black	15211766 15211469 15211481 15211497
	Interlock, Operating Panel V714			
	66R ht. 68 ht. 80 ht. Lineal	75 19/32" 78 3/32" 91 19/32" 109 19/32"	Beige	15211575 15211568 15211580 15211596
	66R ht. 68 ht. 80 ht. Lineal	75 19/32" 78 3/32" 91 19/32" 109 19/32"	Black	15211666 15211569 15211581 15211597
	Inactive Panel Stile Center V780			
		150" 150"	Beige Black	15174099 15174098
	Pile Weather strip, Check Rail Operating Interlock	LF	Beige	11107533

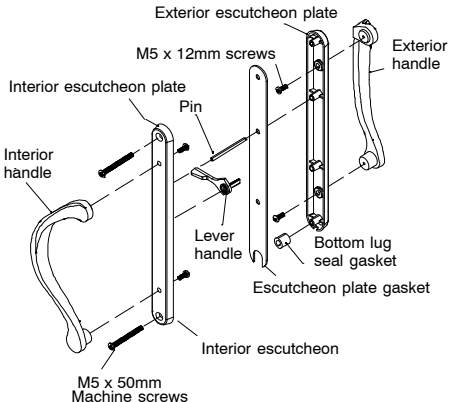
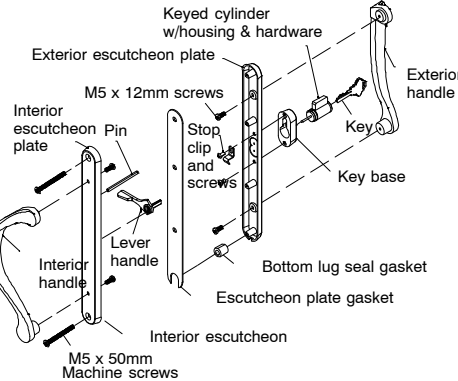
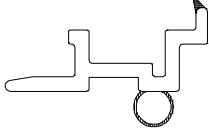
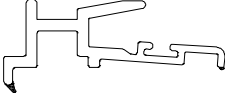
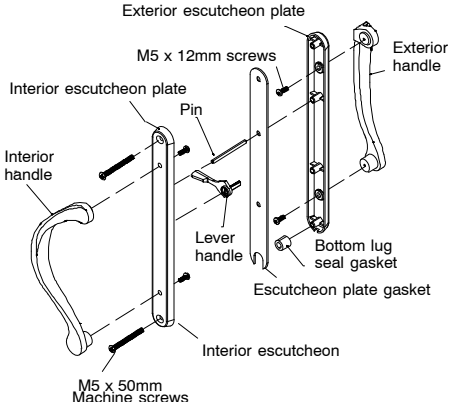
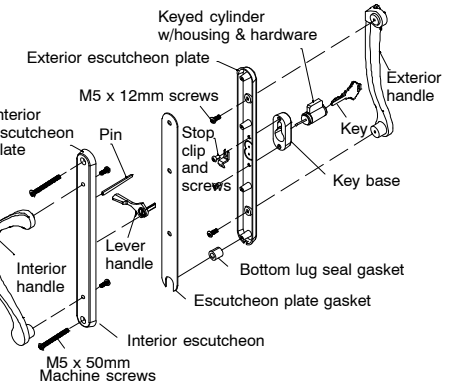


<p>ILLUSTRATION <i>NOT TO SCALE</i></p>	<p>DESCRIPTION</p>	<p>OPER./COLOR</p>	<p>PART NO.</p>
 <p>Exterior escutcheon plate M5 x 12mm screws Exterior handle Interior escutcheon plate Pin Interior handle Lever handle Bottom lug seal gasket Escutcheon plate gasket Interior escutcheon M5 x 50mm Machine screws</p>	<p>Handle, Non-Keypad</p>	<p>Polished Chrome</p>	<p>10830368</p>
 <p>Keyed cylinder w/housing & hardware Exterior escutcheon plate M5 x 12mm screws Exterior handle Interior escutcheon plate Pin Interior handle Lever handle Stop clip and screws Key Key base Bottom lug seal gasket Escutcheon plate gasket Interior escutcheon M5 x 50mm Machine screws</p>	<p>Handle, Keypad</p>	<p>Polished Chrome</p>	<p>10148230</p>

ILLUSTRATION NOT TO SCALE	DESCRIPTION	LENGTH	COLOR	PART NO.
	Interlock, Stationary Panel V715	160"	Beige	15211099
	Interlock, Operating Panel V714	109 1/2"	Beige	15211596

DISCONTINUED WEATHER STRIP – SLIDING PATIO DOOR

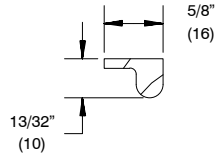
ILLUSTRATION <i>NOT TO SCALE</i>	DESCRIPTION	LENGTH	OPER./ COLOR	PART NUMBER
	Head Jamb/Parting Stop/Astragal Weather Strip V795	79 5/16"	Black	15646069

ILLUSTRATION NOT TO SCALE	DESCRIPTION	OPER./COLOR	PART NO.
	<p>Handle, Non-Keypad</p>	<p>Bright Brass</p>	<p>No longer Available</p>
	<p>Handle, Keypad</p>	<p>Bright Brass</p>	<p>No longer Available</p>
	<p>#10-32x2" Phillips ovalhead machine screw</p>	<p>Polished Chrome</p>	<p>No longer Available</p>
	<p>Stop clip with screws NA as individual part – 02-2011</p>		<p>No longer Available</p>

DISCONTINUED WOOD PARTS – NO LONGER AVAILABLE (NA)

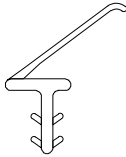

	Ultimate	Ultimate Wood
Stationary Panel Top Spacer*	W8452*	W8452*

* Replaced with stationary bracket



W8452 – Stationary Panel
 Top Spacer*
 Replace with PN 11860213

DISCONTINUED WEATHER STRIP – SLIDING PATIO DOOR

ILLUSTRATION <i>NOT TO SCALE</i>	DESCRIPTION	LENGTH	OPER./ COLOR	PART NUMBER
	Head Jamb, Parting Stop, Astragal Weather Strip V795	79 5/16"	Beige	No longer available
	Weather Strip, Foam Leaf, Sill or Meeting Stile V1138	Specify length	Beige Black	No longer available Replace with V1194

TRIMLINE PATIO DOOR DISC PRE 2003

When ordering replacement parts specify:

1. type of unit;
2. part number;
3. description.

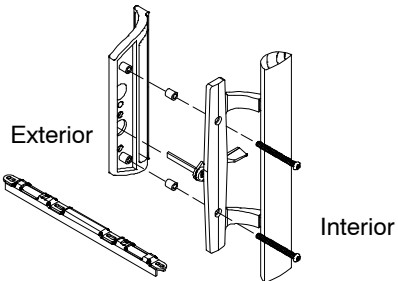
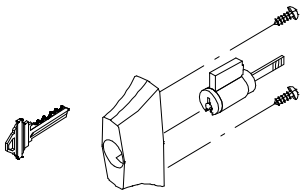
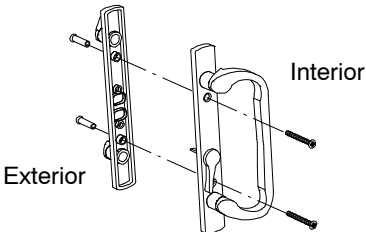
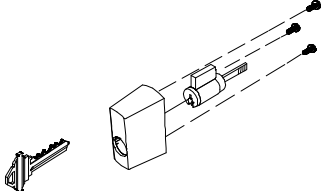
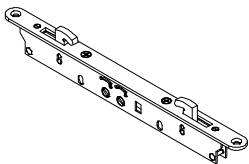
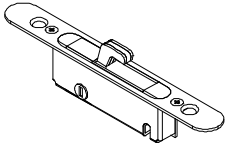
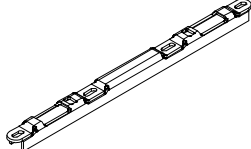
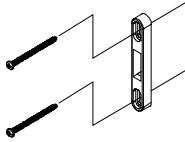
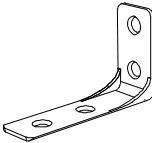

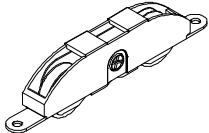


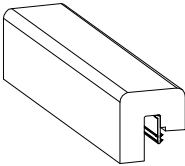
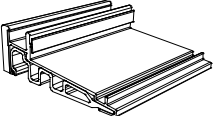
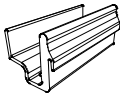
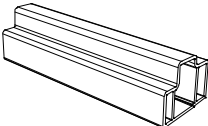
ILLUSTRATION NOT TO SCALE	DESCRIPTION	OPER./ COLOR	PART NO.
	<p>Handle Package</p> <p>1 – Interior handle with wooden insert and turn lever 1 – Exterior handle 2 – Handle gaskets 2 – #10-24x2" Phillips panhead machine screws 1 – Multi-point keeper 4 – 8x2 1/2" panhead wood screws</p>	Beige	10150032
	<p>Key Lock with Housing Schlage "C" Keyway</p> <p>Includes: 1 – Keyed cylinder with housing 2 – Keys 2 – #8x 3/8" Phillips trusshead machine screws</p>	Beige	10150010
	<p>Handle Assembly</p> <p>Includes: 1 – Interior handle with escutcheon plate and turn lever 1 – Exterior handle with escutcheon plate 2 – #10-20x 1 3/4" Phillips ovalhead machine screws with cap nuts</p>	Brass	05590100
	<p>Key Lock with Housing Schlage "C" keyway for brass handle</p> <p>Includes: 1 – Keyed cylinder with housing 2 – Keys 3 – #8x3/8" Phillips trusshead machine screws</p>	Brass	02100563
	<p>Mortise Lock</p> <p>Includes: 1 – Mortise lock 2 – #8x1 1/2" Phillips flathead wood screws.</p>	ZYD	10150030
	<p>Mortise Lock Used between 1991 – 8/98</p> <p>Includes: 1 – Mortise lock 2 – #8x1 1/2" Phillips flathead wood screws.</p>	ZYD	02100960
	<p>Multi-Point Keeper with Screws</p> <p>Includes: 1 – Keeper 4 – #8x2 1/2" Phillips panhead wood screws.</p>	ZYD	10150038

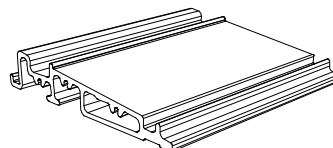
ILLUSTRATION NOT TO SCALE	DESCRIPTION	OPER./ COLOR	PART NO.
	Jamb Strike with Screws Used between 1991 – 8/98 <i>Includes:</i> 1 – Strike 2 – #8x2 1/2" Phillips flathead wood screws.	ZYD	02100961
	Straight Angle Bracket (Top) MISC 014 <i>Includes:</i> 1 – Straight angle bracket 2 – #7x1 1/4" Phillips flathead wood screws (panel) 2 – #8x1" Phillips flathead wood screws (head jamb)	Beige	11100101
	Sill Stationary Panel Bracket MISC 0686 <i>Includes:</i> 1 – Sill stationary panel bracket 1 – #7x1 1/4" Phillips flathead wood screw (panel) 1 – #8-32x3/4" Phillips flathead machine screw (sill)	Beige	11100357
	Operator Panel Roller (Tandem-Adjustable) <i>Includes:</i> 1 – Operator panel roller 2 – #8x1" Phillips flathead wood screws		10820000
	Roller Adjustment Plug	Beige	11170001
	Rubber Bumper	Beige	02101000
	Door Stop, Sill V807 Used between 1991 – 1995 with V790/F250 Sill Cover and Ultrex Sill Core assembly. Current 5/98 to Present	Beige	18051303
	Sill Cover and Ultrex Sill Core Assembly V790/F250 Used between 1991 – 1995	Beige	Check availability
	Roller Track V769 Used between 1995 – 5/98.	Beige	Check availability
	Leveling Block V858 Used between 1991 – 1995. Has been replaced with V766 – Leveling Block.	Beige	Check availability

DISCONTINUED VINYL AND FIBERGLASS PARTS – LIMITED AVAILABILITY (LA)

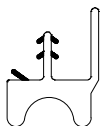
When ordering replacement parts specify:

1. profile number;
2. rough opening
3. length;
4. handing;
5. finish.

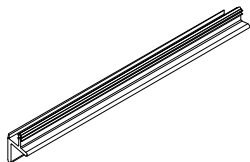
	Ultimate	Ultimate Wood
Ultrex Sill – Beige	F254	F254
Panel Drip – Beige	V800	V800
Panel Drip – Beige or Black	V1012	V1012
Leveling Block – Beige	V766	V766
Screen Track – Brown	---	V365



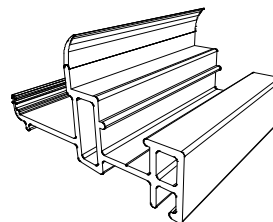
F254
Ultrex Sill



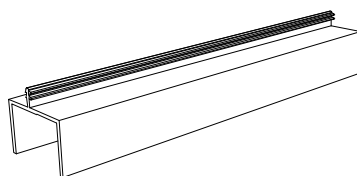
V800
Panel Drip



V1012
Panel Drip



V766
Leveling Block



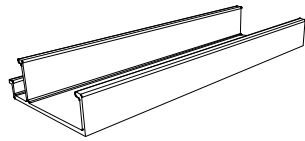
V365
Screen Track – Brown

DISCONTINUED ALUMINUM PARTS – LIMITED AVAILABILITY (LA)

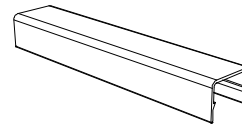
When ordering replacement parts specify:

1. profile number;
2. rough opening
3. length;
4. handing;
5. finish.

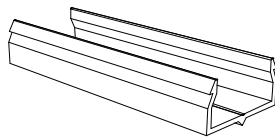
	Ultimate	Ultimate Wood
Head Jamb and Jamb Filler	A802	---
Mullion Cap	A808	---
Mullion Cap Base	A809	---
Center Jamb (with filler block)	A810	---



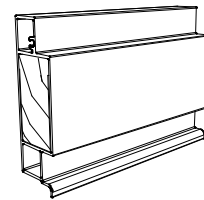
A802
Head Jamb and Jamb Filler



A808
Mullion Cap



A809
Mullion Cap Base



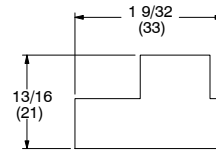
A810
Center Jamb
(with filler block)

DISCONTINUED WOOD PARTS (LA)

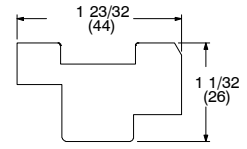
When ordering replacement wood parts specify:

1. profile number;
2. rough opening;
3. handing;
4. length;
5. finish.

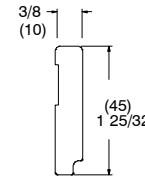
	Ultimate	Ultimate Wood
Stationary Panel Filler	W7286	W7286
Stationary Panel Top Filler	W7270	W7270
Sill Liner	W7532	W7532
Leveling Block Filler	W7508	W7508
Head Jamb and Jamb Parting Stop	W7280	W7280
Head Jamb Liner and Stationary Jamb Liner	W7274	W7274
Panel Guide	W7278	W7278
Operating Panel Track	W7279	W7279
Jamb Liner	W7276	W7276
Stationary Panel Liner	W7296	W7296
Stationary Quarter Round Stop	W7003	W7003
Sill Liner	W7507	W7507
Interior Mull Casing	---	W1098
Exterior Mull Casing	---	W1097
Center Jamb	---	W7292
Panel Opening Filler	---	W7282



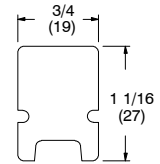
W7286
Stationary Panel Filler
(OOX or XO)



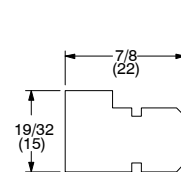
W7270
Stationary
Panel Top Filler



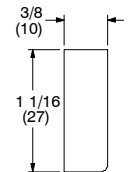
W7532
Sill Liner (Oak)



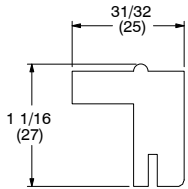
W7508
Leveling Block Filler



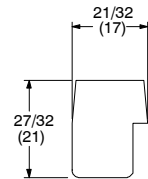
W7280
Head Jamb and
Jamb Parting Stop



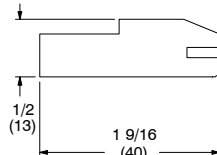
W7274
Head Jamb Liner
and Stationary Jamb Liner



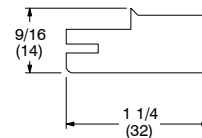
W7278
Panel Guide



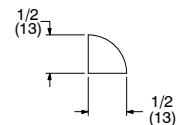
W7279
Operating Panel Track



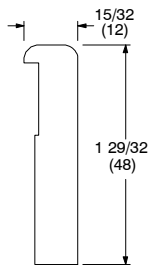
W7276
Jamb Liner



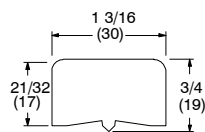
W7296
Stationary Panel Liner
(OXO)



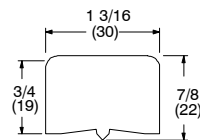
W7003
Stationary (O)
Quarter Round Stop



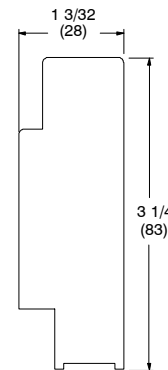
W7507
Sill Liner (Oak)



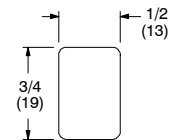
W1098
Interior Mull Casing
(OOX or XO)



W1097
Exterior Mull Casing
(OOX or XO)


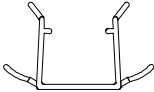
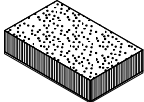

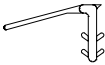
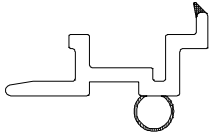
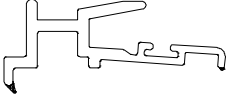
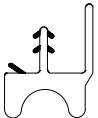


W7292
Center Jamb
(OXO)



W7282
Panel Opening Filler

DISCONTINUED WEATHER STRIP – LIMITED AVAILABILITY (LA)

ILLUSTRATION <i>NOT TO SCALE</i>	DESCRIPTION	LENGTH	COLOR	PART NUMBER
	Leaf Weather Strip, Panel Guide and Jamb Liner V245	150"	Beige	15189999
	Parting Stop Weather Strip, Stationary Jamb, Head Jamb V735	150"	Beige	15619700
	Dust Block MISC 443		Gray	15600004
	Pile Weather Strip, Operator Panel Interlock 17/64" x 21/64"	Specify length	Beige	11107533
	Sill Weather Strip V791	99 5/16"	Beige	15641160
	Interlock, Stationary Panel V715	160"	Beige	15211099
	Interlock, Operating Panel V714	109 1/2"	Beige	15211596
	Panel Drip V800 Used between 1991 – 1995. Current 5/98 to present.	150"	Black Beige	15978490 15978499

ORDERING REPLACEMENT PANELS FOR THE TRIMLINE PATIO DOOR DISC PRE 2003

To order replacement panels specify:

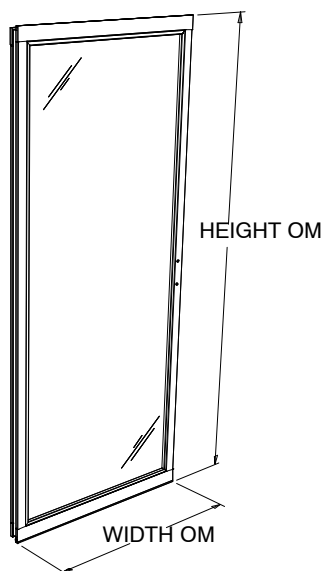
- | | |
|----------------------------|---------------------------------|
| 1. OM of panel; | 4. glazing; |
| 2. operator or stationary; | 5. finish. |
| 3. handing; | 6. Single-Point or Multi-Point. |

ULTIMATE AND ULTIMATE WOOD TRIMLINE DOOR (PRE 1998)

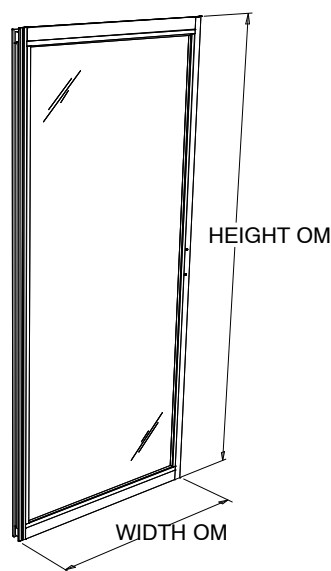
CN	Panel OSM		Panel DLO	
	Width	Height	Width	Height
2665	28 15/16"	75 15/16"	24 7/16"	70 5/16"
3065	34 15/16"	75 15/16"	30 7/16"	70 5/16"
4065	46 15/16"	75 15/16"	42 7/16"	70 5/16"
2668	30 7/16"	79 3/16"	25 15/16"	73 9/16"
3068	36 7/16"	79 3/16"	31 15/16"	73 9/16"
4068	48 7/16"	79 3/16"	43 15/16"	73 9/16"
8/0 Height		95 3/16"	same as 6/8	89 9/16"

Units will have:

- 2 13/16" top and bottom rail and 2 1/4" stiles.
- Single Point Lock used until November 2002.
- DLO width same on 6/8 and 8/0.

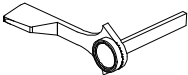

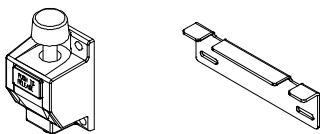
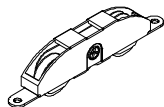
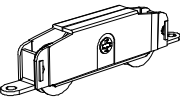
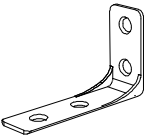
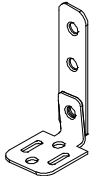
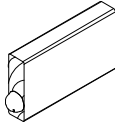
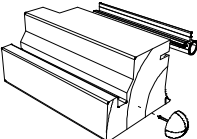
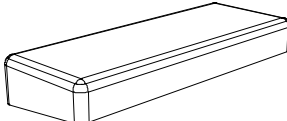
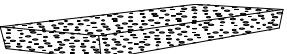
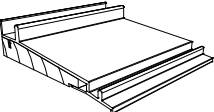


**Ultimate Wood
Operator Panel
Exterior View**



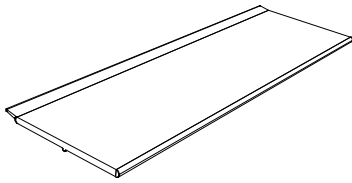
**Ultimate
Operator Panel
Exterior View**

NOTE: Operator panel include sash rollers, panel drip, interlock and interlock end cap with gasket, and mortise lock (installed).
Stationary panel includes stationary panel top filler, leveling block filler, interlock and straight angle bracket (with screws taped to panel).

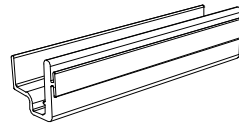
ILLUSTRATION NOT TO SCALE	DESCRIPTION	OPER./COLOR	PART NO.
	Turn Lever		No longer available
	Handle Gasket		No longer available
	Auxiliary Foot Bolt, Package (Replace with current foot bolt kit – Sliding Patio Door)		No longer available
	Operator Panel Roller, Small (Tandem-Adjustable) <i>Includes:</i> 1 – Operator panel roller 2 – #8x1" Phillips flathead wood screws	Stainless Steel	No longer available
	Operator Panel Roller, Large (Tandem-Adjustable) <i>Includes:</i> 1 – Operator panel roller 2 – #8x1" Phillips flathead wood screws	Stainless Steel	No longer available
	Straight Angle Bracket (Top) MISC 014 Has been replaced with Straight Angle Bracket 11100101 (beige)	Z Y D	No longer available Replace with 11100101 (Beige)
	Adjustable Angle Bracket (Bottom)		No longer available
	Door Stop, Head Jamb		No longer available
	Door Stop Assembly, Sill MISC 1722 Used 1995 through 5/98		No longer available
	Sill Block MISC 2238 19/64" x 5/16" x 2"		No longer available
	Jamb Gasket, Sill Weather Strip/Jamb 1/8" x 5/8" x 2"	Black	No longer available
	Lexan Sill with Wood Core Used between 1988 – 1991	Brown	No longer available

DISCONTINUED REPLACEMENT VINYL (NO LONGER AVAILABLE)

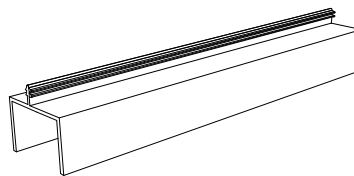
	Ultimate	Ultimate Wood
Roller Track – Beige	V786	V786
Roller Track Cover – Beige	V830	V830
Screen Track – White	---	V007



V830
Roller Track Cover



V786
Roller Track



V007
Screen Track – White

DISCONTINUED WEATHER STRIP – NO AVAILABILITY (NA)

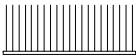
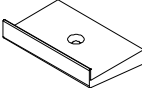
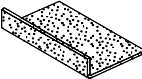
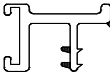
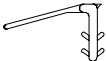

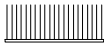

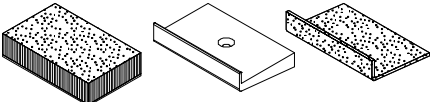

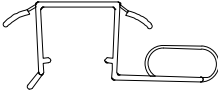
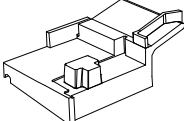
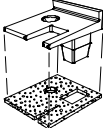
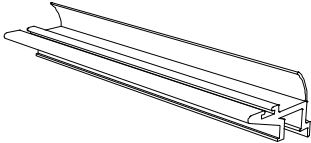

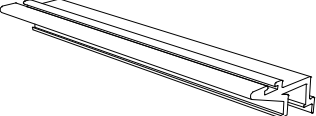
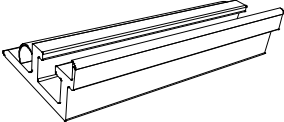
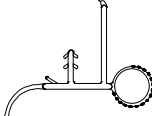
ILLUSTRATION <i>NOT TO SCALE</i>	DESCRIPTION	LENGTH	COLOR	PART NUMBER
	Pile Weather Strip, Head Jamb Adhesive backed 11/16" x 31/64" x 2 1/4"		Gray	No longer available
	Dust Block Support V956			No longer available
	Dust Block Support Gasket			No longer available
	Bottom Seal Weather Strip V746 Used between 1988 – 1991			No longer available
	Sill Weather Strip V791 Used between 1991 – 1995 and 5/98 to 2003	99 5/16"	Beige	No longer available
	Interlock and Bottom Seal Pile Weather Strip Used between 1988 – 1991			No longer available
	Sill Dust Block Pile Weather Strip Used between 1988 – 1991			No longer available
	Sill Foam Block Weather Strip Used between 1988 – 1991			No longer available
	Dust Block Assembly MISC 2252 Used between 1991 – 1995.			No longer available
	Foam Interlock Weather Strip V750 Used between 1991 – 1995 Color: Beige			No longer available
	Parting Stop Weather Strip, Operating Jamb V777 Used before 1/98		Beige	No longer available
	Hydroseal MISC 2252 Used between 1995 – 1/98		Black	No longer available
	End Cap (with gasket) MISC 2245 Used between 1995 – 1/98		Beige	No longer available

ILLUSTRATION NOT TO SCALE	DESCRIPTION	LENGTH	COLOR	PART NUMBER
	Interlock, Stationary Panel V747 Ultimate Wood only Used between 1988 –1995 and 1996 – 1/98		Beige	No longer available
	Interlock, Stationary Panel V472 Ultimate only Used between 1990 –1995 and 1996 – 1/98		Beige	No longer available
	Interlock, Operating Panel V471 Used between 1988 –1995 and 1996 – 1/98		Beige	No longer available
	Interlock, Stationary & Operating Panel V755 Used between '95 – '96		Beige	No longer available
	Panel Drip V760 Used between 1995 – 5/98.		Beige	No longer available