

WOOD AND CLAD OUTSWING BI-FOLD DOOR

Table of Contents

NOTICE: Marvin Windows and Doors discontinued the sale of 1 3/4" panel wood and clad Bi-fold doors effective April 24, 2017. The 2 1/4" panel Clad Ultimate Bi-fold Door (CMOBFD) is the current platform for this door. Marvin will continue to provide full support with a complete line of hardware and replacement parts as specified by the Marvin warranty.

	PAGE
History	2
Part Identification – Wood Outswing Bi-Fold Door Head Jamb with Sill Options	3
Part Identification – Wood Outswing Bi-Fold Door 2, 3 and 5 Panel Jamb Detail	4
Part Identification – Clad Outswing Bi-Fold Door Head Jamb with Sill Options	5
Part Identification – Clad Outswing Bi-Fold Door 2, 3 and 5 Panel Jamb Detail	6
Bi-Fold Door Configurations	7
Parts – Hardware Configurations	8
Parts – Bi-Fold Doors	10
Weather Strip and Vinyl	17
Replacement Wood Parts	19
Replacement Parts – Sills	20
Panel Replacement	21
Energy Panels and Parts	22

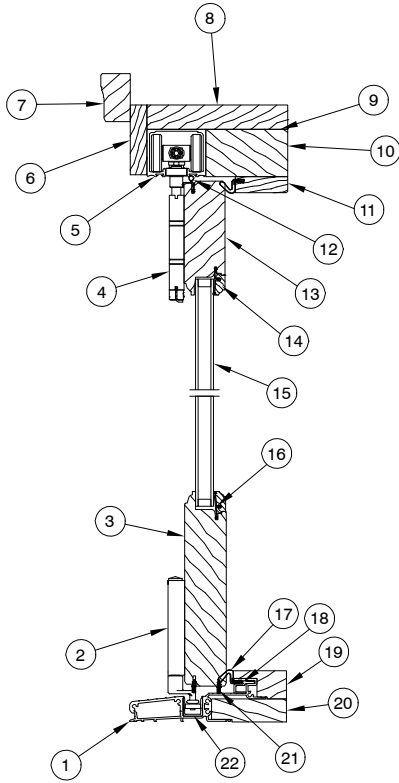
ATTENTION:

- Specification and technical data are subject to change without notice.
- Numbers listed in parentheses () are metric equivalents in millimeters rounded to the nearest whole number.

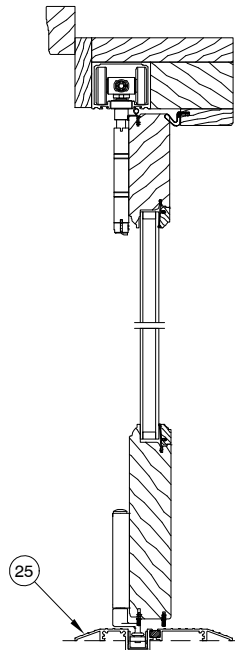
HISTORY

PRODUCED	UNIT TYPE	FEATURES OR CHANGES	DISCONTINUED
2006	Clad Outswing Bi-Fold Door	Unit features: 3/4" insulating glass, 5 1/2" jambs, CN68, 70 and 80 heights. Up to 8 panel configurations. E3 folding door hardware.	Present
2006	Wood Outswing Bi-Fold Door	Unit features: 3/4" insulating glass, 6 9/16" jambs, CN68, 70 and 80 heights. Up to 8 panel configurations. E3 folding door hardware.	Present
2014	Wood and Clad Outswing Bi-Fold Door	06/23/2014 – Added Contemporary panel and Contemporary handle options, retro sizes and beige weather strip options.	Present
2014	Wood and Clad Outswing Bi-Fold Door	10/27/2014 – Introduced Ogee as the new default interior profile.	Present
2019	Wood and Clad Outswing Bi-Fold Door	04/29/2019 – V1910 weather strip was replaced with V3020 panel weather strip and V3019 frame weatherstrip.	Present

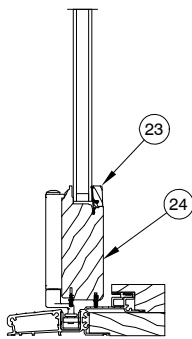
**WOOD OUTSWING BI-FOLD DOOR
 HEAD JAMB WITH SILL OPTIONS**



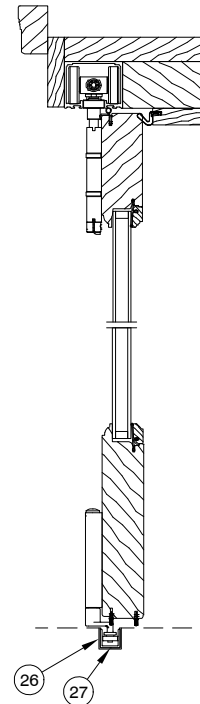
**Head Jamb
 w/Standard Sill And
 Traditional Bottom Rail**



**Head Jamb
 w/ ADA Sill**



**Standard Sill And
 Contemporary Bottom Rail**

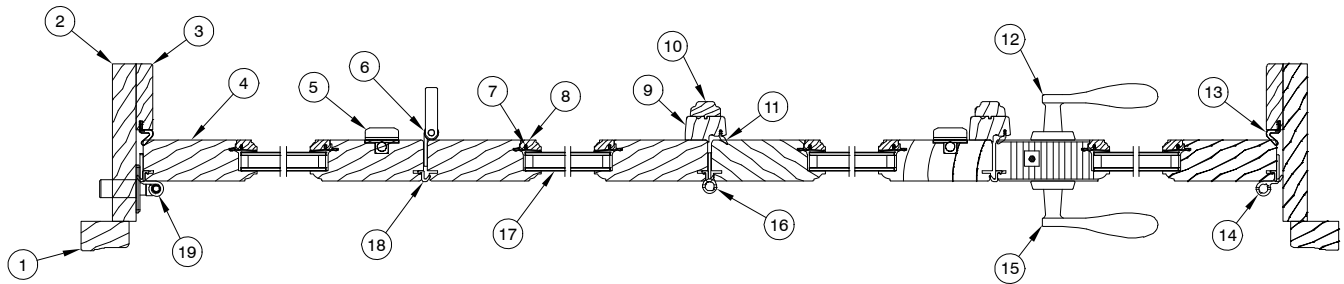


**Head Jamb
 w/ Floor Channel Sill**

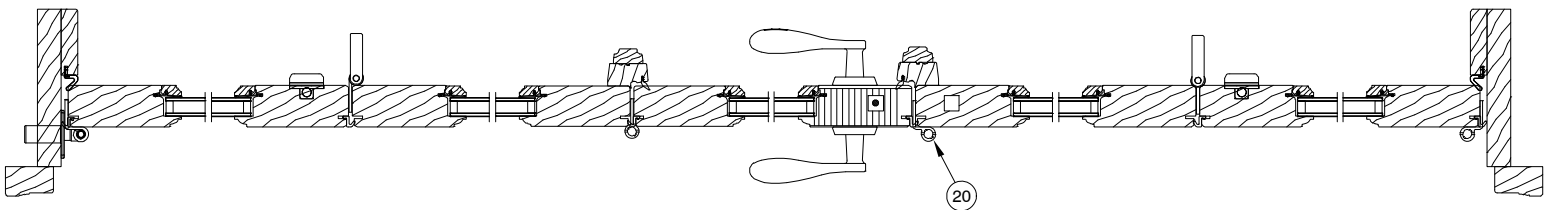
1. Bi-Fold sill, 6 9/16"
2. Panel Guide
3. Bottom Rail – Traditional
4. Panel Carrier
5. Head Jamb Track
6. Head Jamb Track Cover
7. Wood BMC
8. Head Jamb/Jamb
9. Connecting Barb
10. Head Jamb Support
11. Head Jamb/Jamb Stop
12. Panel Cover Weather Strip
13. Top Rail/Stile
14. Glazing Cap
15. Insulating Glass
16. Glazing Bead
17. Frame Weather Strip, V3019
18. Retainer Clip
19. Sill Nose
20. Sill Support Base
21. Bottom Rail Weather Strip
22. Channel Liner
23. Glazing Cap – Contemporary
24. Bottom Rail – 4 3/4" Contemporary
25. ADA Sill
26. Floor Channel
27. Floor Channel Liner

NOTE: Not to scale; specifications subject to change without notice.

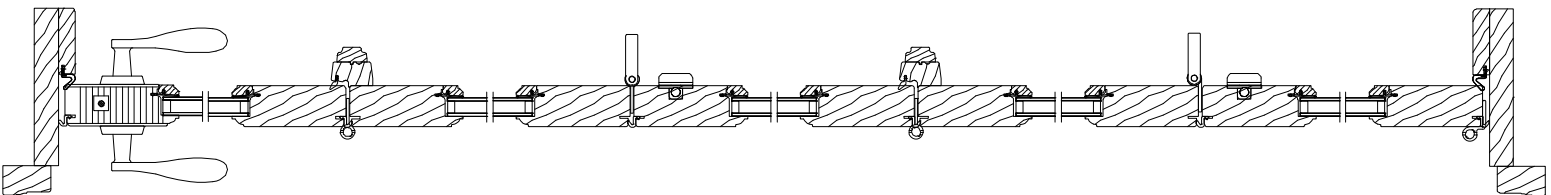
**WOOD OUTSWING BI-FOLD DOOR
 JAMB DETAIL**



4 Panel Operating Jamb – 3L1R



5 Panel Operating Jamb – 3L2R



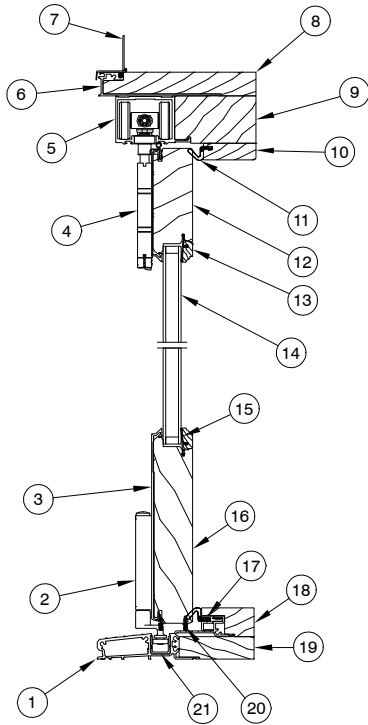
5 Panel Operating Jamb – 5R

NOTE: For more configurations see Marvin Architectural Detail Manual.

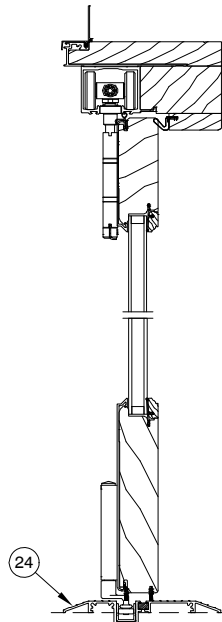
- | | |
|--------------------------------|---------------------------------|
| 1. Wood BMC | 14. End Pivots (Top and Bottom) |
| 2. Jamb/Head Jamb | 15. Exterior Handle |
| 3. Jamb/Head Stop | 16. Intermediate Carrier Set |
| 4. Stile/Top Rail | 17. Insulating Glass |
| 5. Drop Bolt | 18. Panel Weather Strip |
| 6. Half Offset Hinge Set | 19. Wall Pivot Hinge (Middle) |
| 7. Glazing Bead | 20. Left Carrier Set |
| 8. Glazing Cap | |
| 9. Mull Casing Base | |
| 10. Mull Casing Cover | |
| 11. Astragal Weather Strip | |
| 12. Interior Handle | |
| 13. Frame Weather Strip, V3019 | |

NOTE: Not to scale; specifications subject to change without notice.

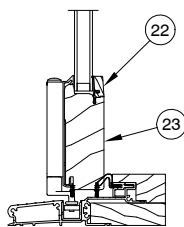
**CLAD OUTSWING BI-FOLD DOOR
 HEAD JAMB WITH SILL OPTIONS**



**Head Jamb
 w/Standard Sill And
 Traditional Bottom Rail**

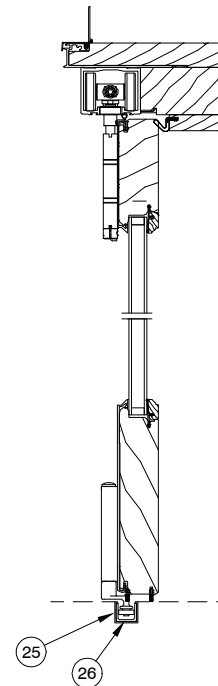


**Head Jamb
 w/ ADA Sill**



**Standard Sill And
 Contemporary Bottom Rail**

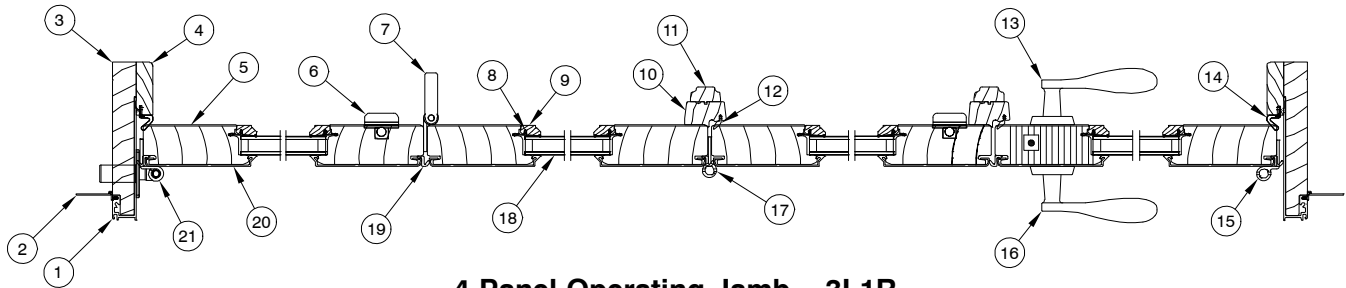
1. Bi-Fold sill, 6 9/16"
2. Panel Guide
3. Bottom Rail Cladding
4. Top Carrier
5. Head Jamb Track
6. Head Jamb/Jamb Cladding
7. Drip Cap/Nailing Fin
8. Head Jamb/Jamb
9. Head Jamb Support
10. Head Jamb/Jamb Stop
11. Frame Weather Strip, V3019
12. Top Rail/Stile
13. Glazing Cap
14. Insulating Glass
15. Glazing Bead
16. Bottom Rail Wood – Traditional
17. Retainer Clip
18. Sill Nose
19. Sill Support Base
20. Bottom Rail Weather Strip
21. Channel Liner
22. Glazing Cap – Contemporary
23. Bottom Rail – 4 3/4" Contemporary
24. ADA Sill
25. Floor Channel
26. Floor Channel Liner



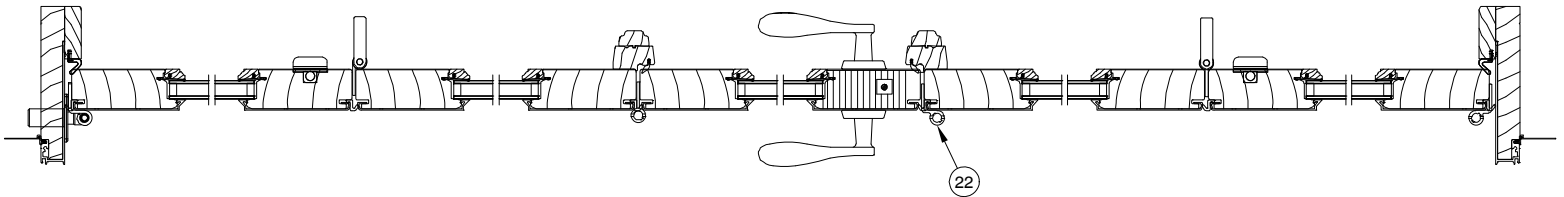
**Head Jamb
 w/ Floor Channel Sill**

NOTE: Not to scale; specifications subject to change without notice.

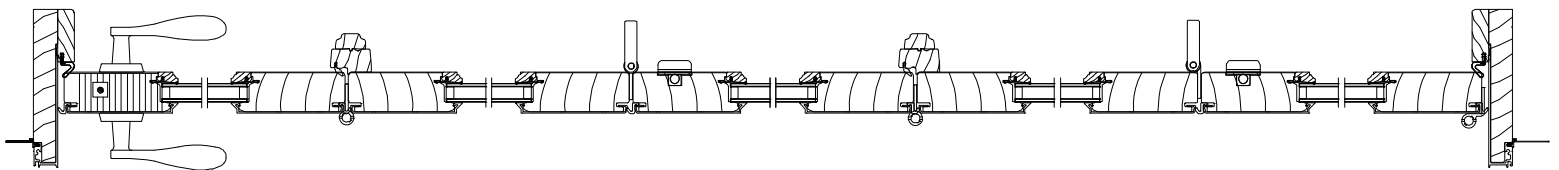
**CLAD OUTSWING BI-FOLD DOOR
 JAMB DETAIL**



4 Panel Operating Jamb – 3L1R



5 Panel Operating Jamb – 3L2R



5 Panel Operating Jamb – 5R

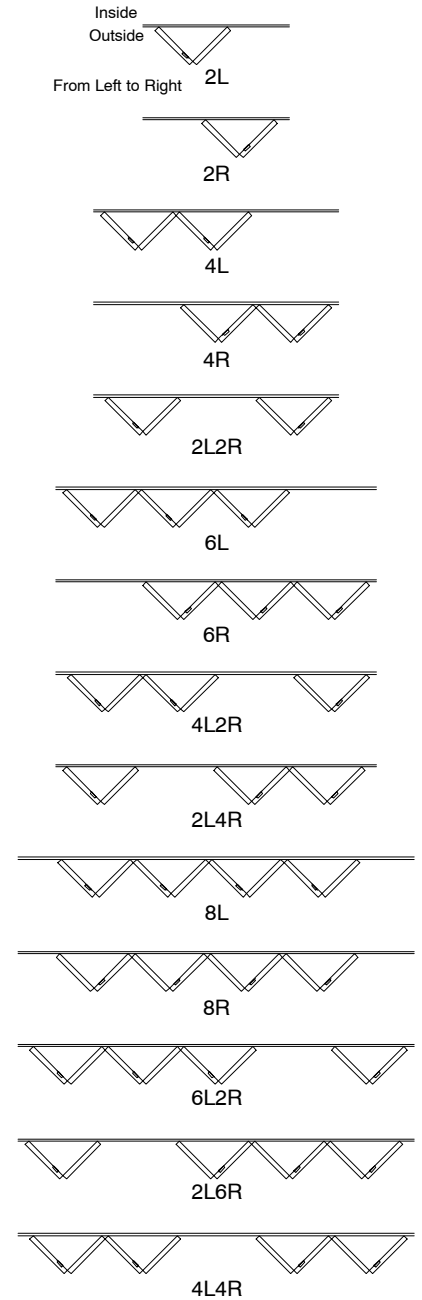
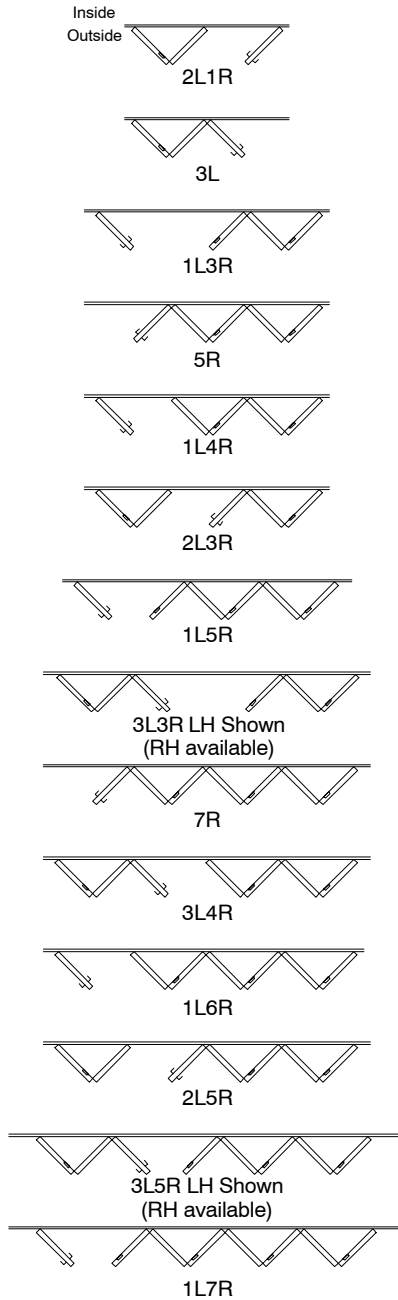
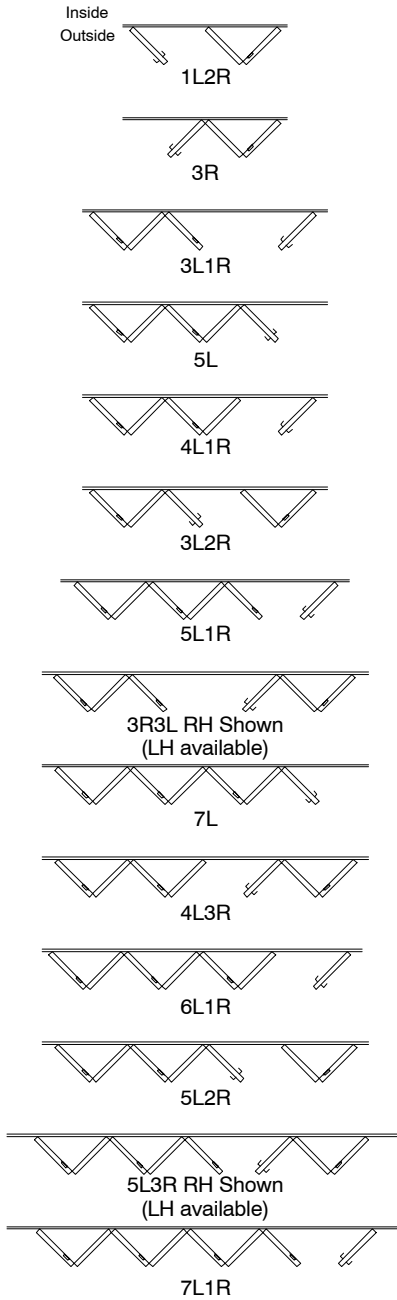
NOTE: For more configurations see Marvin Architectural Detail Manual.

- | | |
|--------------------------|--------------------------------|
| 1. Jamb/Head Jamb | 12. Astragal Weather Strip |
| 2. Nailing Fin | 13. Interior Handle |
| 3. Jamb/Head Jamb Stop | 14. Frame Weather Strip, V3019 |
| 4. Jamb/Head Jamb Stop | 15. End Pivot (Top & Bottom) |
| 5. Stile Wood | 16. Exterior Handle |
| 6. Drop Bolt | 17. Intermediate Carrier Set |
| 7. Half Offset Hinge Set | 18. Insulating Glass |
| 8. Glazing Bead | 19. Panel Weather Strip |
| 9. Glazing Cap | 20. Stile Cladding |
| 10. Astragal Base | 21. Wall Pivot (Middle) |
| 11. Astragal Cover | 22. Left Carrier Set |

NOTE: Not to scale; specifications subject to change without notice.

OUTSWING BI-FOLD DOOR – CONFIGURATIONS

Not Accessible from Exterior



NOTE: For replacements on these configurations see charts on the following pages.

PARTS – HARDWARE CONFIGURATIONS

Finsh	Part Numbers						
PVD Bronze	11102415	11102423	11102417	11102413	11102411	11102421	11102419
Stainless Steel	11102416	11102424	11102418	11102414	11102412	11102422	11102420
PVD Brass	10148303	10148304	10148308	10148309	10148307	10148306	10148305
	Pivot	Wall Pivot Set	Right Carrier	Left Carrier	Intermediate Carrier	Hinge Set	Half Offset Hinge Set
Code	Quantity						
2L*	1	1	1			1	
2R*	1	1		1		1	
2L1R	2	2	1			1	
1L2R	2	2		1		1	
3L	1	1			1		1
3R	1	1			1		1
3L1R	2	2			1		1
1L3R	2	2			1		1
4L*	1	1	1		1		2
2L2R*	2	2	1	1		2	
4R*	1	1		1	1		2
4L1R	2	2	1		1		2
1L4R	2	2		1	1		2
3L2R	2	2		1	1	1	1
2L3R	2	2	1		1	1	1
5L	1	1			2	1	1
5R	1	1			2	1	1
6L*	1	1	1		2	1	2
6R*	1	1		1	2	1	2
2L4R*	2	2	1	1	1	1	2
4L2R*	2	2	1	1	1	1	2
5L1R	2	2			2	1	1
1L5R	2	2			2	1	1
3L3R	2	2			2		2
7L	1	1			3	2	1
3L4R	2	2		1	2		3
7R	1	1			3	2	1
4L3R	2	2	1		2		3
5L2R	2	2		1	2	2	1
2L5R	2	2	1		2	2	1
6L1R	2	2		1	2	1	2
1L6R	2	2	1		2	1	2
5L3R	2	2			3	1	2
3L5R	2	2			3	1	2
6L2R*	2	2	1	1	2	2	2
2L6R*	2	2	1	1	2	2	2
7L1R	2	2			3	2	1
1L7R	2	2			3	2	1
8R*	1	1		1	3	2	2
8L*	1	1	1		3	2	2
4L4R*	2	2	1	1	2		4

* Not accessible from the exterior.

PARTS – HARDWARE CONFIGURATIONS

Finsh	Part Numbers						
	PVD Bronze Stainless Steel PVD Brass	11102402 BZ 11102403 SA	11102406 11102407 11102120	11102406 11102407 11102120	11102409 11102410 11102121	05700130	10148300 10148302 10148301
	Drop Bolt Cup	Lower Drop Bolt 8	Upper Drop Bolt 8 <= CN70	Upper Drop Bolt 16 > CN70	Multi Lock – box	Strike Jamb	Strike Panel
Code	Quantity						
2L*	2	1	1	1			
2R*	2	1	1	1			
2L1R	2	1	1	1	1		1
1L2R	2	1	1	1	1		1
3L	2	1	1	1	1	1	
3R	2	1	1	1	1	1	
3L1R	4	2	2	2	1		1
1L3R	4	2	2	2	1		1
4L*	4	2	2	2			
2L2R*	4	2	2	2			
4R*	4	2	2	2			
4L1R	4	2	2	2	1		1
1L4R	4	2	2	2	1		1
3L2R	4	2	2	2	1		1
2L3R	4	2	2	2	1		1
5L	4	2	2	2	1	1	
5R	4	2	2	2	1	1	
6L*	6	3	3	3			
6R*	6	3	3	3			
2L4R*	6	3	3	3			
4L2R*	6	3	3	3			
5L1R	6	3	3	3	1		1
1L5R	6	3	3	3	1		1
3L3R	6	3	3	3	1		1
7L	6	3	3	3	1	1	
3L4R	6	3	3	3	1		1
7R	6	3	3	3	1	1	
4L3R	6	3	3	3	1		1
5L2R	6	3	3	3	1		1
2L5R	6	3	3	3	1		1
6L1R	6	3	3	3	1		1
1L6R	6	3	3	3	1		1
5L3R	8	4	4	4	1		1
3L5R	8	4	4	4	1		1
6L2R*	8	4	4	4	1		1
2L6R*	8	4	4	4	1		1
7L1R	8	4	4	4	1		1
1L7R	8	4	4	4	1		1
8R*	8	4	4	4			
8L*	8	4	4	4			
4L4R*	8	4	4	4			

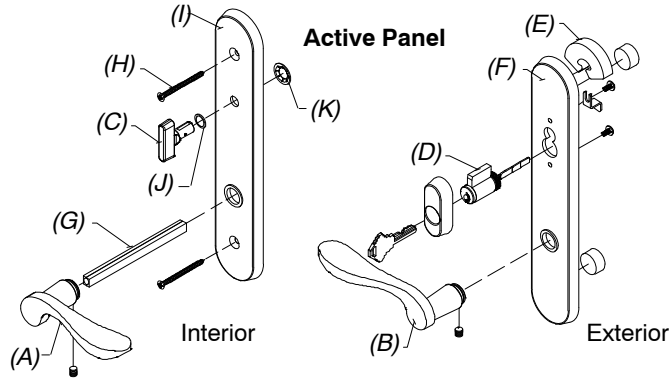
* Not accessible from the exterior.

NOTE: Default upper drop bolt length 8" (203) for heights up to CN7/0, 16" (406) for heights over CN 7/0.



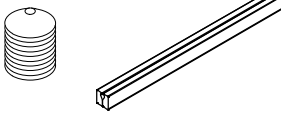

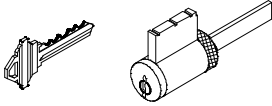
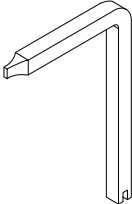
When ordering replacement parts specify:

1. type of unit;
2. part number;
3. description.

ILLUSTRATIONS (not to scale)



<p>Handle Assembly, Active Panel Mortise lock and Multi-point lock systems (Schlage "C" keyway) Includes: 1 - Interior lever (A) with 00142006 spindle, escutcheon plate and hardware 1 - Exterior lever (B) with escutcheon plate and hardware 1 - Thumb turn (C) with hardware 1 - Keyed cylinder (D) with housing and hardware 1 - Exterior escutcheon plate gasket (E) 1 - Exterior escutcheon plate (F) 1 - Two piece spindle (G) 2 - #10-32 x 2 1/8" Phillips ovalhead machine screws (H) 1 - Interior escutcheon plate (I) 1 - Thumb turn washer (J) 1 - Thumb turn push nut (K) 2 - Keys</p>	<p>Satin Taupe Antique Brass White Satin Chrome Oil Rubbed Bronze ORBZ PVD Brass PVD Satin Nickel PVD Dark Bronze Polished Chrome Matte Black</p>	<p>10830304 10830306 10830310 10830302 10148111 10830300 10830324 10830421 10830330 10830308 10830450</p>
<p>Thumb Turn (C) NOTE: For each thumb turn, order one thumb turn washer -00143045 (J) and one thumb turn push nut 00143010 (K).</p>	<p>Satin Taupe Antique Brass White Oil Rubbed Bronze ORBZ PVD Brass PVD Satin Nickel PVD Satin Chrome Dark Bronze</p>	<p>00142061 00142055 00142058 00142062 10148428 00142054 00142063 00142064 10148426</p>

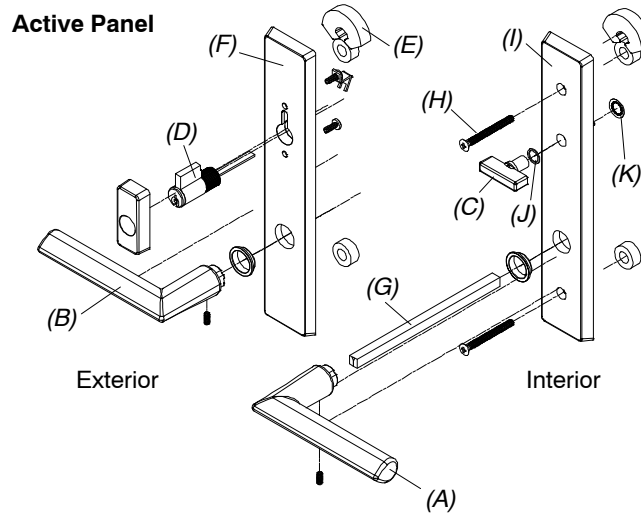
ILLUSTRATION NOT TO SCALE	DESCRIPTION	OPER./COLOR	PART NO.
	Lug seals		00142046
	#10-32 x 2 1/8" Phillips ovalhead machine screws	Satin Taupe Antique Brass White Satin Chrome Oil Rubbed Bronze ORBZ PVD Brass PVD Satin Nickel PVD Dark Bronze	11800616 00143038 00143036 10840031 10840032 11800160 11800615 NA 11800654
	Spindle Kit (Truth & Ashland) <i>Includes:</i> 1 – 2 piece. spindle, 4 3/8" 2 – Set screws		02100942
	Lever Bushing, Swinging Handle Set – Traditional	Clear Gray Gold Natural Black	02062201 10148448 10148447 02062202 10148020
	Key Cylinder, Lock (Schlage "C" keyway) For service replacement only. <i>NOTE: For Keyed Alike orders, use program C87P2.</i> <i>BS, ORBZ PVD, TP, WH, AB=Brass Face</i> <i>All other Marvin finishes=Chrome Face</i>	Brass Face Chrome Face	10830211 10830208
	Construction Handle		10830451

NOTE: Dark Bronze screws are used with Antique Brass and Oil Rubbed Bronze PVD

When ordering replacement parts specify:

1. type of unit;
2. part number;
3. description.

ILLUSTRATIONS (not to scale)



<p>Handle Assembly, Active Panel Mortise lock and Multi-point lock systems (Schlage "C" keyway) Includes: 1 – Interior lever (A) with 10148414 spindle, escutcheon plate and hardware 1 – Exterior lever (B) with escutcheon plate and hardware 1 – Thumb turn (C) with hardware 1 – Keyed cylinder (D) with housing and hardware 1 – Exterior escutcheon plate gasket (E) 1 – Exterior escutcheon plate (F) 1 – Two piece spindle (G) 2 – M5 x 55mm Phillips ovalhead machine screws (H) 1 – Interior escutcheon plate (I) 1 – Thumb turn washer (J) 1 – Thumb turn push nut (K) 2 – Keys</p>	<p>TP ORBZ PVD SN PVD DK BZ</p>	<p>11102150 11102151 11102152 11102156</p>
<p>Thumb Turn (C) NOTE: For each thumb turn, order one thumb turn washer –10148423 (J) and one thumb turn push nut 10148424(K).</p>	<p>TP ORBZ PVD SN PVD DK BZ</p>	<p>10148425 10148428 10148427 10148426</p>


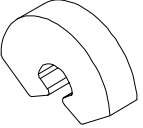

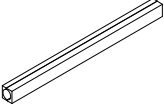
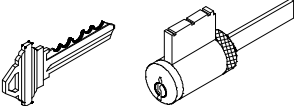


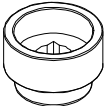

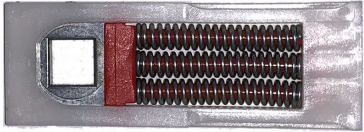
ILLUSTRATION NOT TO SCALE	DESCRIPTION	OPER./COLOR	PART NO.
	Gasket Post		10148404
	Gasket – Top Backplate		10148405
	M5 x 55mm Phillips ovalhead machine screw	Satin Taupe Dark Bronze ORB PVD Satin Nickel PVD	10148400 10148401 10148402 10148403
	Spindle Kit (HOPPE) <i>Includes:</i> 1 – 2 piece. spindle, 4 3/8" 2 – Set screws		10148414
	Key Cylinder, Lock (Schlage “C” keyway) For service replacement only. <i>NOTE: For Keyed Alike orders, use program C87P2.</i> <i>BS, ORBZ PVD, TP, WH, AB=Brass Face</i> <i>All other Marvin finishes=Chrome Face</i>	Brass Face Chrome Face	10830211 10830208
	Set Screw for Handle Assembly See Spindle kit		NA
	Lever Bushing, Swinging Handle Set – Contemporary	Gray Natural Black	10148448 02062202 10148020
	3/4" Handle Extension Requires 3/4" Spindle Extension	Satin Taupe Dark Bronze	10148419 10148420
	3/4" Spindle Extension (HOPPE)		10148415
	Spring Cartridge, Swinging Handle Set – Contemporary		10830452

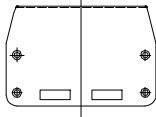
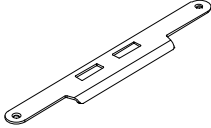
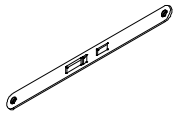
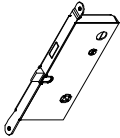
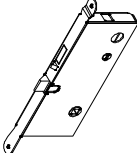
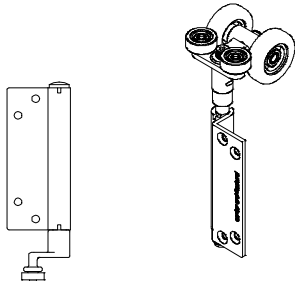
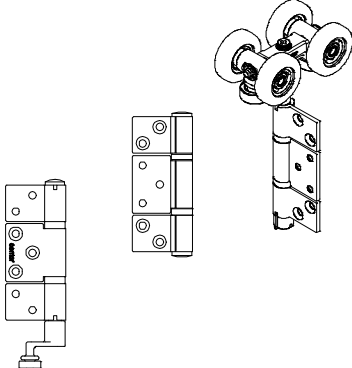
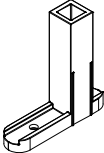
ILLUSTRATION NOT TO SCALE	DESCRIPTION	OPER./COLOR	PART NO.
	Strike Plate, Jamb Includes: 1 - Jamb strike plate 4 - #8x1" Phillips flathead screws	Satin Chrome ORBZ PVD Brass PVD	10148302 10148300 10148301
	Strike Plate, Panel - Includes: 1 - Panel strike plate 2 - #8x1" Phillips flathead screws (match finish of strike plate)	Stainless Steel Antique Brass ORBZ PVD Brass PVD	05700049 05700044 05700117 10148176
	Cover Plate, Active Panel - Mortise Lock or Multi-Point Lock* 1/17/00 - Present (Amerock) Includes: 1 - Cover plate 2 - #8x1" Phillips flathead wood screws	Stainless Steel Antique Brass ORBZ PVD Brass PVD	05700306 05700307 05700308 10148179
	Mortise Lock, Active Single-Point Lock (latch, dead bolt only) 1/17/00 - Present (Amerock) Includes: 2 - #8x3/4" Phillips flathead screws		05700129
	Mortise Lock, Active Multi-Point Lock (latch, dead bolt and head/foot shoot bolts) 1/17/00 - Present (Amerock) Includes: 2 - #8x3/4" Phillips flathead screws		05700130
	Carrier Set Includes: 1 - Top carrier 1 - Bottom guide 8 - #8x1 1/2" Phillips flathead screws	Stainless Steel Bronze PVD Brass PVD	Left 11102414 11102413 10148309 Right 11102418 11102417 10148308
	Concealed Intermediate Carrier Set Includes: 1 - Top carrier 1 - Center hinge 1 - Bottom guide 21 - #8x1 1/2" Phillips flathead screws	Stainless Steel Bronze PVD Brass PVD	11102412 11102411 10148307
	Shoot Bolt Guide Active Panels - w/Multi-Point (2 Shoot Bolt Guides are required) 1 - Shoot bolt guide (10815186) 1 - #8x1 1/2" Phillips panhead wood screw (11800766)		10815199

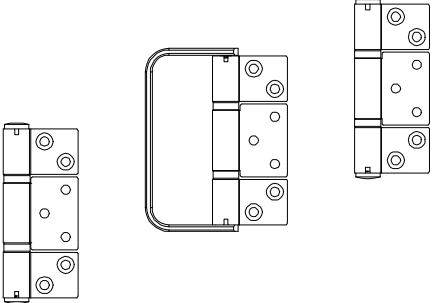
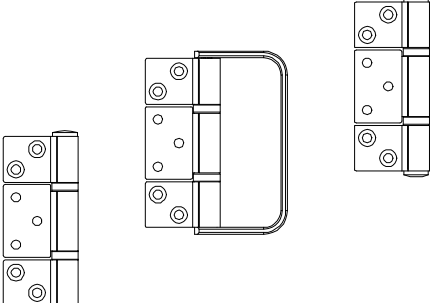
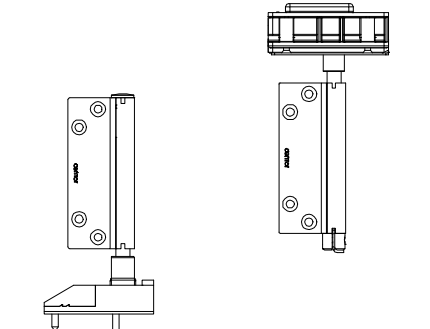
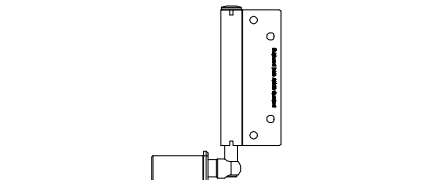
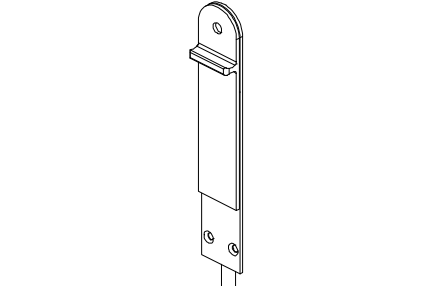
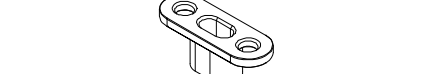
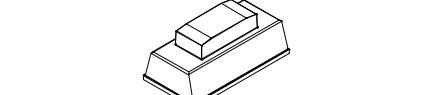
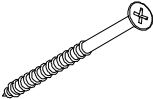
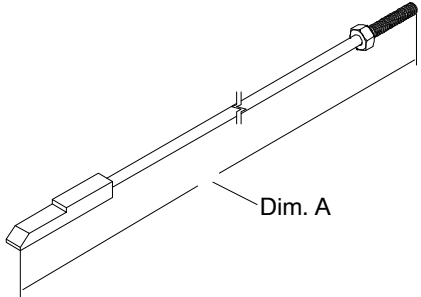
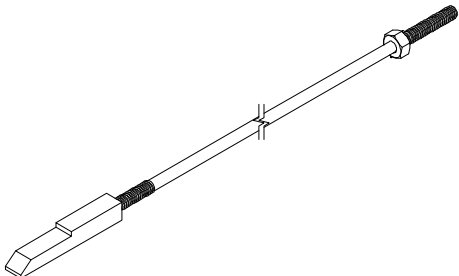
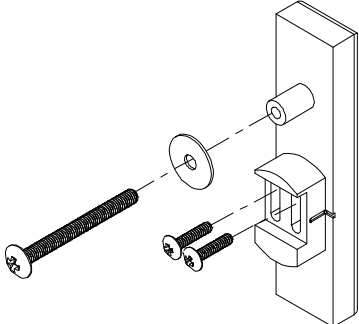




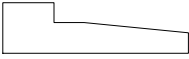
ILLUSTRATION NOT TO SCALE	DESCRIPTION	OPER./COLOR	PART NO.
	<p>Hinge Set <i>Includes:</i> 1 – Top hinge 1 – Center hinge with handle 1 – Bottom hinge 21 – #8x1 1/2" Phillips flathead screws</p>	<p>Stainless Steel Bronze PVD Brass PVD</p>	<p>11102422 11102421 10148306</p>
	<p>Half Offset Hinge Set <i>Includes:</i> 1 – Top hinge 1 – Center hinge with handle 1 – Bottom hinge 21 – #8x1 1/2" Phillips flathead screws</p>	<p>Stainless Steel Bronze PVD Brass PVD</p>	<p>11102420 11102419 10148305</p>
	<p>Concealed Pivot Hinge Set <i>Includes:</i> 1 – Top pivot 1 – Bottom pivot 8 – #8x1 1/2" Phillips flathead screws 1 – #2 Square drive 1 – Bottom Pivot Block w/#7x1" Pan head screw 1 – Hinge cap w/#7x1" Phillips flathead screws and #7x1" Pan head screw</p>	<p>Stainless Steel Bronze PVD Brass PVD</p>	<p>11102416 11102415 10148303</p>
	<p>Wall Pivot Hinge <i>Includes:</i> 1 – Jamb cup 1 – Pivot rod 1 – Hinge 1 – #2 Square drive and strike bolt 6 – #8x1 1/2" Phillips flathead screws</p>	<p>Stainless Steel Bronze PVD Brass PVD</p>	<p>11102424 11102423 10148304</p>
	<p>8" Drop Bolt <i>Includes:</i> 3 – #7x1 1/4" Phillips flathead screws</p>	<p>Brushed Metallic ORBZ Brass PVD</p>	<p>11102407 11102406 11102120</p>
	<p>16" Drop Bolt <i>Includes:</i> 3 – #7x1 1/4" Phillips flathead screws</p>	<p>Brushed Metallic ORBZ Brass PVD</p>	<p>11102410 11102409 11102121</p>
	<p>24" Drop Bolt <i>Includes:</i> 3 – #7x1 1/4" Phillips flathead screws</p>	<p>Brushed Metallic ORBZ Brass PVD</p>	<p>11102453 11102452 11102454</p>
	<p>Drop Bolt Cup</p>	<p>Satin Bronze</p>	<p>11102403 11102402</p>
	<p>Magnetic Door Catch <i>Includes:</i> 2 – Magnetic Door Catches</p>	<p>Black</p>	<p>11102443</p>

ILLUSTRATION NOT TO SCALE	DESCRIPTION	OPER./COLOR	PART NO.												
	<p>Installation Screw Package; Strike Plate(s) at head jamb, or locking jamb</p> <p>#8 x 2 1/2" Flathead wood screw</p> <p>Package of 4 Package of 4 Package of 4</p>	<p>Stainless Steel Brass PVD Antique Brass</p>	<p>11882349 11882343 11882347</p>												
	<p>Locking Rod Assembly, Top – Multi-Point Lock</p> <p>Solid stainless steel rod with 1/4" – 20 threads</p> <p>NOTE: For special heights give dimension A.</p> <table border="1" data-bbox="667 751 992 961"> <thead> <tr> <th>Height</th> <th>Top Locking Rod Length</th> </tr> </thead> <tbody> <tr> <td>6/6 CN</td> <td>35 7/16"</td> </tr> <tr> <td>6/8 CN</td> <td>37 15/16"</td> </tr> <tr> <td>7/0 CN</td> <td>41 15/16"</td> </tr> <tr> <td>8/0 CN</td> <td>51 7/16"</td> </tr> <tr> <td>Lineal</td> <td>75 7/16"</td> </tr> </tbody> </table>	Height	Top Locking Rod Length	6/6 CN	35 7/16"	6/8 CN	37 15/16"	7/0 CN	41 15/16"	8/0 CN	51 7/16"	Lineal	75 7/16"	<p>Stainless Steel</p>	<p>10815143 10815139 10815140 10815141 10815142</p>
Height	Top Locking Rod Length														
6/6 CN	35 7/16"														
6/8 CN	37 15/16"														
7/0 CN	41 15/16"														
8/0 CN	51 7/16"														
Lineal	75 7/16"														
	<p>Locking Rod Assembly, Bottom for Multi-Point Lock</p> <p>Solid stainless steel rod with 1/4" – 20 threads</p> <table border="1" data-bbox="667 1129 992 1304"> <thead> <tr> <th>Height</th> <th>Bottom Locking Rod Length</th> </tr> </thead> <tbody> <tr> <td>CN 6-6R ht*</td> <td>34 9/32"</td> </tr> <tr> <td>CN 6-8 ht</td> <td>34 9/32"</td> </tr> <tr> <td>CN 7-0 ht</td> <td>34 9/32"</td> </tr> <tr> <td>CN 8-0 ht</td> <td>34 9/32"</td> </tr> </tbody> </table>	Height	Bottom Locking Rod Length	CN 6-6R ht*	34 9/32"	CN 6-8 ht	34 9/32"	CN 7-0 ht	34 9/32"	CN 8-0 ht	34 9/32"	<p>Stainless Steel</p>	<p>10815138</p>		
Height	Bottom Locking Rod Length														
CN 6-6R ht*	34 9/32"														
CN 6-8 ht	34 9/32"														
CN 7-0 ht	34 9/32"														
CN 8-0 ht	34 9/32"														
	<p>Construction Lock Assembly</p> <p>For Marvin residential swinging and sliding doors with standard locks.</p> <p><i>Includes:</i></p> <ul style="list-style-type: none"> 1 – Construction Lock Cover 1 – Construction Lock Hole Cover 1 – Washer 2 – #6-32 X 5/8" Phillips TH screws 1 – #10-32 X 2" Phillips TH screw 	<p>Each 25/Box</p>	<p>18450200 18450198</p>												

WEATHER STRIP AND VINYL

When ordering replacement weather strip or vinyl parts, specify:

1. quantity;
2. length;
3. part number;
4. description.

ILLUSTRATION <i>NOT TO SCALE</i>	DESCRIPTION	LENGTH	COLOR	PART NUMBER
	Weather Strip, Panel Cover V018	150" 150"	BG BK	11197799 11197798
	Weather Strip, Pile V1911	Lineal	GY	11195400
	Weather Strip, Astragal V1138	Lineal	BG BK	15910499 15910799
	Weather Strip, Panel V1897	Lineal	BG BZ	11195201 11195200
	Dust Block, Panel V1962	Lineal	GY	11195303
	Sill Gasket		BK	11102404

OUTSWING BI-FOLD DOOR

When ordering replacement wood parts specify:

1. length;
2. color.

	Wood	Clad
Frame Weather Strip, V3019	V3019	V3019

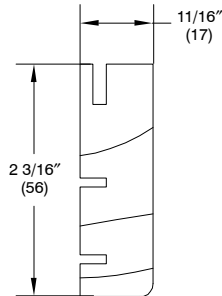


V3019

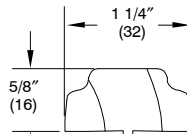
REPLACEMENT WOOD PARTS

OUTSWING BI-FOLD DOOR

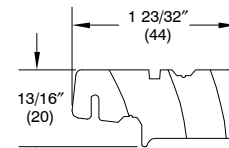
	Wood	Clad
Jamb Stop	W10142	W10142
Mull Casing Base	W1455	W1455
Mull Casing Cover	W7554	W7554



W10142 – Jamb Stop



W7554 – Mull Casing Cover



W1455 – Mulling Casing Base

TO ORDER REPLACEMENT WOOD PARTS

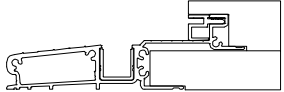

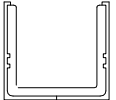
When ordering replacement wood parts specify:

1. profile number;
2. rough opening;
3. handing;
4. length;
5. finish.

REPLACEMENT PARTS – SILLS

When ordering replacement parts specify:

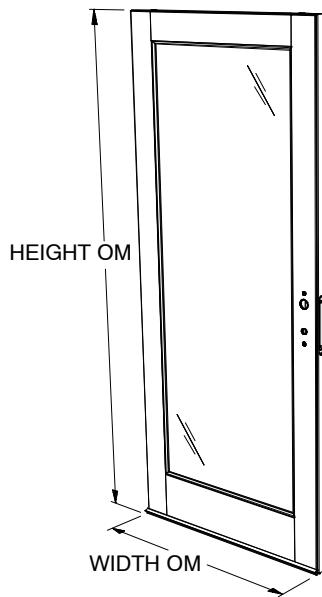
1. profile number;
2. rough opening;
3. length;
4. handing;
5. finish (where applicable).

ILLUSTRATION <i>NOT TO SCALE</i>	DESCRIPTION	LENGTH	OPER./COLOR	PART NUMBER
	Bi-Fold Sill – 6 9/16" Extruded Aluminum, Douglas Fir Cap	111"	BZ Anodized	11195500
		147"		11195501
		222"		11195503
		147"	Clear Anodized	11195502
222"	11195504			
	6 9/16" Thermally Broken ADA Sill	147"	BZ	11102444
		183"		11102447
		222"		11102446
		294"		11102445
147"	Clear	11195523		
183"	11195524			
222"	11195525			
294"	11195526			
	Floor Channel <i>Includes: Bronze Anodized Channel PVC insert, black</i>	222"		11195509

ORDERING REPLACEMENT PANELS FOR THE WOOD AND CLAD OUTSWING BI-FOLD DOOR

To order replacement panels specify:

1. OM of panel;
NOTE: OM of panel does not include astragal, or sweep.
2. active, or folding;
 - a. active – multi-point lock
 - b. panel style
3. handing per bi-fold configuration (from left exterior);
4. glazing;
5. finish;
6. glazing bead profile (should include all standard options).
 - a. ovolo
 - b. ogee
 - c. square



**Wood Active Panel
Exterior View**



**Clad Active Panel
Exterior View**

NOTE: Weather Strip is included with all panels (beige & bronze) and pile weather strip.

Active panels include multi-point lock system.

Folding panels include panel cover (beige, bronze) and dust block.

ORDERING ENERGY PANELS FOR SINGLE GLAZED WOOD OUTSWING BI-FOLD DOOR

If you are replacing an existing energy panel, determine the outside measurement of the existing energy panel. Find the sizes that correspond to the width and height indicated on the following chart. Energy panels are available for the single glazed Wood Outswing Bi-Fold Doors. Aluminum surrounds are available in bronze, or stone white.

When ordering energy panels specify:

1. size; If there is no existing EP from which to obtain the OM of the panel, determine the size of the EP by using the conversion chart below. The daylight opening is the measurement of the visible glass.
2. color of surround;
3. glass type.

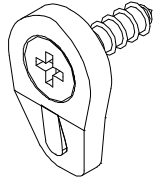
Single Glazed				
Wood Outswing Bi-Fold Doors manufactured 2006 – Present				
Daylight Opening to OM of EP				
Daylight Width + 1 3/8" = OM Width of EP				
Daylight Height + 1 3/8" = OM Height of EP				
WIDTH			HEIGHT	
SIZE	(65 ht.)	OM-WIDTH	SIZE	OM-HEIGHT
CN 26	(65 ht.)	19 15/32"		
CN 30	(65 ht.)	25 15/32"		
CN 16	(66R ht.)	12 7/8"	CN 66R	65"
CN 26R		20 5/32"		
CN 30R		26 5/32"		
CN 20		14 31/32"	CN 68	67 1/2"
CN 26		20 31/32"	CN 70	71 1/2"
CN 28		22 31/32"	CN 80	81"
CN 30		26 31/32"		

ENERGY PANEL PARTS

Energy panels are attached with turn buttons. Turn button styles may vary depending on current stock. You will receive the most current style in the color of your choice. (Discontinued black turn buttons will be replaced by brown.)

When ordering energy panel parts specify:

1. quantity;
2. description;
3. color;
4. part number.

ILLUSTRATION <i>NOT TO SCALE</i>	DESCRIPTION	COLOR	PART NUMBER	
	Turn Button All turn buttons include a #8x3/4" SS full thread screw		<u>Each</u>	<u>Pkg of 50</u>
		SW	11869294	11869314
		CL	11869309	11869315
		PB	11869292	11869312
		BZ	11869291	11869311
		BN	11869293	11869313