

MISCELLANEOUS MOULDINGS, EXTRUSIONS & ACCESSORIES

Table of Contents

| | PAGE |
|---|-------------|
| Interior Wood Parts | 2 |
| Exterior Wood Parts | 17 |
| Discontinued Wood Parts (LA) | 21 |
| Accessories | |
| Installation Accessories | 25 |
| Discontinued Installation Accessories (LA) | 38 |
| Screen Accessories | 39 |
| Aluminum Extrusion Profiles | 40 |
| Discontinued Aluminum Extrusion Profiles (LA) | 73 |
| End Caps and Lineal Caps | 75 |
| Energy Panels, Turn Buttons | 82 |

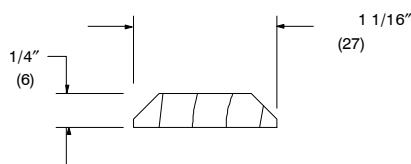

W1241, Mullion Trim

Used on Ultimate Casement/Awning, Ultimate Casement Round Top, Ultimate Tilt Turn and Hopper, Polygon, Round Top

| Finish | Wood Species | | | | | | |
|-----------------|--------------|-------------|--------------|---------------|-----------------------|-----------------|------------------|
| | Pine PN 46" | Pine PN 84" | Pine PN 120" | Cherry PN 84" | VG Douglas Fir PN 84" | Mahogany PN 84" | White Oak PN 84" |
| Bare | 32249048 | 32249084 | 32249099 | CH32249084 | DF32249084 | MA32249084 | WK32249084 |
| Clear | CL32249048 | CL32249084 | CL32249099 | CCH32249084 | CDF32249084 | CMA32249084 | CWK32249084 |
| Prime | 38612248 | 38612284 | 38612299 | - | - | - | - |
| Honey | SB32249048 | SB32249084 | SB32249099 | SBCH32249084 | SBDF32249084 | SBMA32249084 | SBWK32249084 |
| Wheat | SA32249048 | SA32249084 | SA32249099 | SACH32249084 | SADF32249084 | SAMA32249084 | SAWK32249084 |
| Cabernet | SE32249048 | SE32249084 | SE32249099 | SECH32249084 | SEDF32249084 | SEMA32249084 | SEWK32249084 |
| Leather | SD32249048 | SD32249084 | SD32249099 | SDCH32249084 | SDDF32249084 | SDMA32249084 | SDWK32249084 |
| Hazelnut | SC32249048 | SC32249084 | SC32249099 | SCCH32249084 | SCDF32249084 | SCMA32249084 | SCWK32249084 |
| Espresso | SF32249048 | SF32249084 | SF32249099 | SFCH32249084 | SFDF32249084 | SFMA32249084 | SFWK32249084 |

W1242, Mullion Trim (Interior)

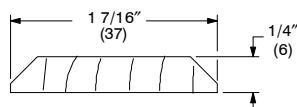

Used to cover 3/8" MRF on these product categories: Ultimate and Ultimate Wood Double Hung, Ultimate and Ultimate Wood Double Hung Magnum, Round Top, Polygon, Ultimate and Ultimate Wood Casement, Ultimate and Ultimate Wood Casement Round Top, Ultimate Glider and Ultimate Wood Glider Disc LA PRE 2/26/2018.

| Finish | Wood Species | | | | | | |
|-----------------|-----------------|--------------|--------------|-------------------|---------------------------|---------------------|----------------------|
| | Pine PN 85 1/2" | Pine PN 120" | Pine PN 150" | Cherry PN 85 1/2" | VG Douglas Fir PN 85 1/2" | Mahogany PN 85 1/2" | White Oak PN 85 1/2" |
| Bare | 32249184 | 32249199 | 32249198 | CH32249184 | DF32249184 | MA32249184 | WK32249184 |
| Clear | CL32249184 | CL32249199 | CL32249198 | CCH32249184 | CDF32249184 | CMA32249184 | CWK32249184 |
| Prime | 38612084 | 38612099 | 38612098 | - | - | - | - |
| Honey | SB32249184 | SB32249199 | SB32249198 | SBCH32249184 | SBDF32249184 | SBMA32249184 | SBWK32249184 |
| Wheat | SA32249184 | SA32249199 | SA32249198 | SACH32249184 | SADF32249184 | SAMA32249184 | SAWK32249184 |
| Cabernet | SE32249184 | SE32249199 | SE32249198 | SECH32249184 | SEDF32249184 | SEMA32249184 | SEWK32249184 |
| Leather | SD32249184 | SD32249199 | SD32249198 | SDCH32249184 | SDDF32249184 | SDMA32249184 | SDWK32249184 |
| Hazelnut | SC32249184 | SC32249199 | SC32249198 | SCCH32249184 | SCDF32249184 | SCMA32249184 | SCWK32249184 |
| Espresso | SF32249184 | SF32249199 | SF32249198 | SFCH32249184 | SFDF32249184 | SFMA32249184 | SFWK32249184 |

Parts below are for Product Categories: Ultimate Double Hung, Ultimate Double Hung Magnum, Round Top, Polygon, Ultimate Glider

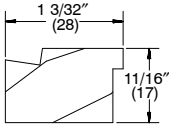
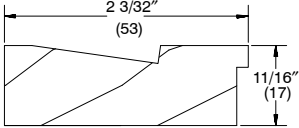
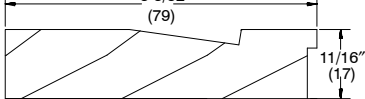
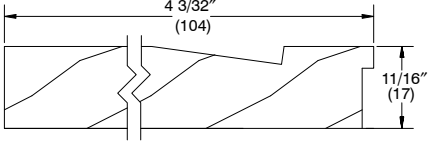
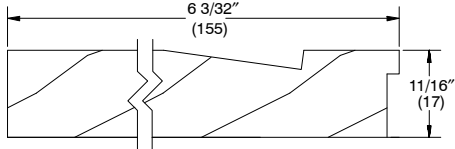
| ILLUSTRATION NOT TO SCALE | DESCRIPTION | PROFILE NUMBER |
|---|----------------------------------|--|
|  | 1" Jamb Extension – W2109 | <u>96" (2438)</u> 30808596 Bare 38278596 Primed <u>120" (3048)</u> 30808598 Bare 38278598 Primed |
|  | 2" Jamb Extension – W2059 | <u>96" (2438)</u> 30808096 Bare <u>120" (3048)</u> 30808098 Bare 38272398 Primed <u>144" (3658)</u> 30802399 Bare |
|  | 3" Jamb Extension – W1071 | <u>96" (2438)</u> 30802996 Bare <u>120" (3048)</u> 30802998 Bare 38276798 Primed |
|  | 4" Jamb Extension – W1069 | <u>96" (2438)</u> 30801896 Bare <u>120" (3048)</u> 30801898 Bare |
|  | 6" Jamb Extension – W1067 | <u>96" (2438)</u> 30801996 Bare <u>120" (3048)</u> 30801998 Bare |

Parts below are for Product Categories: Ultimate Casement, Ultimate Casement Round Top and Polygon

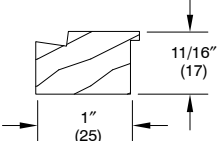
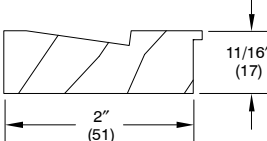
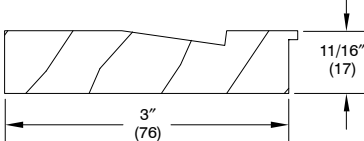
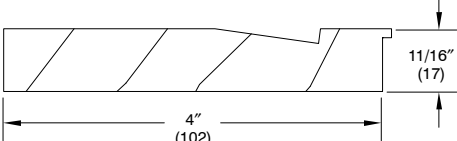
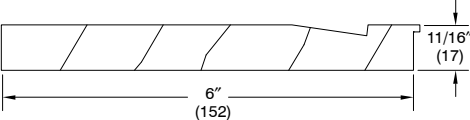
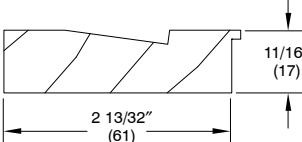
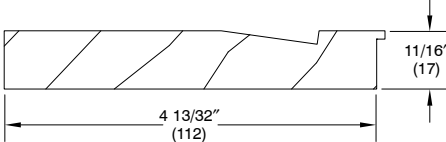
| ILLUSTRATION NOT TO SCALE | DESCRIPTION | PROFILE NUMBER |
|---|--|--|
|  | 1" Jamb Extension – W10168 | <u>120" (3048)</u> 30394398 Bare 38394398 Primed |
|  | 2" Jamb Extension – W10170 | <u>120" (3048)</u> 30398798 Bare 38397798 Primed |
|  | 3" Jamb Extension – W10171 | <u>120" (3048)</u> 30398998 Bare 38397998 Primed |
|  | 4" Jamb Extension – W10172 | <u>120" (3048)</u> 30399798 Bare 38399798 Primed |
|  | 6" Jamb Extension – W9923 | <u>120" (3048)</u> 30399298 Bare |
|  | 2 13/32" Jamb Extension – W9894 2 3/16" to 4 9/16" | <u>120" (3048)</u> 30399098 Bare |
|  | 4 13/32" Jamb Extension – W9921 2 3/16" to 6 9/16" | <u>120" (3048)</u> 30399498 Bare |

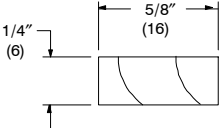
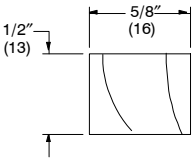
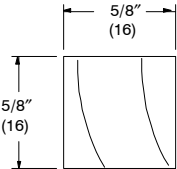
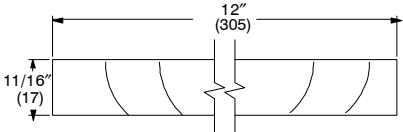
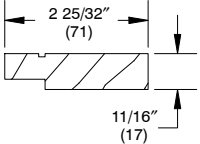
| ILLUSTRATION NOT TO SCALE | DESCRIPTION | PROFILE NUMBER |
|---|---|--|
|  | <p>Jamb Extension—From 4 9/16" to 4 13/16" W6010</p> <p>Ultimate Double Hung: UWDH, UWSH, UWDHP, UWDHTR, UDHDISC62915 products, USHDISC62915</p> <p>Ultimate Double Hung Magnum: WUDHM, WUSHM, UDHDISC62915 products, USHDISC62915</p> <p>Round Top: UWDHRT, CRTUDH, UDHRTOPERDISC62915, UWDHMRT, UDHMRTDISC62915,</p> <p>Polygon: UWDHPOLY, UDHPOLY</p> <p>Ultimate Glider: All Unit Types</p> | <p>96" (2438) 30808196 Bare 38278196 Primed</p> <p>120" (3048) 30808198 Bare 38278198 Primed</p> |
|  | <p>Jamb Extension— From 4 9/16" to 5 1/16" W6011</p> <p>Ultimate Double Hung: UWDH, UWSH, UWDHP, UWDHTR, UDHDISC62915 products, USHDISC62915</p> <p>Ultimate Double Hung Magnum: WUDHM, WUSHM, UDHDISC62915 products, USHDISC62915</p> <p>Round Top: UWDHRT, CRTUDH, UDHRTOPERDISC62915, UWDHMRT, UDHMRTDISC62915,</p> <p>Polygon: UWDHPOLY, UDHPOLY</p> <p>Ultimate Glider: All Unit Types</p> | <p>96" (2438) 30808296 Bare 38278296 Primed</p> <p>120" (3048) 30808298 Bare 38278298 Primed</p> |
|  | <p>Jamb Extension – From 4 9/16" to 5 3/16" W6012</p> <p>Ultimate Double Hung: UWDH, UWSH, UWDHP, UWDHTR, UDHDISC62915 products, USHDISC62915</p> <p>Ultimate Double Hung Magnum: WUDHM, WUSHM, UDHDISC62915 products, USHDISC62915</p> <p>Round Top: UWDHRT, CRTUDH, UDHRTOPERDISC62915, UWDHMRT, UDHMRTDISC62915,</p> <p>Polygon: UWDHPOLY, UDHPOLY</p> <p>Ultimate Glider: All Unit Types</p> | <p>96" (2438) 30808396 Bare 38278396 Primed</p> <p>120" (3048) 30808398 Bare 38278398 Primed</p> |
|  | <p>12" Jamb Extension – W6380</p> <p>All Products</p> | <p>72" (1829) 37017720 Bare</p> <p>96" (2438) 37017965 Bare</p> |
|  | <p>Interior Jamb Extension – 6 9/16" – W8647</p> <p>Magnum Tilt Turn: UWTT, UTT, UWTTTOP, UTTTOP, UTTCAI, UWTTCAI</p> | <p>73" (1854) 32833272 Bare</p> <p>144" (3658) 32833299 Bare</p> |

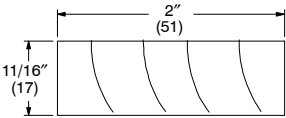
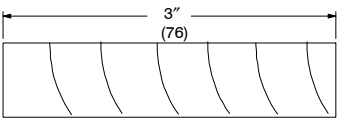
| ILLUSTRATION NOT TO SCALE | DESCRIPTION | PROFILE NUMBER |
|---|--|--|
|  | <p>Jamb Extension- 2" – W6279 Door Products NOTE: Not available in OMS. Shipping restricted to "Our Trucks" due to length of part.</p> | <p>204" (5182) 78082799 Bare</p> |
|  | <p>Jamb Extension- 3" – W6378 Door Products NOTE: Shipping restricted to "Our Trucks" due to length of part.</p> | <p>204" (5182) 78083799 Bare</p> |

| Finish | Wood Species | | | Wood Species | | |
|-----------------------|--------------------|-----------------|-----------------|--------------------|-----------------|-----------------|
| | Pine PN 96 1/8" | Pine PN 120" | Pine PN 144" | Pine PN 96 1/8" | Pine PN 120" | Pine PN 144" |
| Bare | 37015800 | 37010990 | 37015998 | 37016800 | 37011990 | 37016998 |
| White | 38615681 | 38610991 | 38600143 | 38016810 | 38011991 | 38016999 |
| Designer Black | 38615681DBK | 38610991DBK | 38600143DBK | 38016810DBK | 38011991DBK | 38016999DBK |
| Clear | CL37015800 | CL37010990 | CL37015998 | CL37016800 | CL37011990 | CL37016998 |
| Prime | 38615800 | 38610990 | 38600144 | 38016800 | 38011990 | 38016998 |
| Honey | SB37015800 | SB37010990 | SB37015998 | SB37016800 | SB37011990 | SB37016998 |
| Wheat | SA37015800 | SA37010990 | SA37015998 | SA37016800 | SA37011990 | SA37016998 |
| Cabernet | SE37015800 | SE37010990 | SE37015998 | SE37016800 | SE37011990 | SE37016998 |
| Leather | SD37015800 | SD37010990 | SD37015998 | SD37016800 | SD37011990 | SD37016998 |
| Hazelnut | SC37015800 | SC37010990 | SC37015998 | SC37016800 | SC37011990 | SC37016998 |
| Espresso | SF37015800 | SF37010990 | SF37015998 | SF37016800 | SF37011990 | SF37016998 |

W6279, 2" Jamb Extension

| Finish | Wood Species Part Numbers | | | |
|-----------------|---------------------------|-------------------|---------------------|---------------------------|
| | White Oak PN 144" | Cherry PN 144" | Mahogany PN 144" | VG Douglas Fir PN 144" |
| Bare | WK37015998 | CH37015998 | MA37015998 | DF37015998 |
| Clear | CWK37015998 | CCH37015998 | CMA37015998 | CDF37015998 |
| Honey | SBWK37015998 | SBCH37015998 | SBMA37015998 | SBDF37015998 |
| Wheat | SAWK37015998 | SACH37015998 | SAMA37015998 | SADF37015998 |
| Cabernet | SEWK37015998 | SECH37015998 | SEMA37015998 | SEDF37015998 |
| Leather | SDWK37015998 | SDCH37015998 | SDMA37015998 | SDDF37015998 |
| Hazelnut | SCWK37015998 | SCCH37015998 | SCMA37015998 | SCDF37015998 |
| Espresso | SFWK37015998 | SFCH37015998 | SFMA37015998 | SFDF37015998 |

W6378, 3" Jamb Extension

| Finish | Wood Species Part Numbers | | | |
|-----------------|---------------------------|-------------------|---------------------|---------------------------|
| | White Oak PN 144" | Cherry PN 144" | Mahogany PN 144" | VG Douglas Fir PN 144" |
| Bare | WK37016998 | CH37016998 | MA37016998 | DF37016998 |
| Clear | CWK37016998 | CCH37016998 | CMA37016998 | CDF37016998 |
| Honey | SBWK37016998 | SBCH37016998 | SBMA37016998 | SBDF37016998 |
| Wheat | SAWK37016998 | SACH37016998 | SAMA37016998 | SADF37016998 |
| Cabernet | SEWK37016998 | SECH37016998 | SEMA37016998 | SEDF37016998 |
| Leather | SDWK37016998 | SDCH37016998 | SDMA37016998 | SDDF37016998 |
| Hazelnut | SCWK37016998 | SCCH37016998 | SCMA37016998 | SCDF37016998 |
| Espresso | SFWK37016998 | SFCH37016998 | SFMA37016998 | SFDF37016998 |

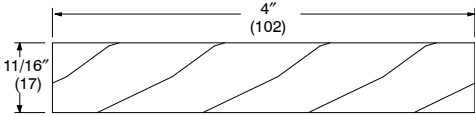
|  | | W6329 4" Jamb Extension | |
|---|--------------------|--|-----------------|
| Finish | Wood Species | | |
| | Pine PN 96 1/8" | Pine PN 120" | Pine PN 144" |
| Bare | 37020096 | 37020199 | 37020099 |
| White | 38020097 | 38020198 | 38020098 |
| Designer Black | 38020097DBK | 38020198DBK | 38020098DBK |
| Clear | CL37020096 | CL37020199 | CL37020099 |
| Prime | 38020096 | 38020199 | 38020099 |
| Honey | SB37020096 | SB37020199 | SB37020099 |
| Wheat | SA37020096 | SA37020199 | SA37020099 |
| Cabernet | SE37020096 | SE37020199 | SE37020099 |
| Leather | SD37020096 | SD37020199 | SD37020099 |
| Hazelnut | SC37020096 | SC37020199 | SC37020099 |
| Espresso | SF37020096 | SF37020199 | SF37020099 |

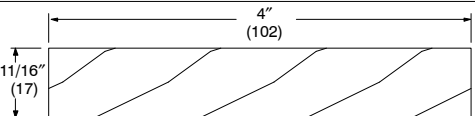
|  | | W6329 4" Jamb Extension | | |
|---|---------------------------|--|---------------------|---------------------------|
| Finish | Wood Species Part Numbers | | | |
| | White Oak PN 120" | Cherry PN 120" | Mahogany PN 120" | VG Douglas Fir PN 120" |
| Bare | WK37020199 | CH37020199 | MA37020199 | DF37020199 |
| Clear | CWK37020199 | CCH37020199 | CMA37020199 | CDF37020199 |
| Honey | SBWK37020199 | SBCH37020199 | SBMA37020199 | SBDF37020199 |
| Wheat | SAWK37020199 | SACH37020199 | SAMA37020199 | SADF37020199 |
| Cabernet | SEWK37020199 | SECH37020199 | SEMA37020199 | SEDF37020199 |
| Leather | SDWK37020199 | SDCH37020199 | SDMA37020199 | SDDF37020199 |
| Hazelnut | SCWK37020199 | SCCH37020199 | SCMA37020199 | SCDF37020199 |
| Espresso | SFWK37020199 | SFCH37020199 | SFMA37020199 | SFDF37020199 |

| Finish | Wood Species Part Numbers | | | | | |
|-----------------------|---------------------------|-----------------|------------------|------------------|--------------------------|---------------------------|
| | Pine PN 96" | Pine PN 120" | Cherry PN 96" | Cherry PN120" | VG Douglas Fir PN 96" | VG Douglas Fir PN 120" |
| Bare | 31774296 | 31774220 | CH31774296 | CH31774220 | DF31774296 | DF31774220 |
| White | 38174295 | 38174221 | - | - | - | - |
| Designer Black | 38174295DBK | 38174221DBK | - | - | - | - |
| Clear | CL31774296 | CL31774220 | CCH31774296 | CCH31774220 | CDF31774296 | CDF31774220 |
| Prime | 38174296 | 38174220 | - | - | - | - |
| Honey | SB31774296 | SB31774220 | SBCH31774296 | SBCH31774220 | SBDF31774296 | SBDF31774220 |
| Wheat | SA31774296 | SA31774220 | SACH31774296 | SACH31774220 | SADF31774296 | SADF31774220 |
| Cabernet | SE31774296 | SE31774220 | SECH31774296 | SECH31774220 | SEDF31774296 | SEDF31774220 |
| Leather | SD31774296 | SD31774220 | SDCH31774296 | SDCH31774220 | SDDF31774296 | SDDF31774220 |
| Hazelnut | SC31774296 | SC31774220 | SCCH31774296 | SCCH31774220 | SCDF31774296 | SCDF31774220 |
| Espresso | SF31774296 | SF31774220 | SFCH31774296 | SFCH31774220 | SFDF31774296 | SFDF31774220 |

| Finish | Wood Species Part Numbers | | | |
|-----------------------|---------------------------|---------------------|---------------------|----------------------|
| | Mahogany PN 96" | Mahogany PN 120" | White Oak PN 96" | White Oak PN 120" |
| Bare | MA31774296 | MA31774220 | WK31774296 | WK31774220 |
| White | - | - | - | - |
| Designer Black | - | - | - | - |
| Clear | CMA31774296 | CMA31774220 | CWK31774296 | CWK31774220 |
| Prime | - | - | - | - |
| Honey | SBMA31774296 | SBMA31774220 | SBWK31774296 | SBWK31774220 |
| Wheat | SAMA31774296 | SAMA31774220 | SAWK31774296 | SAWK31774220 |
| Cabernet | SEMA31774296 | SEMA31774220 | SEWK31774296 | SEWK31774220 |
| Leather | SDMA31774296 | SDMA31774220 | SDWK31774296 | SDWK31774220 |
| Hazelnut | SCMA31774296 | SCMA31774220 | SCWK31774296 | SCWK31774220 |
| Espresso | SFMA31774296 | SFMA31774220 | SFWK31774296 | SFWK31774220 |

| Finish | | Wood Species Part Numbers | | | | | |
|-----------------------|--|---------------------------|-----------------|------------------|-------------------|--------------------------|---------------------------|
| | | Pine PN 96" | Pine PN 120" | Cherry PN 96" | Cherry PN 120" | VG Douglas Fir PN 96" | VG Douglas Fir PN 120" |
| Bare | | 31774396 | 31774320 | CH31774396 | CH31774320 | DF31774396 | DF31774320 |
| White | | 38174395 | 38174321 | - | - | - | - |
| Designer Black | | 38174395DBK | 38174321DBK | - | - | - | - |
| Clear | | CL31774396 | CL31774320 | CCH31774396 | CCH31774320 | CDF31774396 | CDF31774320 |
| Prime | | 38174396 | 38174320 | - | - | - | - |
| Honey | | SB31774396 | SB31774320 | SBCH31774396 | SBCH31774320 | SBDF31774396 | SBDF31774320 |
| Wheat | | SA31774396 | SA31774320 | SACH31774396 | SACH31774320 | SADF31774396 | SADF31774320 |
| Cabernet | | SE31774396 | SE31774320 | SECH31774396 | SECH31774320 | SEDF31774396 | SEDF31774320 |
| Leather | | SD31774396 | SD31774320 | SDCH31774396 | SDCH31774320 | SDDF31774396 | SDDF31774320 |
| Hazelnut | | SC31774396 | SC31774320 | SCCH31774396 | SCCH31774320 | SCDF31774396 | SCDF31774320 |
| Espresso | | SF31774396 | SF31774320 | SFCH31774396 | SFCH31774320 | SFDF31774396 | SFDF31774320 |

| Finish | | Wood Species Part Numbers | | | |
|-----------------------|--|---------------------------|---------------------|---------------------|----------------------|
| | | Mahogany PN 96" | Mahogany PN 120" | White Oak PN 96" | White Oak PN 120" |
| Bare | | MA31774396 | MA31774320 | WK31774396 | WK31774320 |
| White | | - | - | - | - |
| Designer Black | | - | - | - | - |
| Clear | | CMA31774396 | CMA31774320 | CWK31774396 | CWK31774320 |
| Prime | | - | - | - | - |
| Honey | | SBMA31774396 | SBMA31774320 | SBWK31774396 | SBWK31774320 |
| Wheat | | SAMA31774396 | SAMA31774320 | SAWK31774396 | SAWK31774320 |
| Cabernet | | SEMA31774396 | SEMA31774320 | SEWK31774396 | SEWK31774320 |
| Leather | | SDMA31774396 | SDMA31774320 | SDWK31774396 | SDWK31774320 |
| Hazelnut | | SCMA31774396 | SCMA31774320 | SCWK31774396 | SCWK31774320 |
| Espresso | | SFMA31774396 | SFMA31774320 | SFWK31774396 | SFWK31774320 |

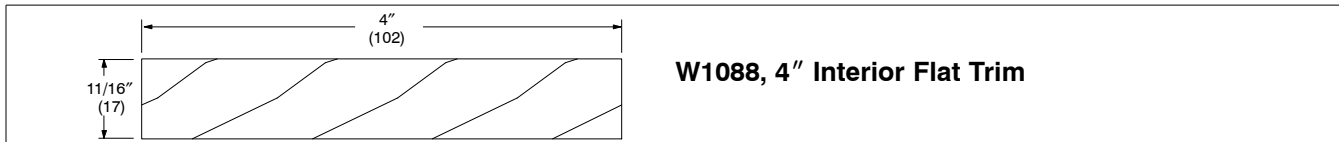

W1088, 4" Interior Flat Trim

| Finish | Wood Species Part Numbers | | | | | |
|-----------------------|---------------------------|--------------|---------------|----------------|-----------------------|------------------------|
| | Pine PN 96" | Pine PN 120" | Cherry PN 96" | Cherry PN 120" | VG Douglas Fir PN 96" | VG Douglas Fir PN 120" |
| Bare | 31774196 | 31774142 | CH31774196 | CH31774142 | DF31774196 | DF31774142 |
| White | 38174195 | 38174143 | - | - | - | - |
| Designer Black | 38174195DBK | 38174143DBK | - | - | - | - |
| Clear | CL31774196 | CL31774142 | CCH31774196 | CCH31774142 | CDF31774196 | CDF31774142 |
| Prime | 38174196 | 38174142 | - | - | - | - |
| Honey | SB31774196 | SB31774142 | SBCH31774196 | SBCH31774142 | SBDF31774196 | SBDF31774142 |
| Wheat | SA31774196 | SA31774142 | SACH31774196 | SACH31774142 | SADF31774196 | SADF31774142 |
| Cabernet | SE31774196 | SE31774142 | SECH31774196 | SECH31774142 | SEDF31774196 | SEDF31774142 |
| Leather | SD31774196 | SD31774142 | SDCH31774196 | SDCH31774142 | SDDF31774196 | SDDF31774142 |
| Hazelnut | SC31774196 | SC31774142 | SCCH31774196 | SCCH31774142 | SCDF31774196 | SCDF31774142 |
| Espresso | SF31774196 | SF31774142 | SFCH31774196 | SFCH31774142 | SFDF31774196 | SFDF31774142 |

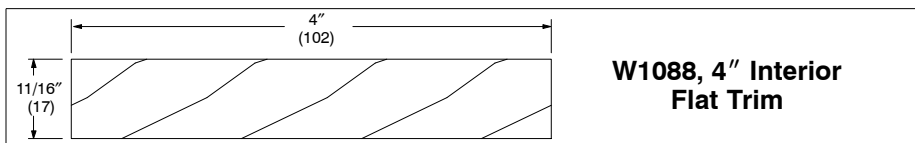

W1088, 4" Interior Flat Trim

| Finish | Wood Species Part Numbers | | | |
|-----------------------|---------------------------|------------------|------------------|-------------------|
| | Mahogany PN 96" | Mahogany PN 120" | White Oak PN 96" | White Oak PN 120" |
| Bare | MA31774196 | MA31774142 | WK31774196 | WK31774142 |
| White | - | - | - | - |
| Designer Black | - | - | - | - |
| Clear | CMA31774196 | CMA31774142 | CWK31774196 | CWK31774142 |
| Prime | - | - | - | - |
| Honey | SBMA31774196 | SBMA31774142 | SBWK31774196 | SBWK31774142 |
| Wheat | SAMA31774196 | SAMA31774142 | SAWK31774196 | SAWK31774142 |
| Cabernet | SEMA31774196 | SEMA31774142 | SEWK31774196 | SEWK31774142 |
| Leather | SDMA31774196 | SDMA31774142 | SDWK31774196 | SDWK31774142 |
| Hazelnut | SCMA31774196 | SCMA31774142 | SCWK31774196 | SCWK31774142 |
| Espresso | SFMA31774196 | SFMA31774142 | SFWK31774196 | SFWK31774142 |

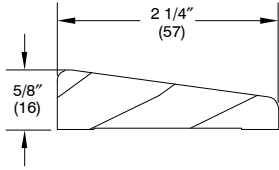

W1144, MM44 Interior Casing

| Finish | Wood Species | | | | | |
|-----------------------|--------------|--------------|---------------|-----------------------|-----------------|------------------|
| | Pine PN 84" | Pine PN 120" | Cherry PN 84" | VG Douglas Fir PN 84" | Mahogany PN 84" | White Oak PN 84" |
| Bare | 31772048 | 31772099 | CH31772048 | DF31772048 | MA31772048 | WK31772048 |
| White | 38772049 | 38772098 | - | - | - | - |
| Designer Black | 38772049DBK | 38772098DBK | - | - | - | - |
| Clear | CL31772048 | CL31772099 | CCH31772048 | CDF31772048 | CMA31772048 | CWK31772048 |
| Prime | 38772048 | 38772099 | - | - | - | - |
| Honey | SB31772048 | SB31772099 | SBCH31772048 | SBDF31772048 | SBMA31772048 | SBWK31772048 |
| Wheat | SA31772048 | SA31772099 | SACH31772048 | SADF31772048 | SAMA31772048 | SAWK31772048 |
| Cabernet | SE31772048 | SE31772099 | SECH31772048 | SEDF31772048 | SEMA31772048 | SEWK31772048 |
| Leather | SD31772048 | SD31772099 | SDCH31772048 | SDDF31772048 | SDMA31772048 | SDWK31772048 |
| Hazelnut | SC31772048 | SC31772099 | SCCH31772048 | SCDF31772048 | SCMA31772048 | SCWK31772048 |
| Espresso | SF31772048 | SF31772099 | SFCH31772048 | SFDF31772048 | SFMA31772048 | SFWK31772048 |

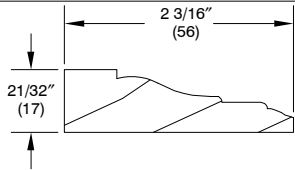

W1366, WP366 Interior Casing

| Finish | Wood Species | | | | | |
|-----------------------|--------------|--------------|---------------|-----------------------|-----------------|------------------|
| | Pine PN 84" | Pine PN 120" | Cherry PN 84" | VG Douglas Fir PN 84" | Mahogany PN 84" | White Oak PN 84" |
| Bare | 31760784 | 31760999 | CH31760784 | DF31760784 | MA31760784 | WK31760784 |
| White | 38760785 | 38760997 | - | - | - | - |
| Designer Black | 38760785DBK | 38760997DBK | - | - | - | - |
| Clear | CL31760784 | CL31760999 | CCH31760784 | CDF31760784 | CMA31760784 | CWK31760784 |
| Prime | 38760784 | 38760999 | - | - | - | - |
| Honey | SB31760784 | SB31760999 | SBCH31760784 | SBDF31760784 | SBMA31760784 | SBWK31760784 |
| Wheat | SA31760784 | SA31760999 | SACH31760784 | SADF31760784 | SAMA31760784 | SAWK31760784 |
| Cabernet | SE31760784 | SE31760999 | SECH31760784 | SEDF31760784 | SEMA31760784 | SEWK31760784 |
| Leather | SD31760784 | SD31760999 | SDCH31760784 | SDDF31760784 | SDMA31760784 | SDWK31760784 |
| Hazelnut | SC31760784 | SC31760999 | SCCH31760784 | SCDF31760784 | SCMA31760784 | SCWK31760784 |
| Espresso | SF31760784 | SF31760999 | SFCH31760784 | SFDF31760784 | SFMA31760784 | SFWK31760784 |

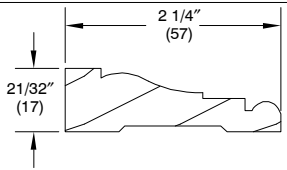

W1376, MM376 Interior Casing

| Finish | Wood Species | | | | | |
|-----------------------|--------------|--------------|---------------|-----------------------|-----------------|------------------|
| | Pine PN 84" | Pine PN 120" | Cherry PN 84" | VG Douglas Fir PN 84" | Mahogany PN 84" | White Oak PN 84" |
| Bare | 31771075 | 31771069 | CH31771075 | DF31771075 | MA31771075 | WK31771075 |
| White | 38771074 | 38771072 | - | - | - | - |
| Designer Black | 38771074DBK | 38771072DBK | - | - | - | - |
| Clear | CL31771075 | CL31771069 | CCH31771075 | CDF31771075 | CMA31771075 | CWK31771075 |
| Prime | 38771075 | 38771069 | - | - | - | - |
| Honey | SB31771075 | SB31771069 | SBCH31771075 | SBDF31771075 | SBMA31771075 | SBWK31771075 |
| Wheat | SA31771075 | SA31771069 | SACH31771075 | SADF31771075 | SAMA31771075 | SAWK31771075 |
| Cabernet | SE31771075 | SE31771069 | SECH31771075 | SEDF31771075 | SEMA31771075 | SEWK31771075 |
| Leather | SD31771075 | SD31771069 | SDCH31771075 | SDDF31771075 | SDMA31771075 | SDWK31771075 |
| Hazelnut | SC31771075 | SC31771069 | SCCH31771075 | SCDF31771075 | SCMA31771075 | SCWK31771075 |
| Espresso | SF31771075 | SF31771069 | SFCH31771075 | SFDF31771075 | SFMA31771075 | SFWK31771075 |

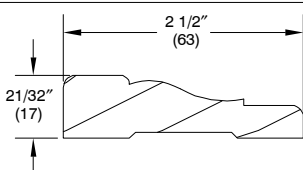

W1351, WM351 Interior Casing

| Finish | Wood Species | | | | | |
|-----------------------|--------------|--------------|---------------|-----------------------|-----------------|------------------|
| | Pine PN 84" | Pine PN 120" | Cherry PN 84" | VG Douglas Fir PN 84" | Mahogany PN 84" | White Oak PN 84" |
| Bare | 31771071 | 31771068 | CH31771071 | DF31771071 | MA31771071 | WK31771071 |
| White | 38771077 | 38771067 | - | - | - | - |
| Designer Black | 38771077DBK | 38771067DBK | - | - | - | - |
| Clear | CL31771071 | CL31771068 | CCH31771071 | CDF31771071 | CMA31771071 | CWK31771071 |
| Prime | 38771071 | 38771068 | - | - | - | - |
| Honey | SB31771071 | SB31771068 | SBCH31771071 | SBDF31771071 | SBMA31771071 | SBWK31771071 |
| Wheat | SA31771071 | SA31771068 | SACH31771071 | SADF31771071 | SAMA31771071 | SAWK31771071 |
| Cabernet | SE31771071 | SE31771068 | SECH31771071 | SEDF31771071 | SEMA31771071 | SEWK31771071 |
| Leather | SD31771071 | SD31771068 | SDCH31771071 | SDDF31771071 | SDMA31771071 | SDWK31771071 |
| Hazelnut | SC31771071 | SC31771068 | SCCH31771071 | SCDF31771071 | SCMA31771071 | SCWK31771071 |
| Espresso | SF31771071 | SF31771068 | SFCH31771071 | SFDF31771071 | SFMA31771071 | SFWK31771071 |

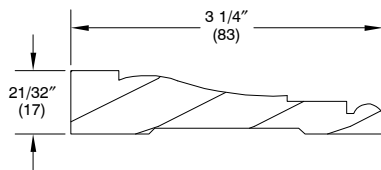

W1445, WM445 Interior Casing

| Finish | Wood Species | | | | | |
|-----------------------|----------------|-----------------|------------------|--------------------------|--------------------|---------------------|
| | Pine PN 84" | Pine PN 120" | Cherry PN 84" | VG Douglas Fir PN 84" | Mahogany PN 84" | White Oak PN 84" |
| Bare | 31771060 | 31771070 | CH31771060 | DF31771060 | MA31771060 | WK31771060 |
| White | 38771061 | 38771097 | - | - | - | - |
| Designer Black | 38771061DBK | 38771097DBK | - | - | - | - |
| Clear | CL31771060 | CL31771070 | CCH31771060 | CDF31771060 | CMA31771060 | CWK31771060 |
| Prime | 38771060 | 38771070 | - | - | - | - |
| Honey | SB31771060 | SB31771070 | SBCH31771060 | SBDF31771060 | SBMA31771060 | SBWK31771060 |
| Wheat | SA31771060 | SA31771070 | SACH31771060 | SADF31771060 | SAMA31771060 | SAWK31771060 |
| Cabernet | SE31771060 | SE31771070 | SECH31771060 | SEDF31771060 | SEMA31771060 | SEWK31771060 |
| Leather | SD31771060 | SD31771070 | SDCH31771060 | SDDF31771060 | SDMA31771060 | SDWK31771060 |
| Hazelnut | SC31771060 | SC31771070 | SCCH31771060 | SCDF31771060 | SCMA31771060 | SCWK31771060 |
| Espresso | SF31771060 | SF31771070 | SFCH31771060 | SFDF31771060 | SFMA31771060 | SFWK31771060 |

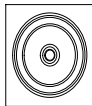

3" Plinth Block

| Finish | Wood Species | | | | |
|----------------|--------------|--------------|----------------|--------------|--------------|
| | Pine | Cherry | VG Douglas Fir | Mahogany | White Oak |
| Bare | 11850093 | 10499103 | 10499105 | 10499104 | 10499102 |
| White | 10499119 | - | - | - | - |
| Designer Black | 10499142 | - | - | - | - |
| Clear | CL11850093 | CCH10499103 | CDF10499105 | CMA10499104 | CWK10499102 |
| Prime | 10499118 | - | - | - | - |
| Honey | SB11850093 | SBCH10499103 | SBDF10499105 | SBMA10499104 | SBWK10499102 |
| Wheat | SA11850093 | SACH10499103 | SADF10499105 | SAMA10499104 | SAWK10499102 |
| Cabernet | SE11850093 | SECH10499103 | SEDF10499105 | SEMA10499104 | SEWK10499102 |
| Leather | SD11850093 | SDCH10499103 | SDDF10499105 | SDMA10499104 | SDWK10499102 |
| Hazelnut | SC11850093 | SCCH10499103 | SCDF10499105 | SCMA10499104 | SCWK10499102 |
| Espresso | SF11850093 | SFCH10499103 | SFDF10499105 | SFMA10499104 | SFWK10499102 |

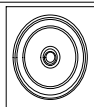

4" Plinth Block

| Finish | Wood Species | | | | |
|----------------|--------------|--------------|----------------|--------------|--------------|
| | Pine | Cherry | VG Douglas Fir | Mahogany | White Oak |
| Bare | 11850092 | 10499112 | 10499114 | 10499113 | 10499111 |
| White | 10499121 | - | - | - | - |
| Designer Black | 10499143 | - | - | - | - |
| Clear | CL11850092 | CCH10499112 | CDF10499114 | CMA10499113 | CWK10499111 |
| Prime | 10499120 | - | - | - | - |
| Honey | SB11850092 | SBCH10499112 | SBDF10499114 | SBMA10499113 | SBWK10499111 |
| Wheat | SA11850092 | SACH10499112 | SADF10499114 | SAMA10499113 | SAWK10499111 |
| Cabernet | SE11850092 | SECH10499112 | SEDF10499114 | SEMA10499113 | SEWK10499111 |
| Leather | SD11850092 | SDCH10499112 | SDDF10499114 | SDMA10499113 | SDWK10499111 |
| Hazelnut | SC11850092 | SCCH10499112 | SCDF10499114 | SCMA10499113 | SCWK10499111 |
| Espresso | SF11850092 | SFCH10499112 | SFDF10499114 | SFMA10499113 | SFWK10499111 |



3/8" Flat Head Plug

| Finish | Wood Species | | | | |
|----------------|--------------|----------|----------------|----------|-----------|
| | Pine | Cherry | VG Douglas Fir | Mahogany | White Oak |
| Bare | 02074845 | 02074888 | 02074889 | 02074887 | 02074844 |
| White | 02072829 | - | - | - | - |
| Designer Black | 02072842 | - | - | - | - |
| Clear | 11100802 | 11100804 | 11100805 | 11100803 | 11100801 |
| Honey | 11100817 | 11100814 | 11100815 | 11100813 | 11100818 |
| Wheat | 11100811 | 11100808 | 11100809 | 11100807 | 11100812 |
| Cabernet | 11100835 | 11100832 | 11100833 | 11100831 | 11100836 |
| Leather | 11100829 | 11100826 | 11100827 | 11100825 | 11100830 |
| Hazelnut | 11100823 | 11100820 | 11100821 | 11100819 | 11100824 |
| Espresso | 11100841 | 11100838 | 11100839 | 11100837 | 11100842 |

When ordering replacement wood parts specify:

1. profile number;
2. size – (call number or length);
3. wood species;
4. finish.

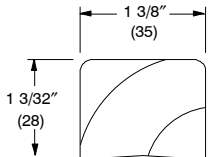
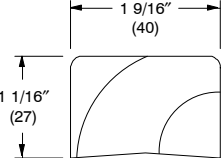
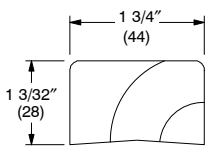
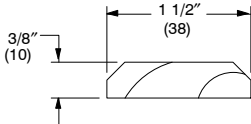
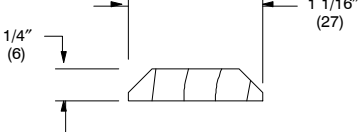
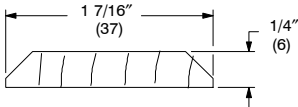
| ILLUSTRATION NOT TO SCALE | DESCRIPTION | PROFILE NUMBER |
|---|---|----------------|
|  | <p>Mullion Casing UWDH, UWDHRT, UWDHPOLY, UWDHP, UWDHTR</p> <p>Longest Length Available 120" (3048)</p> | <p>W1032</p> |
|  | <p>Mullion Casing Gliders</p> <p>Longest Length Available 53 5/8" (1362)</p> | <p>W1034</p> |
|  | <p>Mullion Casing UWDH, UWDHRT, UWDHPOLY</p> <p>Longest Length Available 168" (4267)</p> | <p>W1094</p> |
|  | <p>Mullion Trim, Exterior UWTT, UWTTTOP</p> <p>Longest Length Available 120" (3048)</p> | <p>W1210</p> |
|  | <p>Mullion Trim UWCA, UWAWN, UWCAOPERRT, UWCAOPERPOLY</p> <p>Longest Length Available 150" (3810)</p> | <p>W1241</p> |
|  | <p>Mullion Trim 3/8" mullion reinforcement</p> <p>Longest Length Available 150" (3810)</p> | <p>W1242</p> |

NOTE: Stucco casing is **not** available for head jamb application.

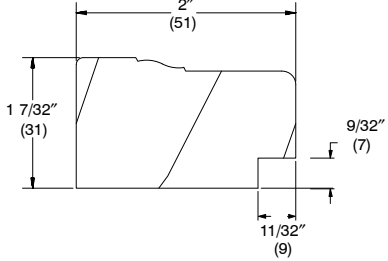
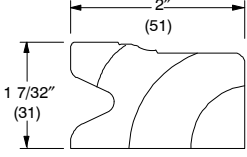
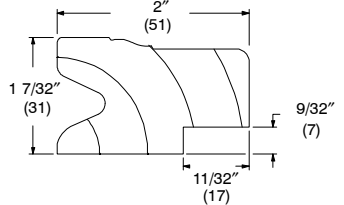
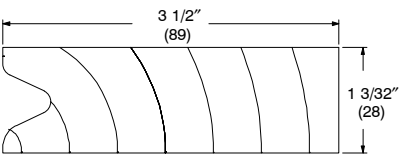
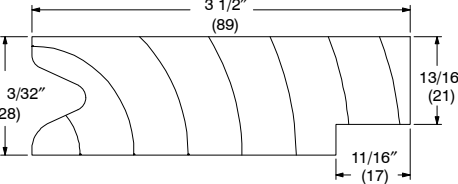
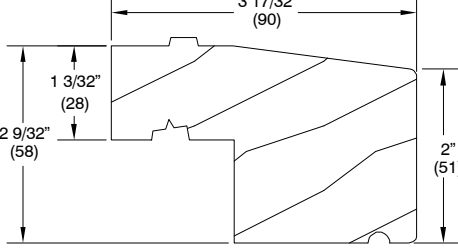
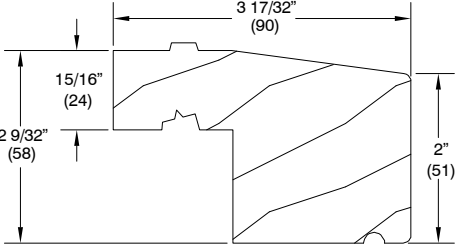
| ILLUSTRATION NOT TO SCALE | DESCRIPTION | PROFILE NUMBER |
|---|--|----------------|
|  | <p>Brick Mould Casing UWIFD and Transom, UWSFD, UWOFD, UWSPD, UWIFDAT</p> <p>Longest Length Available 148" (3759)</p> | <p>W6533</p> |
|  | <p>Stucco Casing</p> <p>Longest Length Available 204" (5182)</p> | <p>W1039</p> |
|  | <p>Stucco Casing - UWSFD, UTPDDISC2003 Side - (with backrabbet)</p> <p>Longest Length Available 96" (2438)</p> | <p>W1049</p> |
|  | <p>Stucco Casing, Flat 3 1/2" width</p> <p>Longest Length Available 120" (3048)</p> | <p>W1035</p> |
|  | <p>Stucco Casing - UWSFD, UTPDDISC2003 Side - 3 1/2" width (with backrabbet)</p> <p>Longest Length Available 120" (3048)</p> | <p>W1030</p> |
|  | <p>W8063, Extended Thick Subsill - UWDH</p> <p>Non Finger-Jointed- 73" (1854) 30268072 Finger-Jointed - 73" (1854) 30268172 Non Finger-Jointed- 120" (3048) 30268098 Finger-Jointed - 120" (3048) 30268198</p> | |
|  | <p>W10341, 2" Extended Thick Subsill - UWCA</p> <p>Non Finger-Jointed- 120" (3048) 30370298 Finger-Jointed - 120" (3048) 30370398</p> | |

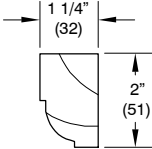
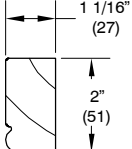
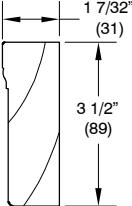
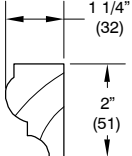
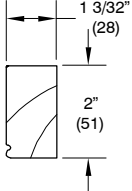
| ILLUSTRATION NOT TO SCALE | DESCRIPTION | PART NUMBER |
|---|--|--|
|  | Special Casing 3 – W8487 Primed Bare Non-FJ | 120" (3048) 38026003 30146003 30146103 |
|  | Special Casing 7 – W8491 Primed Bare Non-FJ | 120" (3048) 38026007 30146007 30146107 |
|  | Special Casing 18 – W8502 Primed Bare Non-FJ | 120" (3048) 38026018 30146018 30146118 |
|  | Special Casing 21 – W8505 Primed Bare Non-FJ | 120" (3048) 38026021 30146121 30146021 |
|  | Special Casing 26 – W8510 Primed Bare Non-FJ | 120" (3048) 38026026 30146026 30146126 |

When ordering replacement wood parts specify:

1. product type;
2. call number or rough opening;
3. profile number;
4. length;
5. finish.

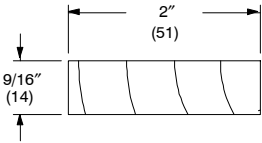
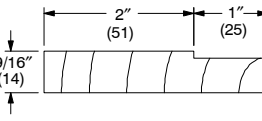
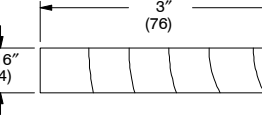
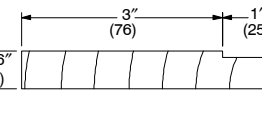
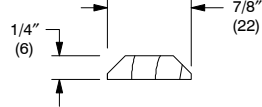
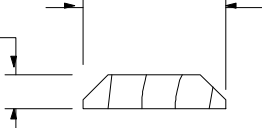
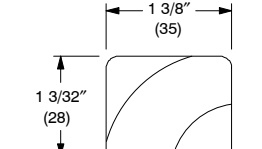
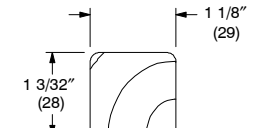
| ILLUSTRATION NOT TO SCALE | DESCRIPTION | PROFILE NUMBER |
|---|---|----------------|
|  | 2" Jamb Extension Terrace Door – head jamb or stationary side jamb Inswing French Door (pre- 5/98) – head jamb or stationary side jamb | W6270 |
|  | 2" Jamb Extension Terrace Door – operating side jambs Inswing French Door (pre- 5/98) – operating side jambs | W7228 |
|  | 3" Jamb Extension Terrace Door – head jamb or stationary side jamb Inswing French Door (pre- 5/98) – head jamb or stationary side jamb | W6310 |
|  | 3" Jamb Extension Terrace Door – operating side jambs Inswing French Door (pre- 5/98) – operating side jambs | W7229 |
|  | Mullion Trim Terrace Door Inswing French Door | W1195 |
|  | Mullion Trim Terrace Door, French Door | W1241 |
|  | Mullion Casing Double Hung | W1032 |
|  | Mullion Casing French Door | W1096 |

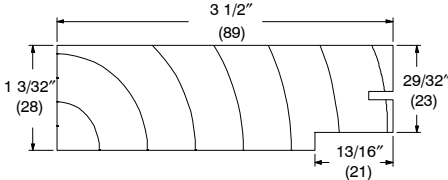
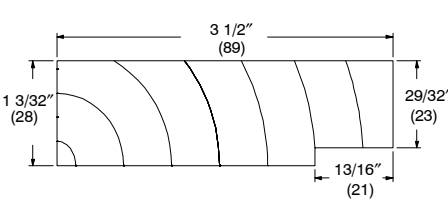
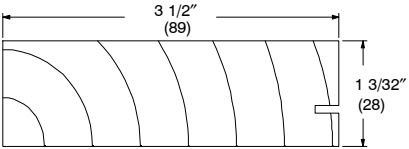
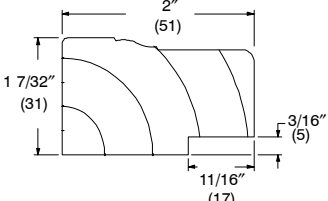
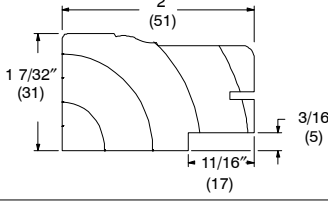
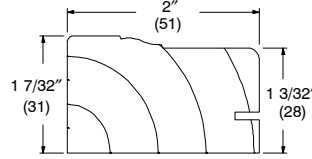
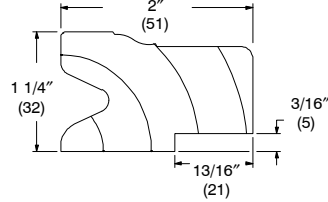
| ILLUSTRATION NOT TO SCALE | DESCRIPTION | PROFILE NUMBER |
|---|--|----------------|
|  | <p>5/4 Flat Casing – Safe-T-Plus Patio Door Top – 3 1/2" width (with screen track kerf and backrabbet)</p> | <p>W1070</p> |
|  | <p>5/4 Flat Casing – Safe-T-Plus Patio Door Side – 3 1/2" width (with backrabbet)</p> | <p>W1072</p> |
|  | <p>5/4 Flat Casing – Terrace Door Top – 3 1/2" width (with screen track kerf)</p> | <p>W1060</p> |
|  | <p>Brick Mould Casing – Safe-T-Plus Patio Door Side – (with backrabbet)</p> | <p>W1055</p> |
|  | <p>Brick Mould Casing – Safe-T-Plus Patio Door Top – (with screen track kerf and backrabbet)</p> | <p>W1057</p> |
|  | <p>Brick Mould Casing – Terrace Door Top – (with screen track kerf)</p> | <p>W1058</p> |
|  | <p>Stucco Casing – Safe-T-Plus Patio Door Side – (with backrabbet)</p> | <p>W1046</p> |

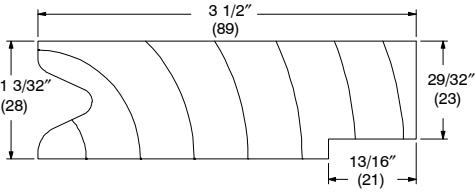

| ILLUSTRATION NOT TO SCALE | DESCRIPTION | PROFILE NUMBER |
|--|---|----------------|
|  <p>Technical drawing of a wood profile with the following dimensions:</p> <ul style="list-style-type: none"> Top width: 3 1/2" (89) Left height: 1 3/32" (28) Right height: 29/32" (23) Bottom width of the backrabbet: 13/16" (21) | <p>Stucco Casing, Flat – Safe-T-Plus Patio Door Side – 3 1/2" width (with backrabbet)</p> | <p>W1033</p> |

When ordering installation accessories specify:

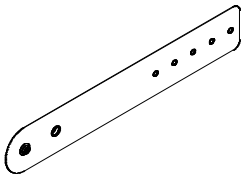
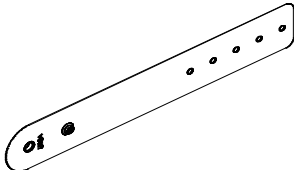
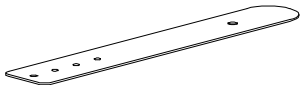
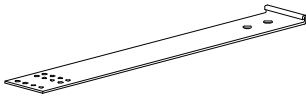
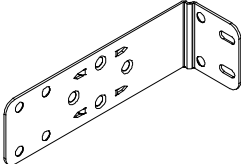
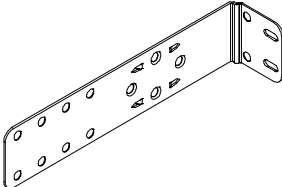
1. part number;
2. description;
3. length (if applicable).

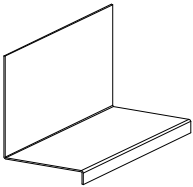
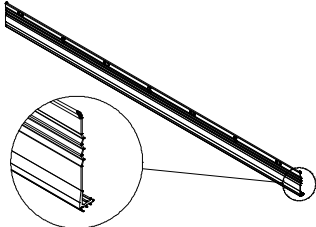
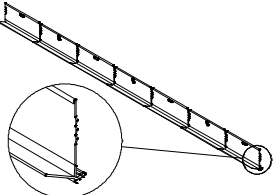
| ILLUSTRATION NOT TO SCALE | DESCRIPTION | COLOR | PART NO. |
|---|---|-------|----------------------------------|
|  | <p>Installation Bracket – 6 3/8" MISC 048 <i>Includes #7x5/8" Phillips flathead wood screws (11800758)</i> <i>For URCA, #8x1/2" screws will be included (11800502)</i></p> <p style="text-align: right;">Each pkg. 100 pkg. 250</p> | | 11850048 11850052 11850053 |
|  | <p>Installation Bracket – 9 3/8" MISC 076 <i>Includes #7x5/8" Phillips flathead wood screws (11800758)</i> <i>For URCA, #8x1/2" screws will be included (11800502)</i></p> <p style="text-align: right;">Each pkg. 100 pkg. 250</p> | | 11850047 11850050 11850051 |
|  | <p>Installation Bracket – 15 3/8" MISC 0500 <i>Includes #7X5/8" Phillips flathead wood screws (11800758)</i></p> <p style="text-align: right;">Each pkg. 100</p> | | 11850040 11850041 |
|  | <p>Structural Masonry Brackets MISC 1199</p> <p style="text-align: right;">6" Each 10"</p> | | 11860012 11860013 |
|  | <p>Structural Bracket, 4 9/16"</p> | Each | 11860036 |
|  | <p>Structural Bracket, 6 9/16"</p> | Each | 11860032 |

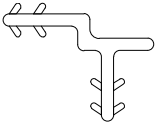
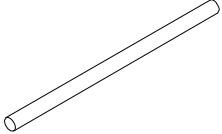
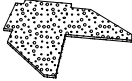
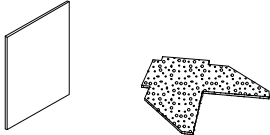
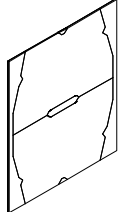
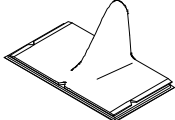
| ILLUSTRATION NOT TO SCALE | DESCRIPTION | COLOR | PART NO. |
|---|--|--|---|
|  | <p>Drip Cap (Aluminum Flashing) A100 Optional with all Ultimate and Ultimate wood units with casing</p> <p style="text-align: right;">150" (3810)</p> | <p>Stone White Bronze Brown Pebble Evergreen</p> | <p>18803599 15227999 15227799 15227899 15227650</p> |
|  | <p>Aluminum Nail Fin 96" (2438)</p> | | <p>16212699</p> |
|  | <p>Aluminum Nail Fin - Radius Units 96" (2438)</p> | | <p>16214596</p> |

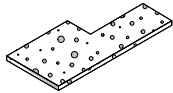
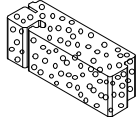
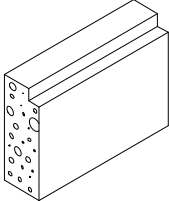
| ILLUSTRATION NOT TO SCALE | DESCRIPTION | COLOR | PART NO. |
|---|---|-------|----------------------|
|  | Connecting Barb V087 150" (3810) 58" (1473) | | 16000600 16000601 |
|  | Accessory Kerf Weather Strip - Frame MISC 1242 Specify length 5/32" diameter | Beige | 15910100 |
|  | Foam Corner Gasket - Nailing Fin Adhesive backed Package of 4 | White | 11869519 |
|  | Foam Corner Gasket Set - Round Tops Adhesive backed <i>Includes</i> 2 - 90 degree gaskets (11869519) 2 - Nailing fin connectors (10500213) | | 11869523 |
|  | Flat Gasket (Pair) Aluminum Nail Fin Splicing Gasket | | 11869826 |
|  | Preformed Corner Gasket Aluminum Nail Fin | | 10500422 |
|  | Foam Mulling Tape MISC 568 100' 96" (2438) | Black | 11406224 11869508 |
|  | Header Stop Pad MISC 1248 Package of 2 | Gray | 10500214 |
|  | Foam Plug, Clad Flat Casing MISC 0509 | White | 10500002 |
|  | Foam Sealant Block for Space Mull and Stud Pocket 96" (2438) | | 10500018 |

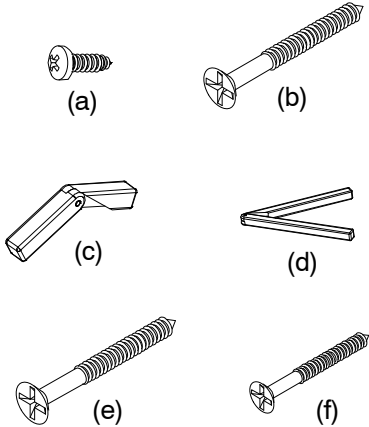
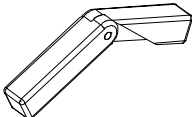
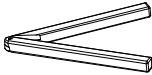
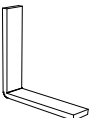
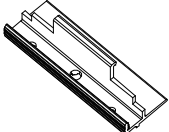
| ILLUSTRATION NOT TO SCALE | DESCRIPTION | COLOR | PART NO. |
|---|--|-------------|----------|
|  | Field Applied CBMC Package Rectangular 12-#8x5/8" Phillips Panhead Screws (a) (11800498) 5-#8 x 1 1/2" Phillips Flathead Screws (b) (11808110) 1-Instruction (11708096) | | 11850119 |
| | Field Applied CBMC Package Round Top 3-2" Pivoting Corner Key (c) (11870477) 2-6" Pivoting Corner Key (d) (11870479) 12-#8x5/8" Phillips Panhead Screws (a) (11800498) 3-#8x1 1/2" Phillips Flathead Screws (b) (11808110) 7-#7x5/8" Phillips Flathead Screws (e) (11800734) 1-Instruction (11708097) | | 11850118 |
| | Field Applied CBMC Package Polygon 3-2" Pivoting Corner Key (c) (11870477) 2-6" Pivoting Corner Key (d) (11870479) 3-#8x2" Phillips Flathead Screws (f) (11800724) 12-#8x5/8" Phillips Panhead Screws (a) (11800498) 3-#8x1 1/2" Phillips Flathead Screws (b) (11808110) 7-#7x5/8" Phillips Flathead Screws € (11800734) 1-Instruction (11708097) | | 11850123 |
|  | 2" Pivoting Corner Key | | 11870477 |
|  | 6" Pivoting Corner Key NOTE: For angles sharper than 45° | | 11870479 |
|  | Corner Key - Adjustable Brick Mould Casing Package of 50 | Mill Finish | 02010232 |
|  | Clad Flat Casing Fastening Clip A244 3" (76) | | 18614502 |

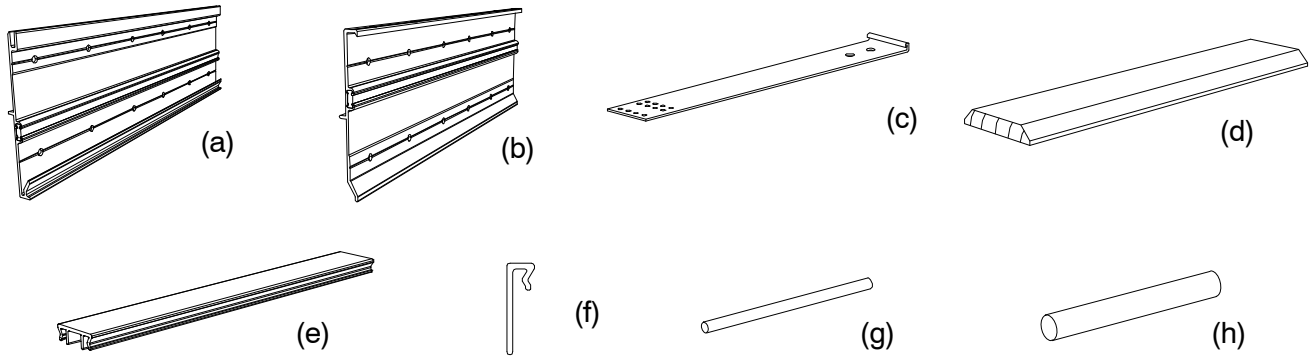
| ILLUSTRATION NOT TO SCALE | | |
|--|---|----------|
|  | | |
| DESCRIPTION | COLOR | PART NO. |
| <p>Clad 3/8" Mullion Reinforcement System Full Frame 150" lineal package</p> <p><i>Includes:</i></p> <ul style="list-style-type: none"> 1 – Mullion reinforcement–head jamb or right jamb, A3177, 18817110 (a) 1 – Mullion reinforcement–sill or left jamb, A3273, 11817115 (b) 4 – 6" structural masonry clip, 11860012 (c) 4 – 10" structural masonry clip, 11860013 (c) 1 – Interior mullion trim – W1242 (d) 1 – 3/8" mullion cover, A117 (e) (see A117 in this chapter for individual part numbers) 2 – Frame trim, A148, 3/8" (f) (see A148 in this chapter for individual part numbers) 1 – Frame kerf weather strip, M1242, 15910100(g) 1 – Foam backer rod– 3/4" diameter, 10500228 (h) 1 – Set of installation instructions <p>NOTE: All screws needed for installation are included.</p> | <ul style="list-style-type: none"> Stone White 11873145 Bronze 11873143 Pebble 11873142 Brown 11873141 Evergreen 11873144 Wineberry 11873125 Ebony 11873126 Cashmere 11873127 Coconut Cream 11873130 Cadet Gray 11873131 Cascade Blue 11873132 Hampton Sage 11873133 Sierra White 11873134 Bright Silver 11873147 Copper 11873146 Clay 11873151 Gunmetal 11873149 Liberty Bronze 11873148 Suede 11873150 | |

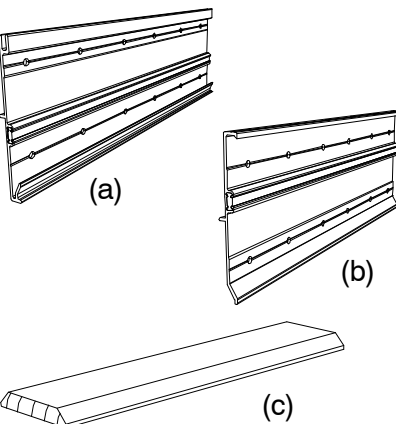
| ILLUSTRATION NOT TO SCALE | DESCRIPTION | COLOR | PART NO. |
|---|--|-------|----------|
|  | <p>Wood 3/8" Mullion Reinforcement System Full Frame 150" lineal package</p> <p><i>Includes:</i></p> <ul style="list-style-type: none"> 1 – Mullion reinforcement–head jamb or right jamb, A3177, 18817110 (a) 1 – Mullion reinforcement–sill or left jamb, A3273, 11817115 (b) 1 – Interior and exterior mullion trim – W1242 (c) 1 – Set of installation instructions <p>NOTE: All screws needed for installation are included.</p> | | 11873100 |

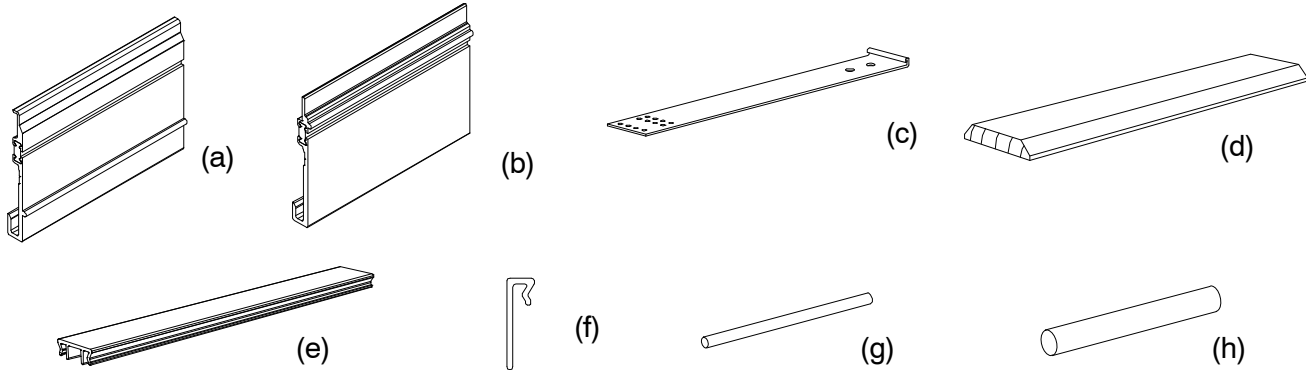
| ILLUSTRATION NOT TO SCALE | | |
|---|--|--|
|  | | |
| DESCRIPTION | COLOR | PART NO. |
| <p>Clad 3/8" Mullion Reinforcement System Narrow Frame 150" lineal package</p> <p><i>Includes:</i> 1 – Mullion reinforcement–head jamb or right jamb, A3198, 18817100 (a) 1 – Mullion reinforcement–sill or left jamb, A3274, 11817105 (b) 4 – 6" structural masonry clip, 11860012 (c) 4 – 10" structural masonry clip, 11860013 (c) 1 – Interior mullion trim, W1242 (d) 1 – 3/8" mullion cover, A117 (e) (see A117 in this chapter for individual part numbers) 2 – Frame trim, A148, 3/8" (f) (see A148 in this chapter for individual part numbers) 1 – Frame kerf weather strip, M1242, 15910100(g) 1 – Foam backer rod– 3/4" diameter, 10500228 (h) 1 – Set of installation instructions</p> <p>NOTE: All screws needed for installation are included.</p> | Stone White Bronze Pebble Brown Evergreen Wineberry Ebony Cashmere Coconut Cream Cadet Gray Cascade Blue Hampton Sage Sierra White Bright Silver Copper Clay Gunmetal Liberty Bronze Suede | 11873244 11873242 11873241 11873240 11873243 11873245 11873246 11873247 11873249 11873248 11873250 11873251 11873252 11873254 11873253 11873255 11873256 11873257 11873258 |

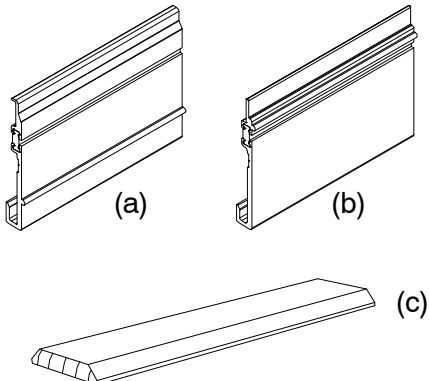
| ILLUSTRATION NOT TO SCALE | DESCRIPTION | COLOR | PART NO. |
|---|--|-------|----------|
|  | <p>Wood 3/8" Mullion Reinforcement System Narrow Frame 150" lineal package</p> <p><i>Includes:</i> 1 – Mullion reinforcement–head jamb or right jamb, A3198, 18817100 (a) 1 – Mullion reinforcement–sill or left jamb, A3274, 11817105 (b) 1 – Interior and exterior mullion trim – W1242 (c) 1 – Set of installation instructions</p> <p>NOTE: All screws needed for installation are included.</p> | | 11873259 |

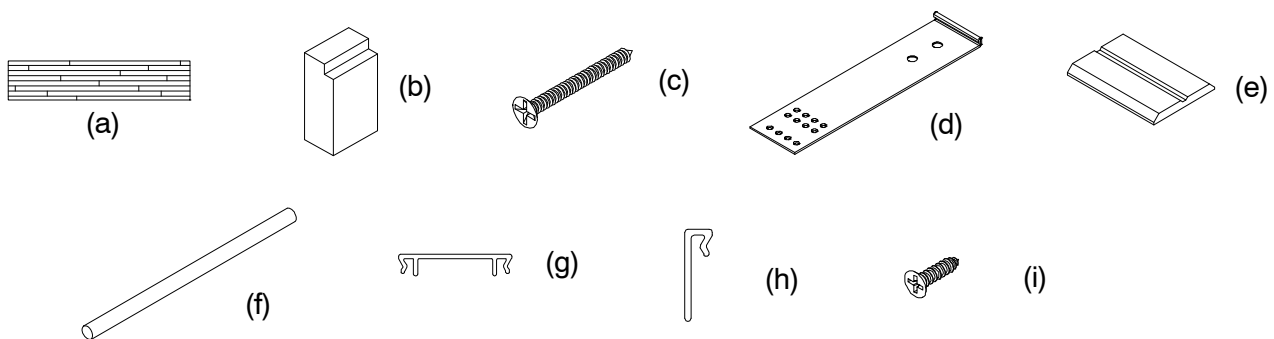
| ILLUSTRATION NOT TO SCALE | | |
|--|---|---|
|  | | |
| DESCRIPTION | COLOR | PART NO. |
| <p>Clad 130" Mull Kit – 1" x 4 9/16" LVL</p> <p><i>Includes:</i></p> <p>1 – W8677 Mull Post, 130" (3302) – 30251199 (a)</p> <p>1 – Mull Sealant Blocks – 10500018(b)</p> <p>24 – #8–15x1 1/4" Flat Head Screws–11808114(c)</p> <p>12 – 10" Masonry Clips – 11860013 (d)</p> <p>12 – 6" Masonry Clips – 11860012 (d)</p> <p>1 – Interior Mull Trim – 30803399 (e)</p> <p>1 – Frame Kerf Weather Strip, 260" (6604) length – M1242 (f)</p> <p>1 – A111 1" Space Mull Cover (g)</p> <p>BN – 18600610 BZ – 18600630</p> <p>PB – 18600620 EG – 18600640</p> <p>SW – 18800880</p> <p>2 – A148 Frame Trim (h)</p> <p>BN – 15224810 BZ – 15224830</p> <p>PB – 15224820 EG – 15224840</p> <p>SW – 18801440</p> <p>24 – #8–15x 5/8" Flat Head Screws–11800499(i)</p> <p>Mulling Instructions – 19970066</p> <p>Masonry Clip Instructions – 11708266</p> | <p>Brown</p> <p>Pebble</p> <p>Bronze</p> <p>Evergreen</p> <p>Stone White</p> <p>Wineberry</p> <p>Ebony</p> <p>Cashmere</p> <p>Cadet Gray</p> <p>Coconut Cream</p> <p>Cascade Blue</p> <p>Hampton Sage</p> <p>Sierra White</p> <p>Copper</p> <p>Bright Silver</p> <p>Clay</p> <p>Gunmetal</p> <p>Liberty Bronze</p> <p>Suede</p> | <p>11851122</p> <p>11851123</p> <p>11851124</p> <p>11851125</p> <p>11851126</p> <p>11851275</p> <p>11851277</p> <p>11851278</p> <p>11851280</p> <p>11851281</p> <p>11851282</p> <p>11851283</p> <p>11851284</p> <p>11851285</p> <p>11851286</p> <p>11851288</p> <p>11851289</p> <p>11851290</p> <p>11851291</p> |

| ILLUSTRATION NOT TO SCALE | DESCRIPTION | COLOR | PART NO. |
|--|---|-------|----------|
|  | <p>Wood 130" Mull Kit – 1" x 4 9/16" LVL</p> <p><i>Includes:</i></p> <p>1 – W8677 Mull Post, 130" (3302) – 30251199 (a)</p> <p>1 – Non Finger-Jointed 5/4 Flat Casing – 30240130, W9201(b)</p> <p>24 – #8–15x1 1/4" Flat Head Screws–11808114(c)</p> <p>12 – 10" Masonry Clips– 11860013 (d)</p> <p>12 – 6" Masonry Clips –11860012 (d)</p> <p>1 – Interior Mull Trim – 30803399 (e)</p> <p>24 – #8–15x 5/8" Flat Head Screws–11800499(f)</p> <p>Mulling Instructions – 19970066</p> <p>Masonry Clip Instructions – 11708266</p> | | 11851127 |

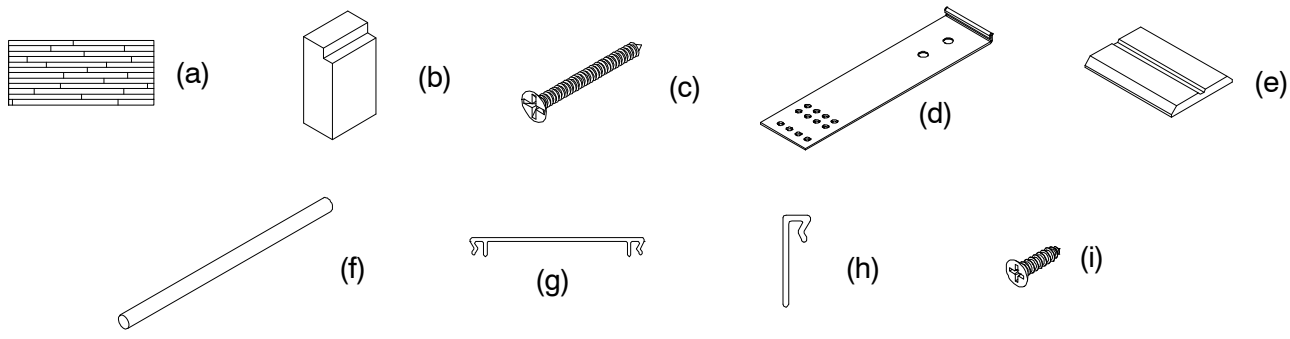

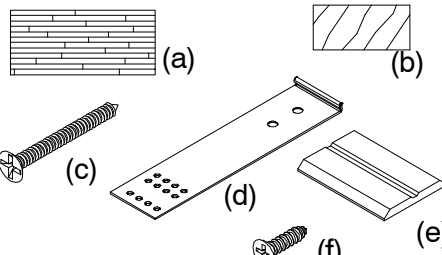
| ILLUSTRATION NOT TO SCALE | | |
|--|---|---|
|  | | |
| DESCRIPTION | COLOR | PART NO. |
| <p>Clad 130" Mull Kit – 2" x 4 9/16" LVL</p> <p><i>Includes:</i></p> <p>1 – W11748 Mull Post, 130" (3302) – 30241200 (a)</p> <p>1 – Mull Sealant Blocks – 10500018(b)</p> <p>24 – #8–15x1 1/4" Flat Head Screws–11808114(c)</p> <p>12 –10" Masonry Clips –11860013 (d)</p> <p>12 –6" Masonry Clips –11860012 (d)</p> <p>1 – W11329 Interior Mull Trim – 30385099(e)</p> <p>1 – Frame Kerf Weather Strip, 260" (6604) length – M1242 (f)</p> <p>1 – A112 2" Space Mull Cover (g)</p> <p>BN – 18600660 BZ – 18600680</p> <p>PB – 18600670 EG – 18600690</p> <p>SW – 18800900</p> <p>2 – A148 Frame Trim (h)</p> <p>BN – 15224810 BZ – 15224830</p> <p>PB – 15224820 EG – 15224840</p> <p>SW – 18801440</p> <p>24 –#8–15x 5/8" Flat Head Screws–11800499(i)</p> <p>Mulling Instructions – 19970066</p> <p>Masonry Clip Instructions – 11708266</p> | <p>Brown</p> <p>Pebble</p> <p>Bronze</p> <p>Evergreen</p> <p>Stone White</p> <p>Wineberry</p> <p>Ebony</p> <p>Cashmere</p> <p>Cadet Gray</p> <p>Coconut Cream</p> <p>Cascade Blue</p> <p>Hampton Sage</p> <p>Sierra White</p> <p>Copper</p> <p>Bright Silver</p> <p>Clay</p> <p>Gunmetal</p> <p>Liberty Bronze</p> <p>Suede</p> | <p>11851222</p> <p>11851223</p> <p>11851224</p> <p>11851225</p> <p>11851226</p> <p>11851236</p> <p>11851238</p> <p>11851239</p> <p>11851241</p> <p>11851242</p> <p>11851243</p> <p>11851244</p> <p>11851245</p> <p>11851246</p> <p>11851247</p> <p>11851264</p> <p>11851265</p> <p>11851266</p> <p>11851267</p> |

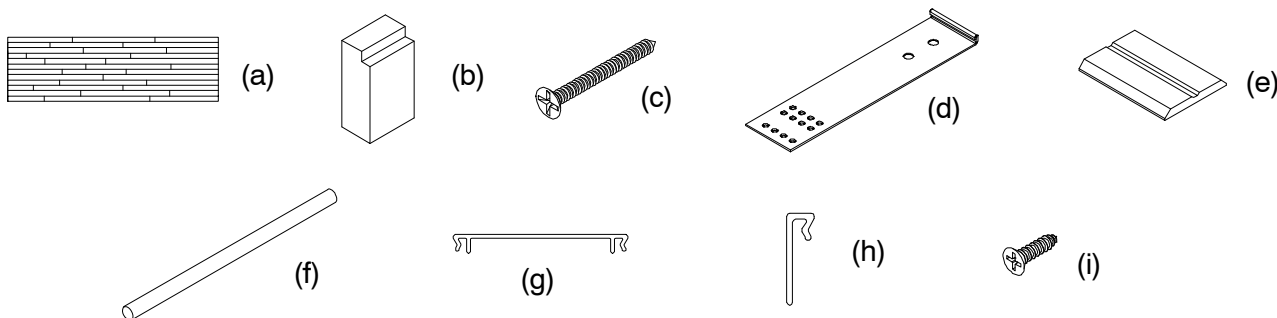
| ILLUSTRATION NOT TO SCALE | DESCRIPTION | COLOR | PART NO. |
|---|---|-------|-----------------|
|  | <p>Wood 130" Mull Kit – 2" x 4 9/16" LVL</p> <p><i>Includes:</i></p> <p>1 – W11748 Mull Post, 130" (3302) – 30241200 (a)</p> <p>1 – Non Finger-Jointed 5/4 Flat Casing – W12481(b)</p> <p>24 –#8–15x1 1/4" Flat Head Screws–11808114(c)</p> <p>12 –10" Masonry Clips 11860013 (d)</p> <p>12 – 6" Masonry Clips –11860012 (d)</p> <p>1 – W11329 Interior Mull Trim – 30385099(e)</p> <p>24 –#8–15x 5/8" Flat Head Screws–11800499(f)</p> <p>Mulling Instructions – 19970066</p> <p>Masonry Clip Instructions – 11708266</p> | | <p>11851227</p> |

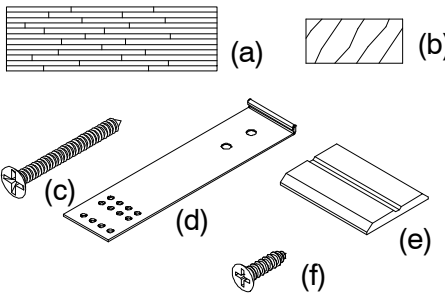
| ILLUSTRATION NOT TO SCALE | | |
|--|---|---|
|  | | |
| DESCRIPTION | COLOR | PART NO. |
| <p>Clad 130" Mull Kit – 2" x 6 9/16" LVL</p> <p><i>Includes:</i></p> <p>1 – W10186 Mull Post, 130" (3302) – 30241199(a) W10186 Mull Post (FSC – 30241299(a))</p> <p>1 – Mull Sealant Blocks – 10500018(b)</p> <p>24 – #8–15x1 1/4" Flat Head Screws–11808114(c)</p> <p>12 – 10" Masonry Clips– 11860013 (d)</p> <p>1 – W11329 Interior Mull Trim – 30385099(e)</p> <p>1 – Frame Kerf Weather Strip, 260" (6604) length M1242 (f)</p> <p>1 – A112 2" Space Mull Cover (g)</p> <p>BN – 18600660 BZ – 18600680</p> <p>PB – 18600670 EG – 18600690</p> <p>SW – 18800900</p> <p>2 – A148 Frame Trim (h)</p> <p>BN – 15224810 BZ – 15224830</p> <p>PB – 15224820 EG – 15224840</p> <p>SW – 18801440</p> <p>24 – #8–15x 5/8" Flat Head Screws–11800499(i)</p> <p>Mulling Instructions – 19970066</p> <p>Masonry Clip Instructions – 11708266</p> | <p>Stone White</p> <p>Bronze</p> <p>Pebble</p> <p>Brown</p> <p>Evergreen</p> <p>Wineberry</p> <p>Ebony</p> <p>Cashmere</p> <p>Coconut Cream</p> <p>Cadet Gray</p> <p>Cascade Blue</p> <p>Hampton Sage</p> <p>Sierra White</p> <p>Bright Silver</p> <p>Copper</p> <p>Clay</p> <p>Gunmetal</p> <p>Liberty Bronze</p> <p>Suede</p> | <p>11851232</p> <p>11851230</p> <p>11851229</p> <p>11851228</p> <p>11851231</p> <p>11851250</p> <p>11851252</p> <p>11851253</p> <p>11851256</p> <p>11851255</p> <p>11851257</p> <p>11851258</p> <p>11851259</p> <p>11851261</p> <p>11851260</p> <p>11851268</p> <p>11851269</p> <p>11851270</p> <p>11851271</p> |

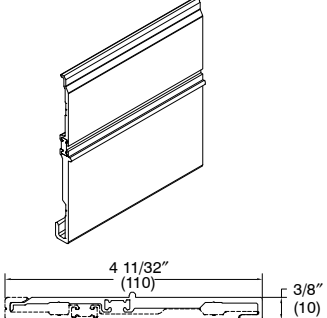
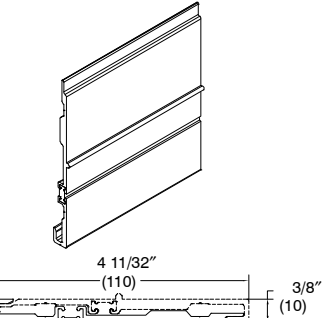
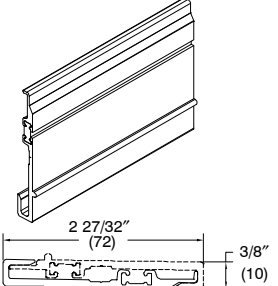
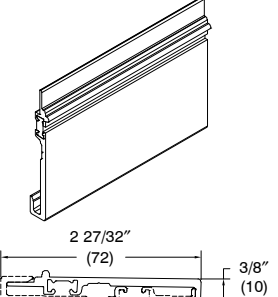
| ILLUSTRATION NOT TO SCALE | DESCRIPTION | COLOR | PART NO. |
|---|--|-------|----------|
|  | <p>Wood 130" Mull Kit – 2" x 6 9/16" LVL</p> <p><i>Includes:</i></p> <p>1 – W10186 Mull Post, 130" (3302) – 30241199(a) W10186 Mull Post (FSC – 30241299(a))</p> <p>1 – Non Finger-Jointed 5/4 Flat Casing – W12481(b)</p> <p>24 – #8–15x1 1/4" Flat Head Screws–11808114(c)</p> <p>12 – 10" Masonry Clips –11860013 (d)</p> <p>1 – W11329 Interior Mull Trim – 30385099(e)</p> <p>24 – #8–15x 5/8" Flat Head Screws–11800499(f)</p> <p>Mulling Instructions – 19970066</p> <p>Masonry Clip Instructions – 11708266</p> | | 11851233 |

| ILLUSTRATION NOT TO SCALE | DESCRIPTION | COLOR | PART NO. |
|---|---|-------|----------|
|  | <p>3/8" Aluminum MRF –RH Jamb and Header A3177</p> <p>200" (5080)</p> | Beige | 18817110 |
|  | <p>3/8" Aluminum MRF LH Jamb and Sill A3273</p> <p>200" (5080)</p> | Black | 18817115 |
|  | <p>Narrow Frame Alum MRF – RH Jamb and Header A3198</p> <p>200" (5080)</p> | Beige | 18817100 |
|  | <p>Narrow Frame Alum MRF– LH Jamb and Sill A3274</p> <p>200" (5080)</p> | Black | 18817105 |

| | | |
|--|----------------|-----------------|
| <p>Silicone Tubes (Each)</p>  | Color | Part No. |
| | Stone White | 11407102 |
| | Bronze | 11407053 |
| | Pebble | 11407052 |
| | Brown | 11407051 |
| | Evergreen | 11407054 |
| | Wineberry | 11407101 |
| | Ebony | 11407058 |
| | Cashmere | 11407200 |
| | Coconut Cream | 11407135 |
| | Cadet Gray | 11407136 |
| | Cascade Blue | 11407137 |
| | Hampton Sage | 11407138 |
| | Sierra White | 11407206 |
| | Bright Silver | 11407201 |
| | Copper | Same as Brown |
| | Clay | 11407128 |
| | Gunmetal | 11407127 |
| | Liberty Bronze | Same as Bronze |
| | Suede | 11407126 |
| <p>Silicone Tubes (case of 20 tubes)</p>  | Color | Part No. |
| | Stone White | 11407089 |
| | Bronze | 11407098 |
| | Pebble | 11407097 |
| | Brown | 11407096 |
| | Evergreen | 11407099 |

* Available for a limited time.

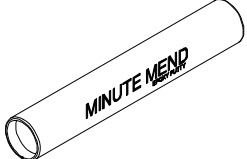
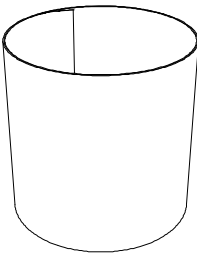
| ILLUSTRATION NOT TO SCALE | DESCRIPTION | COLOR | PART NO. |
|---|---|---|--|
|  | Minute Mend Putty 4 oz. tube | | 11410007 |
|  | Coil Stock, 18" Width .024 roll form aluminum supplied in 50 foot rolls, colors listed are per side (example - #15221312 has 1 bronze side and 1 brown side). 12" and 24" widths are not available. | Bronze-Brown Evergreen-Wineberry Stone White Coconut Cream-Ebony Hampton Sage-Sierra White Cashmere-Cadet Gray Bright Silver-Copper Liberty Bronze-Cascade Blue Clay-Suede Gunmetal-Pebble | 15221312 15221309 15221314 15221329 15221318 15221320 15221325 15221328 15221327 15221326 |

| <p>Exterior Clad Touch Up Paint – Brush .6 oz.</p>  | Color | Part No. |
|--|----------------|-----------------|
| | Stone White | 01530322 |
| | Bronze | 01530326 |
| | Pebble | 01530323 |
| | Brown | 01530325 |
| | Evergreen | 01530324 |
| | Wineberry | 01530331 |
| | Ebony | 01530330 |
| | Cashmere | 01530336 |
| | Coconut Cream | 01530338 |
| | Cadet Gray | 01530339 |
| | Cascade Blue | 01530327 |
| | Hampton Sage | 01530340 |
| | Sierra White | 01530341 |
| | Bright Silver | 01530346 |
| | Copper | 01530347 |
| | Clay | 01530350 |
| | Gunmetal | 01530349 |
| | Liberty Bronze | 01530348 |
| | Suede | 01530351 |

* Available for a limited time.

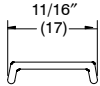
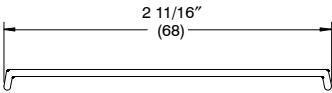
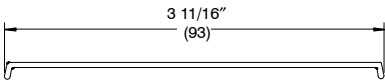
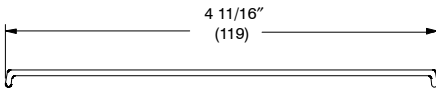
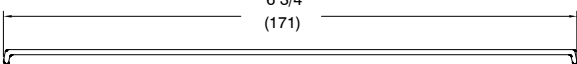
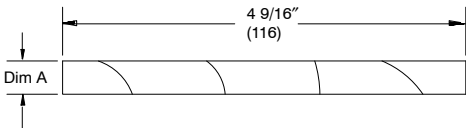

| Illustrations (Not to Scale) | Description | Color | Part No. |
|---|--|---|--|
|  | Touch Up Paint Ultrex Sill | Beige | 11406026 |
| | Painted Interior Finish Touch Up .75 oz bottle | White Designer Black | 11401907 11401919 |
| | Clear Interior Finish Touch Up .75 oz bottle | Clear | 11401918 |
| | Stain Interior Finish Touch Up .6 oz bottle | Wheat Honey Leather Hazelnut Cabernet Espresso | 11402300 11402301 11402302 11402303 11402304 11402305 |

| ILLUSTRATION NOT TO SCALE | DESCRIPTION | COLOR | PART NO. | | | | | | | | | | | | | | | | | | | | | | | | | | | | |
|---|---|---|--|-------|--|-------|------|------|----------|-------|----|------|----------|-------|----|-------|----------|-------|----|-------|----------|-------|----|-------|----------|-------|----|-------|----------|--|--|
|  | Field Service Mullion Clip Cap (For direct mullion) A334 150" (3810) | Stone White Bronze Pebble Brown Evergreen | 18609660 18609640 18609630 18609620 18609650 | | | | | | | | | | | | | | | | | | | | | | | | | | | | |
|  | Field Service Mullion Clip Cap (For 2" mullion) A320 150" (3810) | Stone White Bronze Pebble Brown Evergreen | 18609599 18609399 18609299 18609199 18609499 | | | | | | | | | | | | | | | | | | | | | | | | | | | | |
|  | Field Service Mullion Clip Cap (For 3" mullion) A331 150" (3810) | Stone White Bronze Pebble Brown Evergreen | 18609760 18609740 18609730 18609720 18609750 | | | | | | | | | | | | | | | | | | | | | | | | | | | | |
|  | Field Service Mullion Clip Cap 4" (102) A332 150" (3810) | Stone White Bronze Pebble Brown Evergreen | 18609860 18609840 18609830 18609820 18609850 | | | | | | | | | | | | | | | | | | | | | | | | | | | | |
|  | Field Service Mullion Clip Cap 6" (152) A1487 150" (3810) | Stone White Bronze Pebble Brown Evergreen | 18881010 18881006 18881004 18881002 18881008 | | | | | | | | | | | | | | | | | | | | | | | | | | | | |
|  | Stud Pocket, Space Mull and Solid Space Mull Blocking 72" (1829) <table border="0" style="width: 100%;"> <thead> <tr> <th></th> <th style="text-align: center;">Width</th> <th style="text-align: center;">Dim A</th> <th></th> </tr> </thead> <tbody> <tr> <td style="text-align: right;">W6016</td> <td style="text-align: center;">3/8"</td> <td style="text-align: center;">.375</td> <td style="text-align: right;">32249310</td> </tr> <tr> <td style="text-align: right;">W6128</td> <td style="text-align: center;">1"</td> <td style="text-align: center;">.969</td> <td style="text-align: right;">32249312</td> </tr> <tr> <td style="text-align: right;">W6271</td> <td style="text-align: center;">2"</td> <td style="text-align: center;">1.969</td> <td style="text-align: right;">32249314</td> </tr> <tr> <td style="text-align: right;">W8917</td> <td style="text-align: center;">2"</td> <td style="text-align: center;">2.000</td> <td style="text-align: right;">32249336</td> </tr> <tr> <td style="text-align: right;">W6304</td> <td style="text-align: center;">3"</td> <td style="text-align: center;">2.969</td> <td style="text-align: right;">32249316</td> </tr> <tr> <td style="text-align: right;">W6466</td> <td style="text-align: center;">4"</td> <td style="text-align: center;">3.969</td> <td style="text-align: right;">32249318</td> </tr> </tbody> </table> | | Width | Dim A | | W6016 | 3/8" | .375 | 32249310 | W6128 | 1" | .969 | 32249312 | W6271 | 2" | 1.969 | 32249314 | W8917 | 2" | 2.000 | 32249336 | W6304 | 3" | 2.969 | 32249316 | W6466 | 4" | 3.969 | 32249318 | | |
| | Width | Dim A | | | | | | | | | | | | | | | | | | | | | | | | | | | | | |
| W6016 | 3/8" | .375 | 32249310 | | | | | | | | | | | | | | | | | | | | | | | | | | | | |
| W6128 | 1" | .969 | 32249312 | | | | | | | | | | | | | | | | | | | | | | | | | | | | |
| W6271 | 2" | 1.969 | 32249314 | | | | | | | | | | | | | | | | | | | | | | | | | | | | |
| W8917 | 2" | 2.000 | 32249336 | | | | | | | | | | | | | | | | | | | | | | | | | | | | |
| W6304 | 3" | 2.969 | 32249316 | | | | | | | | | | | | | | | | | | | | | | | | | | | | |
| W6466 | 4" | 3.969 | 32249318 | | | | | | | | | | | | | | | | | | | | | | | | | | | | |

When ordering obsolete replacement installation accessories specify:

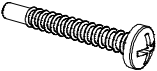
1. part number;
2. description;
3. length (if applicable).

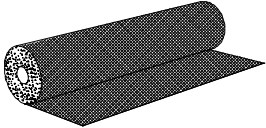
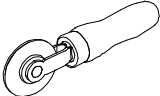
| ILLUSTRATION <i>NOT TO SCALE</i> | DESCRIPTION | COLOR | PART NO. |
|---|--|-------|----------|
|  | <p>Nailing Fin – Sill and Subsill – Clad Brick Mould Casing V084</p> <p style="text-align: center;">144" (3658)</p> | Beige | 16217299 |
|  | <p>Screw – Subsill to Jamb – Clad Brick Mould Casing #8x1 1/4" Phillips panhead lead point screw</p> | ZYD | 11800825 |

| ILLUSTRATION NOT TO SCALE | DESCRIPTION | OPER./ COLOR | PART NO. |
|---|--|-----------------|--|
|  | Screen Cloth, Fiberglass Mesh 36" x 600' 48" x 300' 72" x 300' | Charcoal | 11253600 11254800 11257200 |
| | Screen Cloth, High Transparency Screen Mesh 24" x 600' 36" x 600' 48" x 600' 60" x 600' 72" x 600' | Charcoal | 11259124 11259136 11259148 11259160 11259172 |
|  | Spline Roller Tool for rescreening | | 02590541 |
|  | Spline, Screen for Upgraded Magnum Screen V2176 – .150 inch diameter, foam Specify lineal feet needed | Black | 15221496 |
|  | Spline, Screen for Standard Screen V201 – .140 inch diameter, foam Specify lineal feet needed | Black | 15221488 |

Corner Moulding, Sash, A1848
 For UCA 90 Deg Corner Unit
 150" (3810)

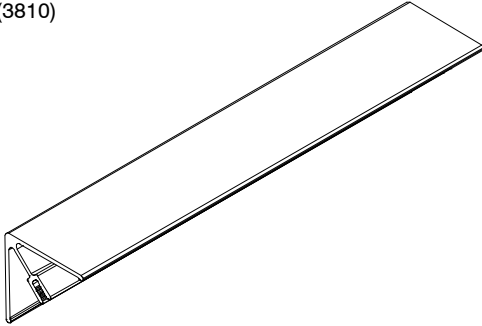

| Color | Part No. |
|----------------|----------|
| Stone White | 18505510 |
| Bronze | 18505506 |
| Pebble | 18505504 |
| Brown | 18505502 |
| Evergreen | 18505508 |
| Wineberry | 18505514 |
| Ebony | 18505518 |
| Cashmere | 18505520 |
| Coconut Cream | 18505526 |
| Cadet Gray | 18505526 |
| Cascade Blue | 18505528 |
| Hampton Sage | 18505530 |
| Sierra White | 18505532 |
| Bright Silver | 18861124 |
| Copper | 18505534 |
| Clay | 18505546 |
| Gunmetal | 18505542 |
| Liberty Bronze | 18505540 |
| Suede | 18505544 |

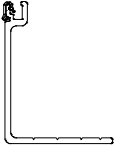
| <p>Frame Extender, A1530 For Ultimate Casement/Awning Narrow Frame 150" (3810)</p>  | Color | Part No. |
|---|----------------|-----------------|
| | Stone White | 18653210 |
| | Bronze | 18653206 |
| | Pebble | 18653204 |
| | Brown | 18653202 |
| | Evergreen | 18653208 |
| | Wineberry | 18653216 |
| | Ebony | 18653218 |
| | Cashmere | 18653220 |
| | Coconut Cream | 18653226 |
| | Cadet Gray | 18653228 |
| | Cascade Blue | 18653230 |
| | Hampton Sage | 18653232 |
| | Sierra White | 18653234 |
| | Bright Silver | 18861354 |
| | Copper | 18861352 |
| | Clay | 18873944 |
| | Gunmetal | 18873940 |
| | Liberty Bronze | 18873938 |
| | Suede | 18873942 |

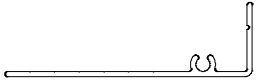
| <p>Clad Sill Cover, A1193 150" (3810)</p>  | Color | Part No. |
|---|--------------|-----------------|
| | Stone White | 18580599 |
| | Bronze | 18580399 |
| | Pebble | 18580299 |
| | Brown | 18580199 |
| | Evergreen | 18580499 |

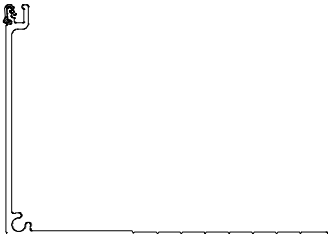
| <p>Adjustable Masonry Panning, A1531 For Ultimate Casement/Awning Narrow Frame 150" (3810)</p>  | Color | Part No. |
|---|----------------|----------|
| | Stone White | 18653110 |
| | Bronze | 18653106 |
| | Pebble | 18653104 |
| | Brown | 18653102 |
| | Evergreen | 18653108 |
| | Wineberry | 18653116 |
| | Ebony | 18653118 |
| | Cashmere | 18653120 |
| | Coconut Cream | 18653126 |
| | Cadet Gray | 18653128 |
| | Cascade Blue | 18653130 |
| | Hampton Sage | 18653132 |
| | Sierra White | 18653134 |
| | Bright Silver | 18861022 |
| | Copper | 18861020 |
| | Clay | 18873952 |
| | Gunmetal | 18873948 |
| | Liberty Bronze | 18873946 |
| | Suede | 18873950 |

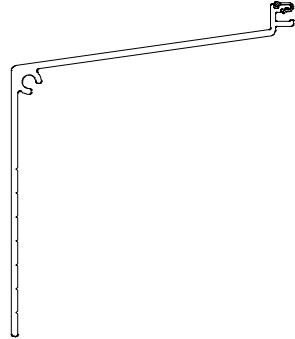
| <p>Sill Panning, A1532 For Ultimate Casement/Awning Narrow Frame 150" (3810)</p>  | Color | Part No. |
|---|----------------|----------|
| | Stone White | 18653010 |
| | Bronze | 18653006 |
| | Pebble | 18653004 |
| | Brown | 18653002 |
| | Evergreen | 18653008 |
| | Wineberry | 18653016 |
| | Ebony | 18653018 |
| | Cashmere | 18653020 |
| | Coconut Cream | 18653026 |
| | Cadet Gray | 18653028 |
| | Cascade Blue | 18653030 |
| | Hampton Sage | 18653032 |
| | Sierra White | 18653034 |
| | Bright Silver | 18861602 |
| | Copper | 18861600 |
| | Clay | 18873960 |
| | Gunmetal | 18873956 |
| | Liberty Bronze | 18873954 |
| | Suede | 18873958 |

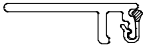
| <p>3/4" Panning, A1533 For Ultimate Casement/Awning Narrow Frame 150" (3810)</p>  | Color | Part No. |
|---|----------------|----------|
| | Stone White | 18651110 |
| | Bronze | 18651106 |
| | Pebble | 18651104 |
| | Brown | 18651102 |
| | Evergreen | 18651108 |
| | Wineberry | 18651116 |
| | Ebony | 18651118 |
| | Cashmere | 18651120 |
| | Coconut Cream | 18651126 |
| | Cadet Gray | 18651128 |
| | Cascade Blue | 18651130 |
| | Hampton Sage | 18651132 |
| | Sierra White | 18651134 |
| | Bright Silver | 18861418 |
| | Copper | 18861416 |
| | Clay | 18873968 |
| | Gunmetal | 18843964 |
| | Liberty Bronze | 18873962 |
| | Suede | 18873966 |

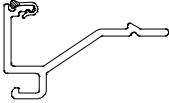
| <p>Sill Riser, A1557 For Ultimate Casement/Awning Narrow Frame 150" (3810)</p>  | Color | Part No. |
|---|----------------|----------|
| | Stone White | 18654010 |
| | Bronze | 18654006 |
| | Pebble | 18654004 |
| | Brown | 18654002 |
| | Evergreen | 18654008 |
| | Wineberry | 18654016 |
| | Ebony | 18654018 |
| | Cashmere | 18654020 |
| | Coconut Cream | 18654026 |
| | Cadet Gray | 18654028 |
| | Cascade Blue | 18654030 |
| | Hampton Sage | 18654032 |
| | Sierra White | 18654034 |
| | Bright Silver | 18861578 |
| | Copper | 18861576 |
| | Clay | 18872622 |
| | Gunmetal | 18872618 |
| | Liberty Bronze | 18872616 |
| | Suede | 18872620 |

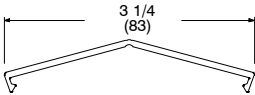
| <p>Clad Mull Cap, 30 Degree Bay, A122 150" (3810)</p>  | Color | Part No. |
|--|----------------|-----------------|
| | Stone White | 18604105 |
| | Bronze | 18603026 |
| | Pebble | 18603025 |
| | Brown | 18603015 |
| | Evergreen | 18603027 |
| | Wineberry | 18801030 |
| | Ebony | 18801032 |
| | Cashmere | 19000130 |
| | Coconut Cream | 19003130 |
| | Cadet Gray | 19004130 |
| | Cascade Blue | 19005130 |
| | Hampton Sage | 19006130 |
| | Sierra White | 19007130 |
| | Bright Silver | 18861178 |
| | Copper | 18861176 |
| | Clay | 18872110 |
| | Gunmetal | 18872106 |
| | Liberty Bronze | 18872104 |
| | Suede | 18872108 |

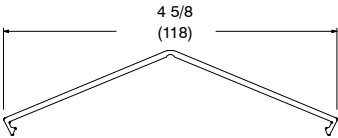
| <p>Clad Mull Cap, 45 Degree Bay, A123 Description 150" (3810)</p>  | Color | Part No. |
|--|----------------|-----------------|
| | Stone White | 18604115 |
| | Bronze | 18603066 |
| | Pebble | 18603065 |
| | Brown | 18603055 |
| | Evergreen | 18603067 |
| | Wineberry | 18801050 |
| | Ebony | 18801052 |
| | Cashmere | 19000132 |
| | Coconut Cream | 19003132 |
| | Cadet Gray | 19004132 |
| | Cascade Blue | 19005132 |
| | Hampton Sage | 19006132 |
| | Sierra White | 19007132 |
| | Bright Silver | 18861034 |
| | Copper | 18861032 |
| | Clay | 18872118 |
| | Gunmetal | 18872114 |
| | Liberty Bronze | 18872112 |
| | Suede | 18872116 |

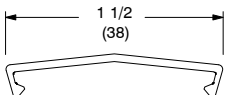
| <p>Clad Mull Cap, 6 Degree Bow, A124 150" (3810)</p>  | Color | Part No. |
|---|----------------|-----------------|
| | Stone White | 18604125 |
| | Bronze | 18604015 |
| | Pebble | 18604005 |
| | Brown | 18603095 |
| | Evergreen | 18604025 |
| | Wineberry | 18801070 |
| | Ebony | 18801072 |
| | Cashmere | 19000134 |
| | Coconut Cream | 19003134 |
| | Cadet Gray | 19004134 |
| | Cascade Blue | 19005134 |
| | Hampton Sage | 19006134 |
| | Sierra White | 19007134 |
| | Bright Silver | 18861038 |
| | Copper | 18861036 |
| | Clay | 18872126 |
| | Gunmetal | 18872122 |
| | Liberty Bronze | 18872120 |
| | Suede | 18872124 |

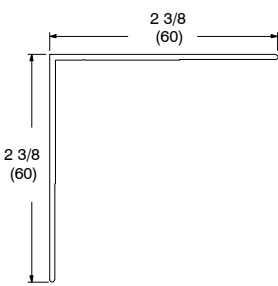
| <p>Corner Cover/Cap, A127 90 Degree Bays 150" (3810)</p>  | Color | Part No. |
|---|----------------|-----------------|
| | Stone White | 18604061 |
| | Bronze | 18604059 |
| | Pebble | 18604058 |
| | Brown | 18604057 |
| | Evergreen | 18604060 |
| | Wineberry | 18801210 |
| | Ebony | 18801212 |
| | Cashmere | 19000136 |
| | Coconut Cream | 19003136 |
| | Cadet Gray | 19004136 |
| | Cascade Blue | 19005136 |
| | Hampton Sage | 19006136 |
| | Sierra White | 19007136 |
| | Bright Silver | 18861042 |
| | Copper | 18861040 |
| | Clay | 18872142 |
| | Gunmetal | 18872138 |
| | Liberty Bronze | 18872136 |
| | Suede | 18872140 |

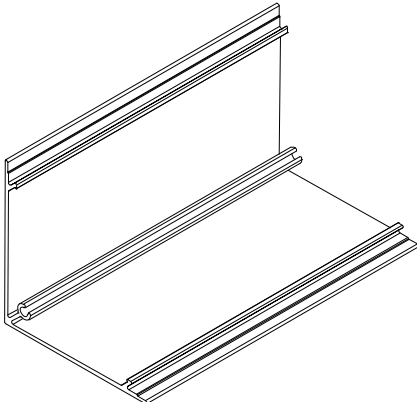
| <p>Corner Cap, – UDGCNR A3172 – 150" Measures 3" from outside of the corner to flat edge on both sides.</p>  | Color | Part No. |
|---|----------------|-----------------|
| | Stone White | 18620750 |
| | Bronze | 18620740 |
| | Pebble | 18620735 |
| | Brown | 18620730 |
| | Evergreen | 18620745 |
| | Wineberry | 18620755 |
| | Ebony | 18620760 |
| | Cashmere | 18620765 |
| | Coconut Cream | 18620770 |
| | Cadet Gray | 18620775 |
| | Cascade Blue | 18620780 |
| | Hampton Sage | 18620785 |
| | Sierra White | 18620790 |
| | Bright Silver | 18620705 |
| | Copper | 18620700 |
| | Clay | 18620725 |
| | Gunmetal | 18620715 |
| | Liberty Bronze | 18620710 |
| | Suede | 18620720 |

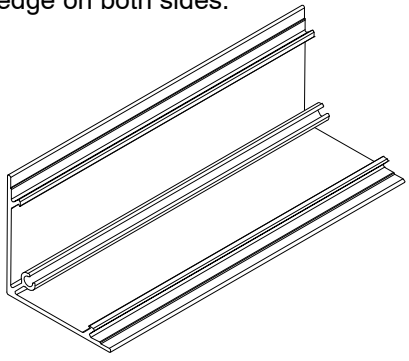
| <p>Corner Cap – Ultimate Direct Glaze Narrow Frame Corner DISC LA Contemporary, Ultimate Direct Glaze Narrow Frame Corner A3147 – 150" Measures 1 3/4" from outside of the corner to flat edge on both sides.</p>  | Color | Part No. |
|---|----------------|-----------------|
| | Stone White | 18816950 |
| | Bronze | 18816940 |
| | Pebble | 18816935 |
| | Brown | 18816930 |
| | Evergreen | 18816945 |
| | Wineberry | 18816955 |
| | Ebony | 18816960 |
| | Cashmere | 18816965 |
| | Coconut Cream | 18816970 |
| | Cadet Gray | 18816975 |
| | Cascade Blue | 18816980 |
| | Hampton Sage | 18816985 |
| | Sierra White | 18816990 |
| | Bright Silver | 18816905 |
| | Copper | 18816900 |
| | Clay | 18816925 |
| | Gunmetal | 18816915 |
| | Liberty Bronze | 18816910 |
| | Suede | 18816920 |

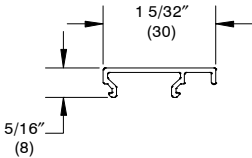
| <p>Jamb Filler, A197 150" (3810)</p>  | Color | Part No. |
|---|----------------|-----------------|
| | Stone White | 18801780 |
| | Bronze | 18561899 |
| | Pebble | 18561799 |
| | Brown | 18561699 |
| | Evergreen | 18561999 |
| | Wineberry | 18801790 |
| | Ebony | 18801792 |
| | Cashmere | 19000310 |
| | Coconut Cream | 19003310 |
| | Cadet Gray | 19004310 |
| | Cascade Blue | 19005310 |
| | Hampton Sage | 19006310 |
| | Sierra White | 19007310 |
| | Bright Silver | 18861318 |
| | Copper | 18861316 |
| | Clay | 18873640 |
| | Gunmetal | 18873636 |
| | Liberty Bronze | 18873634 |
| | Suede | 18873638 |

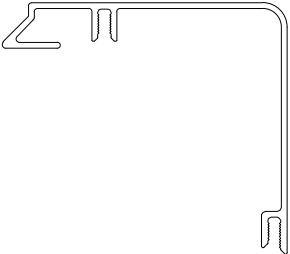
| <p>Top Sash Check Rail Cladding, A183 155" (3937) 191" (4851) **</p>  | Color | Part No. |
|---|----------------|-----------------|
| | Stone White | 18801799 |
| | Bronze | 18562398 |
| | Pebble | 18562298 |
| | Brown | 18562198 |
| | Evergreen | 18562498 |
| | Wineberry | 18801809 |
| | Ebony | 18801811 |
| | Cashmere | 19000302 |
| | Coconut Cream | 19003302 |
| | Cadet Gray | 19004302 |
| | Cascade Blue | 19005302 |
| | Hampton Sage | 19006302 |
| | Sierra White | 19007302 |
| | Bright Silver | 18861466** |
| | Copper | 18861464** |
| | Clay | 18872206** |
| | Gunmetal | 18872202** |
| | Liberty Bronze | 18872200** |
| | Suede | 18872204** |

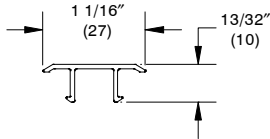
| <p>Jamb Filler, A216 150" (3810)</p>  | Color | Part No. |
|---|----------------|-----------------|
| | Stone White | 18801954 |
| | Bronze | 18564899 |
| | Pebble | 18564799 |
| | Brown | 18564699 |
| | Evergreen | 18564999 |
| | Wineberry | 18801966 |
| | Ebony | 18801958 |
| | Cashmere | 19000314 |
| | Coconut Cream | 19003314 |
| | Cadet Gray | 19004314 |
| | Cascade Blue | 19005314 |
| | Hampton Sage | 19006314 |
| | Sierra White | 19007314 |
| | Bright Silver | 18861310 |
| | Copper | 18861308 |
| | Clay | NA |
| | Gunmetal | NA |
| | Liberty Bronze | NA |
| | Suede | NA |

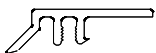
| <p>Glazing Cap, 9/16" IG, A174 150" (3810)</p>  | Color | Part No. |
|---|----------------|-----------------|
| | Stone White | 18800140 |
| | Bronze | 18606899 |
| | Pebble | 18606799 |
| | Brown | 18606699 |
| | Evergreen | 18606999 |
| | Wineberry | 18800150 |
| | Ebony | 18800152 |
| | Cashmere | 19000500 |
| | Coconut Cream | 19003500 |
| | Cadet Gray | 19004500 |
| | Cascade Blue | 19005500 |
| | Hampton Sage | 19006500 |
| | Sierra White | 19007500 |
| | Bright Silver | 18861366 |
| | Copper | 18861364 |
| | Clay | NA |
| | Gunmetal | NA |
| | Liberty Bronze | NA |
| | Suede | NA |

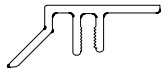
| <p>Glazing Cap, A178 150" (3810)</p>  | Color | Part No. |
|---|---------------|----------|
| | Stone White | 18800380 |
| | Bronze | 18607399 |
| | Pebble | 18607299 |
| | Brown | 18607199 |
| | Evergreen | 18607499 |
| | Wineberry | 18800390 |
| | Ebony | 18800392 |
| | Cashmere | 19000600 |
| | Coconut Cream | 19003600 |
| | Cadet Gray | 19004600 |
| | Cascade Blue | 19005600 |
| | Hampton Sage | 19006600 |
| | Sierra White | 19007600 |
| | Bright Silver | 18861370 |
| | Copper | 18861368 |
| | Clay | NA |
| | Gunmetal | NA |
| Liberty Bronze | NA | |
| Suede | NA | |

| <p>Stationary Sash Filler Cap, A510 150" (3810)</p>  | Color | Part No. |
|--|---------------|----------|
| | Stone White | 18801984 |
| | Bronze | 18536399 |
| | Pebble | 18536299 |
| | Brown | 18566199 |
| | Evergreen | 18536499 |
| | Wineberry | 18801988 |
| | Ebony | 18801990 |
| | Cashmere | 19000630 |
| | Coconut Cream | 19003630 |
| | Cadet Gray | 19004630 |
| | Cascade Blue | 19005630 |
| | Hampton Sage | 19006630 |
| | Sierra White | 19007630 |
| | Bright Silver | 18861058 |
| | Copper | 18861056 |
| | Clay | NA |
| | Gunmetal | NA |
| Liberty Bronze | NA | |
| Suede | NA | |

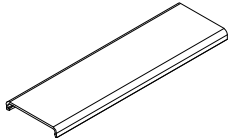
| <p>Edge Cover–Meeting Stile, A778 USFD, USPD 162" (4115) 190" (4826) **</p>  | Color | Part No. |
|---|---------------|-----------------|
| | Stone White | 18419998 |
| | Bronze | 18419899 |
| | Pebble | 18419799 |
| | Brown | 18419699 |
| | Evergreen | 18419999 |
| | Wineberry | 18764599 |
| | Ebony | 18764699 |
| | Cashmere | 19000860 |
| | Coconut Cream | 19003860 |
| | Cadet Gray | 19004860 |
| | Cascade Blue | 19005860 |
| | Hampton Sage | 19006860 |
| | Sierra White | 19007860 |
| | Bright Silver | 18709737** |
| | Copper | 18709738** |
| | Clay | 18873528** |
| | Gunmetal | 18873524** |
| Liberty Bronze | 18873522** | |
| Suede | 18873526** | |

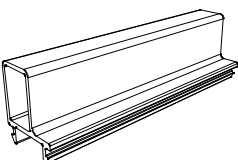
| <p>Mull Cover with Screen Stop, A776 UIFD 166" (4216) 193" (4902) **</p>  | Color | Part No. |
|--|---------------|-----------------|
| | Stone White | 18709628** |
| | Bronze | 18446003 |
| | Pebble | 18446002 |
| | Brown | 18446001 |
| | Evergreen | 18446004 |
| | Wineberry | 18757599 |
| | Ebony | 18757699 |
| | Cashmere | 19000856 |
| | Coconut Cream | 19003856 |
| | Cadet Gray | 19004856 |
| | Cascade Blue | 19005856 |
| | Hampton Sage | 19006856 |
| | Sierra White | 19007856 |
| | Bright Silver | 18709639** |
| | Copper | 18709640** |
| | Clay | 18873520** |
| | Gunmetal | 18873516** |
| Liberty Bronze | 18873514** | |
| Suede | 18873518** | |

| <p>Mull Casing Cover, A775 UIFD 192" (4877)</p>  | Color | Part No. |
|--|----------------|-----------------|
| | Stone White | 18709534 |
| | Bronze | 18709520 |
| | Pebble | 18709530 |
| | Brown | 18709518 |
| | Evergreen | 18709528 |
| | Wineberry | 18709536 |
| | Ebony | 18709526 |
| | Cashmere | 18709524 |
| | Coconut Cream | 18709522 |
| | Cadet Gray | 18709506 |
| | Cascade Blue | 18709504 |
| | Hampton Sage | 18709514 |
| | Sierra White | 18708532 |
| | Bright Silver | 18709539 |
| | Copper | 18709540 |
| | Clay | 18873512 |
| | Gunmetal | 18873508 |
| | Liberty Bronze | 18873506 |
| | Suede | 18873510 |

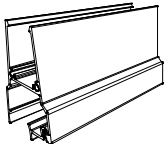
| <p>Mull Casing, A773 UIFD 165" (4191) 192" (4877)**</p>  | Color | Part No. |
|---|----------------|-----------------|
| | Stone White | 18754099 |
| | Bronze | 18443003 |
| | Pebble | 18443002 |
| | Brown | 18443001 |
| | Evergreen | 18443004 |
| | Wineberry | 18754599 |
| | Ebony | 18754699 |
| | Cashmere | 19000852 |
| | Coconut Cream | 19003852 |
| | Cadet Gray | 19004852 |
| | Cascade Blue | 19005852 |
| | Hampton Sage | 19006852 |
| | Sierra White | 19007852 |
| | Bright Silver | 18709437** |
| | Copper | 18709438** |
| | Clay | 18873504** |
| | Gunmetal | 18873500** |
| | Liberty Bronze | 18873498** |
| | Suede | 18873502** |

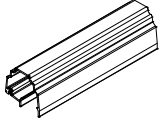
| <p>Astragal Cladding, A772 UIFD, UIFDTR, USFD, UIFD2.25, UIFD2.25AT 190" (4826)</p>  | Color | Part No. |
|--|----------------|-----------------|
| | Stone White | 18709306 |
| | Bronze | 18709324 |
| | Pebble | 18709334 |
| | Brown | 18709322 |
| | Evergreen | 18709330 |
| | Wineberry | 18709336 |
| | Ebony | 18709328 |
| | Cashmere | 18709314 |
| | Coconut Cream | 18709312 |
| | Cadet Gray | 18709310 |
| | Cascade Blue | 18709308 |
| | Hampton Sage | 19709316 |
| | Sierra White | 18709318 |
| | Bright Silver | 18709339 |
| | Copper | 18709340 |
| | Clay | 18873496 |
| | Gunmetal | 18873492 |
| | Liberty Bronze | 18873490 |
| | Suede | 18873494 |

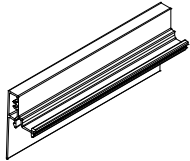
| <p>Mull Cap. Swinging Screen, A340 166" (4216)</p>  | Color | Part No. |
|--|----------------|-----------------|
| | Stone White | 18373308 |
| | Bronze | 18373304 |
| | Pebble | 18373303 |
| | Brown | 18373302 |
| | Evergreen | 18373305 |
| | Wineberry | 18373310 |
| | Ebony | 18373314 |
| | Cashmere | 19000822 |
| | Coconut Cream | 19003822 |
| | Cadet Gray | 18004822 |
| | Cascade Blue | 19005822 |
| | Hampton Sage | 19006822 |
| | Sierra White | 19007822 |
| | Bright Silver | 18373202 |
| | Copper | 18373203 |
| | Clay | 18873440 |
| | Gunmetal | 18873436 |
| | Liberty Bronze | 18873434 |
| | Suede | 18873438 |

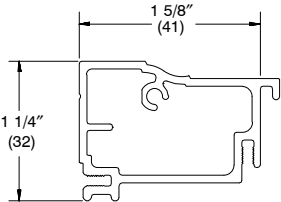
| <p>BMC, 1 5/8", A228 192" (4877)</p> <p>Note: Must also use accessory kerf weather strip and connecting barb V087 – frame</p>  | Color | Part No. |
|---|----------------|----------|
| | Stone White | 18801500 |
| | Bronze | 18612897 |
| | Pebble | 18612797 |
| | Brown | 18612697 |
| | Evergreen | 18612997 |
| | Wineberry | 18801510 |
| | Ebony | 18801512 |
| | Cashmere | 19000412 |
| | Coconut Cream | 19003412 |
| | Cadet Gray | 19004412 |
| | Cascade Blue | 19005412 |
| | Hampton Sage | 19006412 |
| | Sierra White | 19007412 |
| | Bright Silver | 18861026 |
| | Copper | 18861024 |
| | Clay | 18872262 |
| | Gunmetal | 18872258 |
| | Liberty Bronze | 18872256 |
| | Suede | 18872260 |

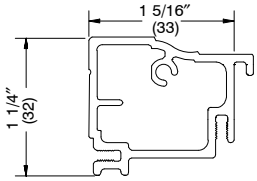
| <p>BMC, A898 192" (4877)</p> <p>Note: Must also use accessory kerf weather strip and connecting barb V087 – frame</p>  | Color | Part No. |
|---|----------------|----------|
| | Stone White | 18802142 |
| | Bronze | 18613735 |
| | Pebble | 18613725 |
| | Brown | 18613715 |
| | Evergreen | 18613745 |
| | Wineberry | 18802144 |
| | Ebony | 18802140 |
| | Cashmere | 19000432 |
| | Coconut Cream | 19003432 |
| | Cadet Gray | 19004432 |
| | Cascade Blue | 19005432 |
| | Hampton Sage | 19006432 |
| | Sierra White | 19007432 |
| | Bright Silver | 19002435 |
| | Copper | 19008435 |
| | Clay | 18872318 |
| | Gunmetal | 18872314 |
| | Liberty Bronze | 18872312 |
| | Suede | 18872316 |

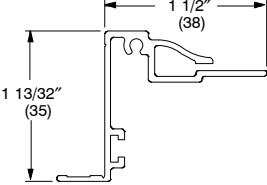
| <p>Adjustable Clad Brick Mould Casing, A130 150" (3810)</p>  | Color | Part No. |
|--|----------------|-----------------|
| | Stone White | 18802205 |
| | Bronze | 18601720 |
| | Pebble | 18601710 |
| | Brown | 18601700 |
| | Evergreen | 18601725 |
| | Wineberry | 18802200 |
| | Ebony | 18802220 |
| | Cashmere | 19000162 |
| | Coconut Cream | 19003162 |
| | Cadet Gray | 19004162 |
| | Cascade Blue | 19005162 |
| | Hampton Sage | 19006162 |
| | Sierra White | 19007162 |
| | Bright Silver | 18861018 |
| | Copper | 18861016 |
| | Clay | 18872936 |
| | Gunmetal | 18872932 |
| | Liberty Bronze | 18872930 |
| | Suede | 18872934 |

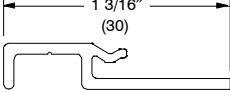
| <p>Sill Adapter, A129 150" (3810) Note: Use with A130</p>  | Color | Part No. |
|--|----------------|-----------------|
| | Stone White | 18804599 |
| | Bronze | 18601800 |
| | Pebble | 18601790 |
| | Brown | 18601780 |
| | Evergreen | 18601810 |
| | Wineberry | 18804595 |
| | Ebony | 18804598 |
| | Cashmere | 19000160 |
| | Coconut Cream | 19003160 |
| | Cadet Gray | 19004160 |
| | Cascade Blue | 19005160 |
| | Hampton Sage | 19006160 |
| | Sierra White | 19007160 |
| | Bright Silver | 18861010 |
| | Copper | 18861008 |
| | Clay | 18872928 |
| | Gunmetal | 18872924 |
| | Liberty Bronze | 18872922 |
| | Suede | 18872926 |

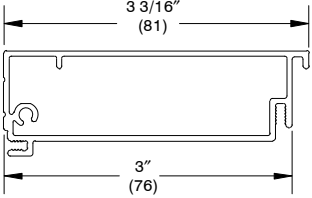
| | | |
|---|----------------|-----------------|
| <p>3" Flat Casing, A2754 200" (5080)</p>  | Color | Part No. |
| | Stone White | 19012925 |
| | Bronze | 19012915 |
| | Pebble | 19012910 |
| | Brown | 19012905 |
| | Evergreen | 19012920 |
| | Wineberry | 19012940 |
| | Ebony | 19012945 |
| | Cashmere | 19012950 |
| | Coconut Cream | 19012960 |
| | Cadet Gray | 19012965 |
| | Cascade Blue | 19012970 |
| | Hampton Sage | 19012975 |
| | Sierra White | 19012980 |
| | Bright Silver | 19012990 |
| | Copper | 19012985 |
| | Clay | 18872880 |
| | Gunmetal | 18872876 |
| | Liberty Bronze | 18872874 |
| | Suede | 18872878 |

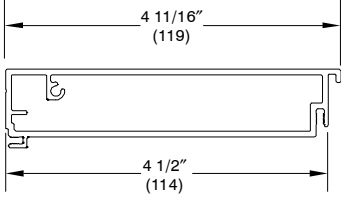
| | | |
|---|----------------|-----------------|
| <p>4 1/2" Flat Casing, A1444 200" (5080)</p>  | Color | Part No. |
| | Stone White | 18814410 |
| | Bronze | 18814406 |
| | Pebble | 18814404 |
| | Brown | 18814402 |
| | Evergreen | 18814408 |
| | Wineberry | 18814416 |
| | Ebony | 18814418 |
| | Cashmere | 1814420 |
| | Coconut Cream | 18814426 |
| | Cadet Gray | 18814428 |
| | Cascade Blue | 11814430 |
| | Hampton Sage | 18814432 |
| | Sierra White | 18814434 |
| | Bright Silver | 18861696 |
| | Copper | 18861698 |
| | Clay | 18872454 |
| | Gunmetal | 18872450 |
| | Liberty Bronze | 18872448 |
| | Suede | 18872452 |

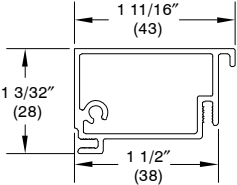
| <p>1 1/2" Flat Casing, A3069 200" (5080)</p>  | Color | Part No. |
|---|----------------|----------|
| | Stone White | 18816420 |
| | Bronze | 18816405 |
| | Pebble | 18816400 |
| | Brown | 18816410 |
| | Evergreen | 18816415 |
| | Wineberry | 18816440 |
| | Ebony | 18816425 |
| | Cashmere | 18816435 |
| | Coconut Cream | 18816430 |
| | Cadet Gray | 18816450 |
| | Cascade Blue | 18816445 |
| | Hampton Sage | 18816455 |
| | Sierra White | 18816460 |
| | Bright Silver | 18816465 |
| | Copper | 18816470 |
| | Clay | 18816490 |
| | Gunmetal | 18816480 |
| | Liberty Bronze | 18816475 |
| | Suede | 18816485 |

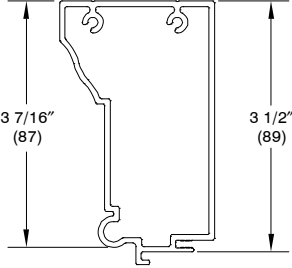
| <p>Columbus Casing, A1440 200" (5080)</p>  | Color | Part No. |
|--|----------------|----------|
| | Stone White | 18813925 |
| | Bronze | 18813915 |
| | Pebble | 18813910 |
| | Brown | 18813905 |
| | Evergreen | 18813920 |
| | Wineberry | 18813940 |
| | Ebony | 18813945 |
| | Cashmere | 18813950 |
| | Coconut Cream | 18813960 |
| | Cadet Gray | 18813965 |
| | Cascade Blue | 18813970 |
| | Hampton Sage | 18813975 |
| | Sierra White | 18813980 |
| | Bright Silver | 18813990 |
| | Copper | 18813985 |
| | Clay | 18872422 |
| | Gunmetal | 18872418 |
| | Liberty Bronze | 18872416 |
| | Suede | 18872420 |

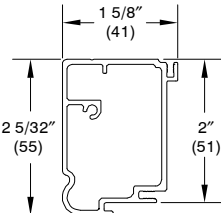
| | | |
|---|----------------|-----------------|
| <p>Grayson Casing, A1442 200" (5080)</p>  | Color | Part No. |
| | Stone White | 18815410 |
| | Bronze | 18815406 |
| | Pebble | 18815404 |
| | Brown | 18815402 |
| | Evergreen | 18815408 |
| | Wineberry | 18815416 |
| | Ebony | 18815418 |
| | Cashmere | 18815420 |
| | Coconut Cream | 18815426 |
| | Cadet Gray | 18815428 |
| | Cascade Blue | 18815430 |
| | Hampton Sage | 18815432 |
| | Sierra White | 18815434 |
| | Bright Silver | 18861208 |
| | Copper | 18861204 |
| | Clay | 18872438 |
| | Gunmetal | 18872434 |
| | Liberty Bronze | 18872432 |
| | Suede | 18872436 |

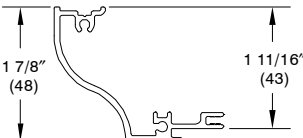
| | | |
|---|----------------|-----------------|
| <p>Thorton Casing, A1443 200" (5080)</p>  | Color | Part No. |
| | Stone White | 18815536 |
| | Bronze | 18815532 |
| | Pebble | 18815530 |
| | Brown | 18815528 |
| | Evergreen | 18815534 |
| | Wineberry | 18815542 |
| | Ebony | 18815544 |
| | Cashmere | 18815546 |
| | Coconut Cream | 18815552 |
| | Cadet Gray | 18815554 |
| | Cascade Blue | 18815556 |
| | Hampton Sage | 18815558 |
| | Sierra White | 18815560 |
| | Bright Silver | 18861692 |
| | Copper | 18861694 |
| | Clay | 18872446 |
| | Gunmetal | 18872442 |
| | Liberty Bronze | 18872440 |
| | Suede | 18872444 |

Thorton Enclosed Casing, A1909
 200" (5080)

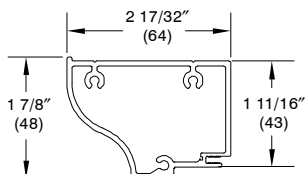

| Color | Part No. |
|----------------|----------|
| Stone White | 18815608 |
| Bronze | 18815610 |
| Pebble | 18815612 |
| Brown | 18815614 |
| Evergreen | 18815616 |
| Wineberry | 18815618 |
| Ebony | 18815620 |
| Cashmere | 18815622 |
| Coconut Cream | 18815624 |
| Cadet Gray | 18815626 |
| Cascade Blue | 18815628 |
| Hampton Sage | 18815630 |
| Sierra White | 18815632 |
| Bright Silver | 18815640 |
| Copper | 18815642 |
| Clay | 18815638 |
| Gunmetal | 18815636 |
| Liberty Bronze | 18815644 |
| Suede | 18815634 |

Ridgeland Casing, A1446
 200" (5080)

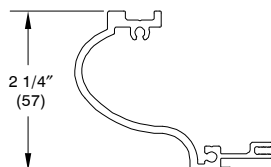

| Color | Part No. |
|----------------|----------|
| Stone White | 18815452 |
| Bronze | 18815448 |
| Pebble | 18815446 |
| Brown | 18815444 |
| Evergreen | 18815450 |
| Wineberry | 18815458 |
| Ebony | 18815460 |
| Cashmere | 18815462 |
| Coconut Cream | 18815468 |
| Cadet Gray | 18815470 |
| Cascade Blue | 18815472 |
| Hampton Sage | 18815474 |
| Sierra White | 18815476 |
| Bright Silver | 18861232 |
| Copper | 18861228 |
| Clay | 18872470 |
| Gunmetal | 18872466 |
| Liberty Bronze | 18872464 |
| Suede | 18872468 |

Ridgeland Enclosed Casing, A2881
 200" (5080)

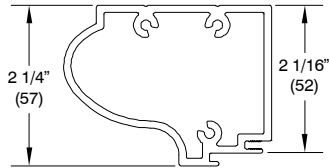

| Color | Part No. |
|----------------|----------|
| Stone White | 18815568 |
| Bronze | 18815570 |
| Pebble | 18815572 |
| Brown | 18815574 |
| Evergreen | 18815576 |
| Wineberry | 18815578 |
| Ebony | 18815580 |
| Cashmere | 18815582 |
| Coconut Cream | 18815584 |
| Cadet Gray | 18815586 |
| Cascade Blue | 18815588 |
| Hampton Sage | 18815590 |
| Sierra White | 18815592 |
| Bright Silver | 18815600 |
| Copper | 18815602 |
| Clay | 18815598 |
| Gunmetal | 18815596 |
| Liberty Bronze | 18815604 |
| Suede | 18815594 |

Stratton Casing, A1449
 200" (5080)

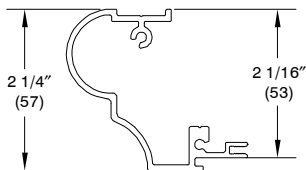

| Color | Part No. |
|----------------|----------|
| Stone White | 18814910 |
| Bronze | 18814906 |
| Pebble | 18814904 |
| Brown | 18814902 |
| Evergreen | 18814908 |
| Wineberry | 18814916 |
| Ebony | 18814918 |
| Cashmere | 18814920 |
| Coconut Cream | 18814926 |
| Cadet Gray | 18814928 |
| Cascade Blue | 18814930 |
| Hampton Sage | 18814932 |
| Sierra White | 18814934 |
| Bright Silver | 18861240 |
| Copper | 18861236 |
| Clay | 18872494 |
| Gunmetal | 18872490 |
| Liberty Bronze | 18872488 |
| Suede | 18872492 |

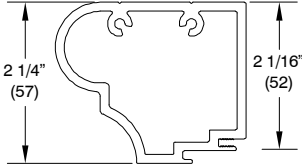
| | | |
|---|---------------------|------------------------|
| <p>Stratton Enclosed Casing, A2366 200" (5080)</p>  | <p>Color</p> | <p>Part No.</p> |
| | Stone White | 18815648 |
| | Bronze | 18815650 |
| | Pebble | 18815652 |
| | Brown | 18815654 |
| | Evergreen | 18815656 |
| | Wineberry | 18815658 |
| | Ebony | 18815660 |
| | Cashmere | 18815662 |
| | Coconut Cream | 18815664 |
| | Cadet Gray | 18815666 |
| | Cascade Blue | 18815668 |
| | Hampton Sage | 18815670 |
| | Sierra White | 18815672 |
| | Bright Silver | 18815680 |
| | Copper | 18815682 |
| | Clay | 18815678 |
| | Gunmetal | 18815676 |
| | Liberty Bronze | 18815684 |
| | Suede | 18815674 |

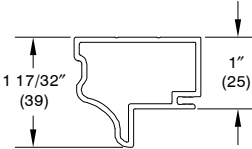
| | | |
|---|---------------------|------------------------|
| <p>Potter Trim Casing, A1445 200" (5080)</p>  | <p>Color</p> | <p>Part No.</p> |
| | Stone White | 18815494 |
| | Bronze | 18815490 |
| | Pebble | 18815488 |
| | Brown | 18815486 |
| | Evergreen | 18815492 |
| | Wineberry | 18815500 |
| | Ebony | 18815502 |
| | Cashmere | 18815504 |
| | Coconut Cream | 18815510 |
| | Cadet Gray | 18815512 |
| | Cascade Blue | 18815514 |
| | Hampton Sage | 18815516 |
| | Sierra White | 18815518 |
| | Bright Silver | 18861054 |
| | Copper | 18861052 |
| | Clay | 18872462 |
| | Gunmetal | 18872458 |
| | Liberty Bronze | 18872456 |
| | Suede | 18872460 |

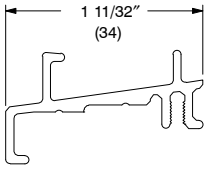
| <p>CBMC Subsill, A246 192" (4877)</p>  | Color | Part No. |
|--|----------------|-----------------|
| | Stone White | 18801540 |
| | Bronze | 18614999 |
| | Pebble | 18614899 |
| | Brown | 18614799 |
| | Evergreen | 18615099 |
| | Wineberry | 18801550 |
| | Ebony | 18801552 |
| | Cashmere | 19000150 |
| | Coconut Cream | 19003150 |
| | Cadet Gray | 19004150 |
| | Cascade Blue | 19005150 |
| | Hampton Sage | 19006150 |
| | Sierra White | 19007150 |
| | Bright Silver | 18861090 |
| | Copper | 18861088 |
| | Clay | 18872270 |
| | Gunmetal | 18872266 |
| | Liberty Bronze | 18872264 |
| | Suede | 18872268 |

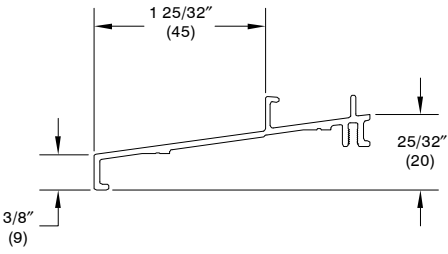
| <p>Subsill, A1450 200" (5080)</p>  | Color | Part No. |
|--|----------------|-----------------|
| | Stone White | 18815010 |
| | Bronze | 18815006 |
| | Pebble | 18815004 |
| | Brown | 18815002 |
| | Evergreen | 18815008 |
| | Wineberry | 18815016 |
| | Ebony | 18815018 |
| | Cashmere | 18815020 |
| | Coconut Cream | 18815026 |
| | Cadet Gray | 18815028 |
| | Cascade Blue | 18815030 |
| | Hampton Sage | 18815032 |
| | Sierra White | 18815034 |
| | Bright Silver | 18861642 |
| | Copper | 18861640 |
| | Clay | 18872510 |
| | Gunmetal | 18872506 |
| | Liberty Bronze | 18872504 |
| | Suede | 18872508 |

Simulated Thick Sill, A217
 200" (5080)

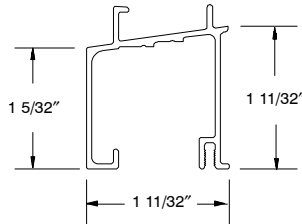

| Color | Part No. |
|----------------|----------|
| Stone White | 18801968 |
| Bronze | 18565399 |
| Pebble | 18565299 |
| Brown | 18565199 |
| Evergreen | 18565499 |
| Wineberry | 18801978 |
| Ebony | 18801972 |
| Cashmere | 19000316 |
| Coconut Cream | 19003316 |
| Cadet Gray | 19004316 |
| Cascade Blue | 19005316 |
| Hampton Sage | 19006316 |
| Sierra White | 19007316 |
| Bright Silver | 18861658 |
| Copper | 18861656 |
| Clay | 18872238 |
| Gunmetal | 18872234 |
| Liberty Bronze | 18872232 |
| Suede | 18872236 |

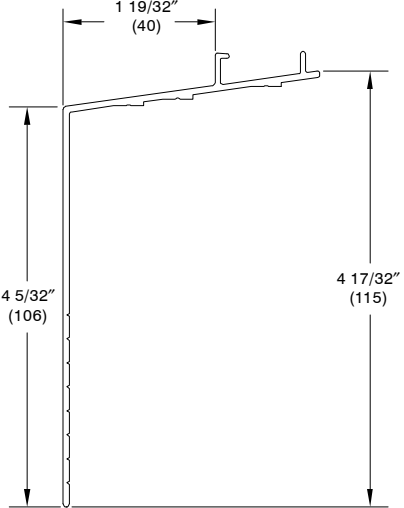
| <p>Subsill, A1451 200" (5080)</p>  | Color | Part No. |
|--|--------------|-----------------|
| | Stone White | 18815110 |
| Bronze | 18815106 | |
| Pebble | 18815104 | |
| Brown | 18815012 | |
| Evergreen | 18815108 | |
| Wineberry | 18815116 | |
| Ebony | 18815118 | |
| Cashmere | 18815120 | |
| Coconut Cream | 18815126 | |
| Cadet Gray | 18815128 | |
| Cascade Blue | 18815130 | |
| Hampton Sage | 18815132 | |
| Sierra White | 18115134 | |
| Bright Silver | 18861646 | |
| Copper | 18861644 | |
| Clay | 18872518 | |
| Gunmetal | 18872514 | |
| Liberty Bronze | 18872512 | |
| Suede | 18872516 | |

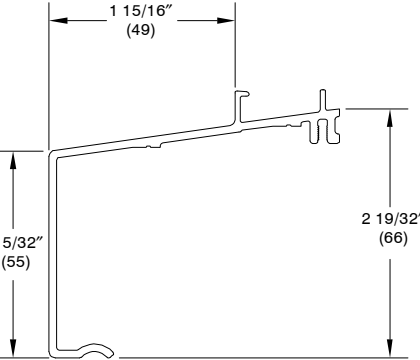
| <p>Subsill, A1452 200" (5080)</p>  | Color | Part No. |
|--|--------------|-----------------|
| | Stone White | 18815210 |
| Bronze | 18815206 | |
| Pebble | 18815204 | |
| Brown | 18815202 | |
| Evergreen | 18815208 | |
| Wineberry | 18815216 | |
| Ebony | 18815218 | |
| Cashmere | 18815220 | |
| Coconut Cream | 18815226 | |
| Cadet Gray | 18815228 | |
| Cascade Blue | 18815230 | |
| Hampton Sage | 18815232 | |
| Sierra White | 18815234 | |
| Bright Silver | 18861648 | |
| Copper | 18861650 | |
| Clay | 18872526 | |
| Gunmetal | 18872522 | |
| Liberty Bronze | 18872520 | |
| Suede | 18872524 | |

Subsill, A1453
 200" (5080)

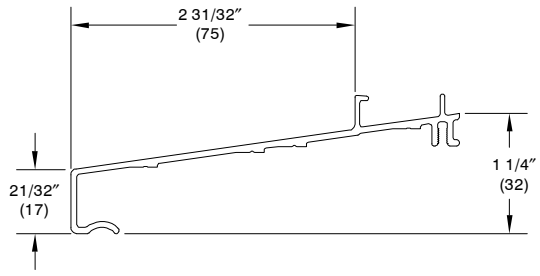

| Color | Part No. |
|----------------|----------|
| Stone White | 18815310 |
| Bronze | 18815306 |
| Pebble | 18815304 |
| Brown | 18815302 |
| Evergreen | 18815308 |
| Wineberry | 18815316 |
| Ebony | 18815318 |
| Cashmere | 18815320 |
| Coconut Cream | 18815326 |
| Cadet Gray | 18815328 |
| Cascade Blue | 18815330 |
| Hampton Sage | 18815332 |
| Sierra White | 18815334 |
| Bright Silver | 18861652 |
| Copper | 18861654 |
| Clay | 18872534 |
| Gunmetal | 18872530 |
| Liberty Bronze | 18872528 |
| Suede | 18872532 |

Exterior Frame Trim, A148
 A148 is only applied to the entire perimeter of an assembly when there are both vertical and horizontal space mulls or stud pockets. Otherwise only used on the end of space mulls or stud pockets.
 150" (3810)

Note: Must also use accessory kerf weather strip – frame

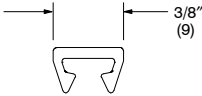

| Color | Part No. |
|----------------|----------|
| Stone White | 18801440 |
| Bronze | 15224830 |
| Pebble | 15224820 |
| Brown | 15224810 |
| Evergreen | 15224840 |
| Wineberry | 18801450 |
| Ebony | 18801452 |
| Cashmere | 19000138 |
| Coconut Cream | 19003138 |
| Cadet Gray | 19004138 |
| Cascade Blue | 19005138 |
| Hampton Sage | 19006138 |
| Sierra White | 19007138 |
| Bright Silver | 18861660 |
| Copper | 18861662 |
| Clay | 18872166 |
| Gunmetal | 18872162 |
| Liberty Bronze | 18872160 |
| Suede | 18872164 |

| <p>Mull Clip, A104 150" (3810)</p>  | Color | Part No. |
|---|----------------|-----------------|
| | Stone White | 18800840 |
| | Bronze | 18600499 |
| | Pebble | 18600399 |
| | Brown | 18600299 |
| | Evergreen | 18600599 |
| | Wineberry | 18800850 |
| | Ebony | 18800852 |
| | Cashmere | 19000102 |
| | Coconut Cream | 19003102 |
| | Cadet Gray | 19004102 |
| | Cascade Blue | 19005102 |
| | Hampton Sage | 19006102 |
| | Sierra White | 19007102 |
| | Bright Silver | 18861122 |
| | Copper | 18861120 |
| | Clay | 18872014 |
| | Gunmetal | 18872010 |
| | Liberty Bronze | 18872008 |
| | Suede | 18872012 |

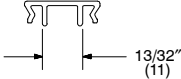
| <p>3/8" Mull Cover, A117 150" (3810)</p> <p>Note: Must also use accessory kerf weather strip – frame</p>  | Color | Part No. |
|---|----------------|-----------------|
| | Stone White | 18800980 |
| | Bronze | 18601430 |
| | Pebble | 18601420 |
| | Brown | 18601410 |
| | Evergreen | 18601440 |
| | Wineberry | 18800990 |
| | Ebony | 18800992 |
| | Cashmere | 19000122 |
| | Coconut Cream | 19003122 |
| | Cadet Gray | 19004122 |
| | Cascade Blue | 19005122 |
| | Hampton Sage | 19006122 |
| | Sierra White | 19007122 |
| | Bright Silver | 18861146 |
| | Copper | 18861144 |
| | Clay | 18872086 |
| | Gunmetal | 18872082 |
| | Liberty Bronze | 18872080 |
| | Suede | 18872084 |

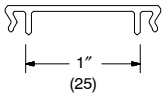
| <p>1" Mull Cover, A111 150" (3810)</p> <p>Note: Must also use accessory kerf weather strip – frame</p>  | Color | Part No. |
|--|----------------|----------|
| | Stone White | 18800880 |
| | Bronze | 18600630 |
| | Pebble | 18600620 |
| | Brown | 18600610 |
| | Evergreen | 18600640 |
| | Wineberry | 18800890 |
| | Ebony | 18800892 |
| | Cashmere | 19000112 |
| | Coconut Cream | 19003112 |
| | Cadet Gray | 19004112 |
| | Cascade Blue | 19005112 |
| | Hampton Sage | 19006112 |
| | Sierra White | 19007112 |
| | Bright Silver | 18861134 |
| | Copper | 18861132 |
| | Clay | 18872046 |
| | Gunmetal | 18872042 |
| | Liberty Bronze | 18872040 |
| | Suede | 18872044 |

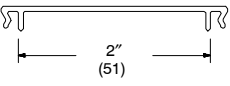
| <p>2" Mull Cover, A112 150" (3810)</p> <p>Note: Must also use accessory kerf weather strip – frame</p>  | Color | Part No. |
|--|----------------|----------|
| | Stone White | 18800900 |
| | Bronze | 18600680 |
| | Pebble | 18600670 |
| | Brown | 18600660 |
| | Evergreen | 18600690 |
| | Wineberry | 18800910 |
| | Ebony | 18800912 |
| | Cashmere | 19000114 |
| | Coconut Cream | 19003114 |
| | Cadet Gray | 19004114 |
| | Cascade Blue | 19005114 |
| | Hampton Sage | 19006114 |
| | Sierra White | 19007114 |
| | Bright Silver | 18861138 |
| | Copper | 18861136 |
| | Clay | 18872054 |
| | Gunmetal | 18872050 |
| | Liberty Bronze | 18872048 |
| | Suede | 18872052 |

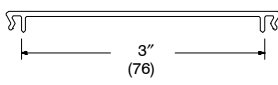
| <p>3" Mull Cover, A113 150" (3810)</p> <p>Note: Must also use accessory kerf weather strip – frame</p>  | Color | Part No. |
|--|----------------|----------|
| | Stone White | 18800920 |
| | Bronze | 18600730 |
| | Pebble | 18600720 |
| | Brown | 18600710 |
| | Evergreen | 18600740 |
| | Wineberry | 18800930 |
| | Ebony | 18800932 |
| | Cashmere | 19000116 |
| | Coconut Cream | 19003116 |
| | Cadet Gray | 19004116 |
| | Cascade Blue | 19005116 |
| | Hampton Sage | 19006116 |
| | Sierra White | 19007116 |
| | Bright Silver | 18861142 |
| | Copper | 18861140 |
| | Clay | 18872062 |
| | Gunmetal | 18872058 |
| | Liberty Bronze | 18872056 |
| | Suede | 18872060 |

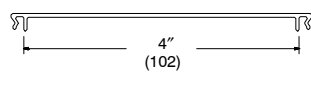
| <p>4" Mull Cover, A114 150" (3810)</p> <p>Note: Must also use accessory kerf weather strip – frame</p>  | Color | Part No. |
|--|----------------|----------|
| | Stone White | 18800940 |
| | Bronze | 18600780 |
| | Pebble | 18600770 |
| | Brown | 18600760 |
| | Evergreen | 18600790 |
| | Wineberry | 18800950 |
| | Ebony | 18800952 |
| | Cashmere | 19000118 |
| | Coconut Cream | 19003118 |
| | Cadet Gray | 19004118 |
| | Cascade Blue | 19005118 |
| | Hampton Sage | 19006118 |
| | Sierra White | 19007118 |
| | Bright Silver | 18861150 |
| | Copper | 18861148 |
| | Clay | 18872070 |
| | Gunmetal | 18872066 |
| | Liberty Bronze | 18872064 |
| | Suede | 18872068 |

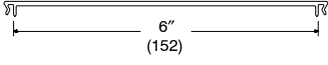
| <p>6" Mull Cover, A116 150" (3810)</p> <p>Note: Must also use accessory kerf weather strip – frame</p>  | Color | Part No. |
|--|----------------|-----------------|
| | Stone White | 18800960 |
| | Bronze | 18600830 |
| | Pebble | 18600820 |
| | Brown | 18600810 |
| | Evergreen | 18600835 |
| | Wineberry | 18800970 |
| | Ebony | 18800972 |
| | Cashmere | 19000120 |
| | Coconut Cream | 19003120 |
| | Cadet Gray | 19004120 |
| | Cascade Blue | 19005120 |
| | Hampton Sage | 19006120 |
| | Sierra White | 19007120 |
| | Bright Silver | 18861154 |
| | Copper | 18861152 |
| | Clay | 18872078 |
| | Gunmetal | 18872074 |
| | Liberty Bronze | 18872072 |
| | Suede | 18872076 |

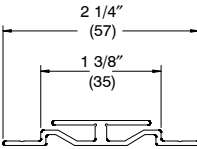
| <p>1" Mull Expander, A118 With off-set mounting tabs 150" (3810)</p>  | Color | Part No. |
|---|----------------|-----------------|
| | Stone White | 18801000 |
| | Bronze | 18601630 |
| | Pebble | 18601620 |
| | Brown | 18601610 |
| | Evergreen | 18601640 |
| | Wineberry | 18601410 |
| | Ebony | 18801012 |
| | Cashmere | 19000124 |
| | Coconut Cream | 19003124 |
| | Cadet Gray | 19004124 |
| | Cascade Blue | 19005124 |
| | Hampton Sage | 19006124 |
| | Sierra White | 19007124 |
| | Bright Silver | 18861254 |
| | Copper | 18861252 |
| | Clay | 18872094 |
| | Gunmetal | 18872090 |
| | Liberty Bronze | 18872088 |
| | Suede | 18872092 |

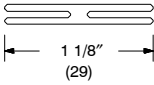
| <p>1" Mull Expander, A107 150" (3810)</p>  | Color | Part No. |
|--|----------------|----------|
| | Stone White | 18801400 |
| | Bronze | 18601330 |
| | Pebble | 18601320 |
| | Brown | 18601310 |
| | Evergreen | 18601340 |
| | Wineberry | 18801410 |
| | Ebony | 18801412 |
| | Cashmere | 19000104 |
| | Coconut Cream | 19003104 |
| | Cadet Gray | 19004104 |
| | Cascade Blue | 19005104 |
| | Hampton Sage | 19006104 |
| | Sierra White | 19007104 |
| | Bright Silver | 18861250 |
| | Copper | 18861248 |
| | Clay | 18874024 |
| | Gunmetal | 18874020 |
| | Liberty Bronze | 18874018 |
| | Suede | 18874022 |

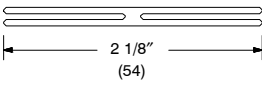
| <p>2" Mull Expander, A108 150" (3810)</p>  | Color | Part No. |
|--|----------------|----------|
| | Stone White | 18601395 |
| | Bronze | 18601380 |
| | Pebble | 18601370 |
| | Brown | 18601360 |
| | Evergreen | 18601390 |
| | Wineberry | 18601397 |
| | Ebony | 18601393 |
| | Cashmere | 19000106 |
| | Coconut Cream | 19003106 |
| | Cadet Gray | 19004106 |
| | Cascade Blue | 19005106 |
| | Hampton Sage | 19006106 |
| | Sierra White | 19007106 |
| | Bright Silver | 18861262 |
| | Copper | 18861260 |
| | Clay | 18872022 |
| | Gunmetal | 18872018 |
| | Liberty Bronze | 18872016 |
| | Suede | 18872020 |

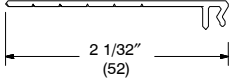
| <p>2" Frame Expander, A110 150" (3810)</p> <p>Note: Must also use accessory kerf weather strip – frame</p>  | Color | Part No. |
|--|----------------|----------|
| | Stone White | 18601099 |
| | Bronze | 18601080 |
| | Pebble | 18601070 |
| | Brown | 18601060 |
| | Evergreen | 18601090 |
| | Wineberry | 18601101 |
| | Ebony | 18801432 |
| | Cashmere | 19000110 |
| | Coconut Cream | 19003110 |
| | Cadet Gray | 19004110 |
| | Cascade Blue | 19005110 |
| | Hampton Sage | 19006110 |
| | Sierra White | 19007110 |
| | Bright Silver | 18861258 |
| | Copper | 18861256 |
| | Clay | 18872038 |
| | Gunmetal | 18872034 |
| | Liberty Bronze | 18872032 |
| | Suede | 18872036 |

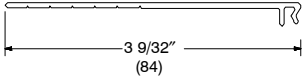
| <p>3" Frame Expander, A109 150" (3810)</p> <p>Note: Must also use accessory kerf weather strip – frame</p>  | Color | Part No. |
|--|----------------|----------|
| | Stone White | 18800860 |
| | Bronze | 18601030 |
| | Pebble | 18601020 |
| | Brown | 18601010 |
| | Evergreen | 18601040 |
| | Wineberry | 18800870 |
| | Ebony | 18800872 |
| | Cashmere | 19000108 |
| | Coconut Cream | 19003108 |
| | Cadet Gray | 19004108 |
| | Cascade Blue | 19005108 |
| | Hampton Sage | 19006108 |
| | Sierra White | 19007108 |
| | Bright Silver | 18861266 |
| | Copper | 18861264 |
| | Clay | 18872030 |
| | Gunmetal | 18872026 |
| | Liberty Bronze | 18872024 |
| | Suede | 18872028 |

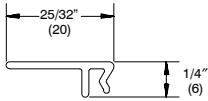
| | | |
|--|----------------|-----------------|
| <p>3/4" Frame Expander, A1012 Ultimate Double Hung Insert Disc LA PRE 8/27/18 150" (3810)</p> <p>Note: Must also use accessory kerf weather strip – frame</p>  | Color | Part No. |
| | Stone White | 18578599 |
| | Bronze | 18578399 |
| | Pebble | 18578299 |
| | Brown | 18578199 |
| | Evergreen | 18578499 |
| | Wineberry | 18586199 |
| | Ebony | 18586399 |
| | Cashmere | 19000716 |
| | Coconut Cream | 19003716 |
| | Cadet Gray | 19004716 |
| | Cascade Blue | 19005716 |
| | Hampton Sage | 19006716 |
| | Sierra White | 19007716 |
| | Bright Silver | 18861270 |
| | Copper | 18861268 |
| | Clay | 18872334 |
| | Gunmetal | 18872330 |
| | Liberty Bronze | 18872328 |
| | Suede | 18872332 |

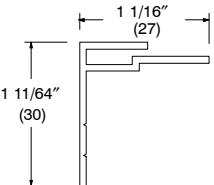
| | | |
|---|----------------|-----------------|
| <p>90 Degree Frame Expander, A120 150" (3810)</p>  | Color | Part No. |
| | Stone White | 18801013 |
| | Bronze | 18601230 |
| | Pebble | 18601220 |
| | Brown | 18601210 |
| | Evergreen | 18601240 |
| | Wineberry | 18801018 |
| | Ebony | 18801019 |
| | Cashmere | 19000128 |
| | Coconut Cream | 19003128 |
| | Cadet Gray | 19004128 |
| | Cascade Blue | 19005218 |
| | Hampton Sage | 19006128 |
| | Sierra White | 19007128 |
| | Bright Silver | 18861274 |
| | Copper | 18861272 |
| | Clay | 18872102 |
| | Gunmetal | 18872098 |
| | Liberty Bronze | 18872096 |
| | Suede | 18872100 |

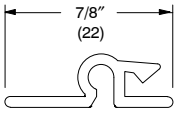
| <p>Extender, Jamb Extension, A126 150" (3810)</p> <p>Note: Must also use accessory kerf weather strip – frame</p>  | Color | Part No. |
|---|----------------|----------|
| | Stone White | 18714099 |
| | Bronze | 18601280 |
| | Pebble | 18601270 |
| | Brown | 18601260 |
| | Evergreen | 18601290 |
| | Bright Silver | 18861282 |
| | Copper | 18861280 |
| | Clay | 18872134 |
| | Gunmetal | 18872130 |
| | Liberty Bronze | 18872128 |
| | Suede | 18872132 |

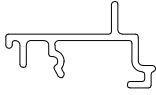
| <p>Jamb Filler, A1388 CUDHM 162" (4115)</p>  | Color | Part No. |
|--|----------------|----------|
| | Stone White | 18627025 |
| | Bronze | 18627015 |
| | Pebble | 18627010 |
| | Brown | 18627005 |
| | Evergreen | 18627020 |
| | Wineberry | 18627030 |
| | Ebony | 18627035 |
| | Cashmere | 18627070 |
| | Coconut Cream | 18627075 |
| | Cadet Gray | 18627080 |
| | Cascade Blue | 18627085 |
| | Hampton Sage | 18627090 |
| | Sierra White | 18627095 |
| | Bright Silver | 18627045 |
| | Copper | 18627040 |
| | Clay | 18627065 |
| | Gunmetal | 18627055 |
| | Liberty Bronze | 18627050 |
| | Suede | 18627060 |

| <p>Jamb Filler, Single Hung, A1413 CUSHM 150" (3810)</p>  | Color | Part No. |
|---|----------------|----------|
| | Stone White | 18628598 |
| | Bronze | 18628398 |
| | Pebble | 18628298 |
| | Brown | 18628198 |
| | Evergreen | 18628498 |
| | Wineberry | 18628898 |
| | Ebony | 18628998 |
| | Cashmere | 19000656 |
| | Coconut Cream | 19003656 |
| | Cadet Gray | 19004656 |
| | Cascade Blue | 19005656 |
| | Hampton Sage | 19006656 |
| | Sierra White | 19007656 |
| | Bright Silver | 18861330 |
| | Copper | 18861328 |
| | Clay | 18874032 |
| | Gunmetal | 18874028 |
| | Liberty Bronze | 18874026 |
| | Suede | 18874030 |

| | |
|---|-------------|
| | Clad |
| Jamb Filler, Ultimate Double Hung Picture DISC LA PRE 6/29/15 | A199 |

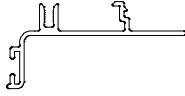

A199 – Jamb
Filler, CUDHP

Subsill End Cap for A1453
 Right Hand or Left Hand. Each part number contains one cap.
 *Note: Copper uses Brown part number

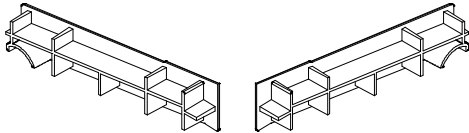

| Color | RH Part No. | LH Part No. |
|----------------|-------------|-------------|
| Stone White | 18812310 | 18812311 |
| Bronze | 18812306 | 18812307 |
| Pebble | 18812304 | 18812305 |
| Brown | 18812302 | 18812303 |
| Evergreen | 18812308 | 18812309 |
| Wineberry | 18812316 | 18812317 |
| Ebony | 18812318 | 18812319 |
| Cashmere | 18812320 | 18812321 |
| Coconut Cream | 18812326 | 18812327 |
| Cadet Gray | 18812328 | 18812329 |
| Cascade Blue | 18812330 | 18812331 |
| Hampton Sage | 18812332 | 18812333 |
| Sierra White | 18812334 | 18812335 |
| Bright Silver | 18812322 | 18812323 |
| Copper | 18812302 | 18812306 |
| Clay | 18812348 | 18812350 |
| Gunmetal | 18812344 | 18812346 |
| Liberty Bronze | 18812340 | 18812342 |
| Suede | 18812352 | 18812354 |

Subsill End Cap for A217
 Right Hand or Left Hand. Each part number contains one cap.
 *Note: MCP uses Brown part number

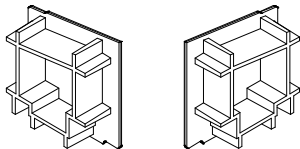

| Color | RH Part No. | LH Part No. |
|----------------|-------------|-------------|
| Stone White | 18812110 | 18812111 |
| Bronze | 18812106 | 18812107 |
| Pebble | 18812104 | 18812105 |
| Brown | 18812102 | 18812103 |
| Evergreen | 18812108 | 18812109 |
| Wineberry | 18812116 | 18812117 |
| Ebony | 18812118 | 18812119 |
| Cashmere | 18812120 | 18812121 |
| Coconut Cream | 18812126 | 18812127 |
| Cadet Gray | 18812128 | 18812129 |
| Cascade Blue | 18812130 | 18812131 |
| Hampton Sage | 18812132 | 18812133 |
| Sierra White | 18812134 | 18812135 |
| Bright Silver | 18812122 | 18812123 |
| Copper | 18812102 | 18812103 |
| Clay | 18812144 | 18812145 |
| Gunmetal | 18812142 | 18812143 |
| Liberty Bronze | 18812140 | 18812141 |
| Suede | 18812146 | 18812147 |

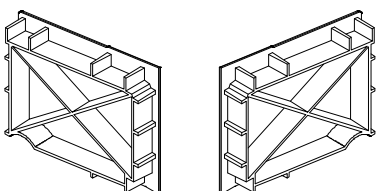
| <p>Subsill End Cap for A1452 Right Hand or Left Hand. Each part number contains one cap. *Note: MCP uses BN part number</p>  | Color | RH Part No. | LH Part No. |
|--|----------------|-------------|-------------|
| | Stone White | 18812210 | 18812211 |
| | Bronze | 18812206 | 18812207 |
| | Pebble | 18812204 | 18812205 |
| | Brown | 18812202 | 18812203 |
| | Evergreen | 18812208 | 18812209 |
| | Wineberry | 18812216 | 18812217 |
| | Ebony | 18812218 | 18812219 |
| | Cashmere | 18812220 | 18812221 |
| | Coconut Cream | 18812226 | 18812227 |
| | Cadet Gray | 18812228 | 18812229 |
| | Cascade Blue | 18812230 | 18812231 |
| | Hampton Sage | 18812232 | 18812233 |
| | Sierra White | 18812234 | 18812235 |
| | Bright Silver | 18812222 | 18812223 |
| | Copper | 18812202 | 18812203 |
| | Clay | 18812244 | 18812245 |
| | Gunmetal | 18812242 | 18812243 |
| | Liberty Bronze | 18812240 | 18812241 |
| | Suede | 18812246 | 18812247 |

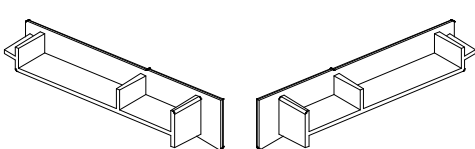
| <p>Subsill End Cap for A1450 Right Hand or Left Hand. Each part number contains one cap. *Note: MCP uses BN part number</p>  | Color | RH Part No. | LH Part No. |
|--|----------------|-------------|-------------|
| | Stone White | 18812410 | 18812411 |
| | Bronze | 18812406 | 18812407 |
| | Pebble | 18812404 | 18812405 |
| | Brown | 18812402 | 18812403 |
| | Evergreen | 18812408 | 18812409 |
| | Wineberry | 18812416 | 18812417 |
| | Ebony | 18812418 | 18812419 |
| | Cashmere | 18812420 | 18812421 |
| | Coconut Cream | 18812426 | 18812427 |
| | Cadet Gray | 18812428 | 18812429 |
| | Cascade Blue | 18812430 | 18812431 |
| | Hampton Sage | 18812432 | 18812433 |
| | Sierra White | 18812434 | 18812435 |
| | Bright Silver | 18812422 | 18812423 |
| | Copper | 18812402 | 18812403 |
| | Clay | 18812444 | 18812445 |
| | Gunmetal | 18812442 | 18812443 |
| | Liberty Bronze | 18812440 | 18812441 |
| | Suede | 18812446 | 18812447 |

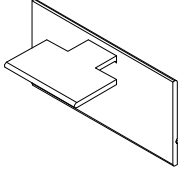
| <p>Clad Flat Casing End Cap, A247 1 5/32" (30) Used with A3069 Flat Casing</p>  | Color | Part No. |
|---|----------------|-----------------|
| | Stone White | 18816720 |
| | Bronze | 18816710 |
| | Pebble | 18816705 |
| | Brown | 18816700 |
| | Evergreen | 18816715 |
| | Wineberry | 18816725 |
| | Ebony | 18816730 |
| | Cashmere | 18816755 |
| | Coconut Cream | 18816765 |
| | Cadet Gray | 18816770 |
| | Cascade Blue | 18816775 |
| | Hampton Sage | 18816780 |
| | Sierra White | 18816785 |
| | Bright Silver | 18816760 |
| | Copper | 18816790 |
| | Clay | 18816750 |
| | Gunmetal | 18816740 |
| | Liberty Bronze | 18816735 |
| | Suede | 18816745 |

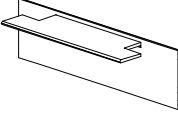
| <p>Clad Flat Casing End Cap, for A247 3 11/64" (81) Used with A2754 Flat Casing</p>  | Color | Part No. |
|--|----------------|-----------------|
| | Stone White | 18723099 |
| | Bronze | 18615403 |
| | Pebble | 18615303 |
| | Brown | 18615203 |
| | Evergreen | 18615503 |
| | Wineberry | 18723599 |
| | Ebony | 18723699 |
| | Cashmere | 19000153 |
| | Coconut Cream | 19003153 |
| | Cadet Gray | 19004153 |
| | Cascade Blue | 19005153 |
| | Hampton Sage | 19006153 |
| | Sierra White | 19007153 |
| | Bright Silver | 19002161 |
| | Copper | 19008164 |
| | Clay | 18873358 |
| | Gunmetal | 18873350 |
| | Liberty Bronze | 18873346 |
| | Suede | 18873354 |

Clad Flat Casing End Cap, A247
 4 43/64" (119)
 Used with A1444 Flat Casing

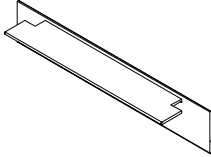

| Color | Part No. |
|----------------|----------|
| Stone White | 18723098 |
| Bronze | 18615404 |
| Pebble | 18615304 |
| Brown | 18615204 |
| Evergreen | 18615504 |
| Wineberry | 18723598 |
| Ebony | 18723698 |
| Cashmere | 19000157 |
| Coconut Cream | 19003157 |
| Cadet Gray | 19004157 |
| Cascade Blue | 19005157 |
| Hampton Sage | 19006157 |
| Sierra White | 19007157 |
| Bright Silver | 19002165 |
| Copper | 19008167 |
| Clay | 18873360 |
| Gunmetal | 18873352 |
| Liberty Bronze | 18873348 |
| Suede | 18873356 |

Subsill Lineal Cap, A1462
 For A217 Subsill
 200" (5080)

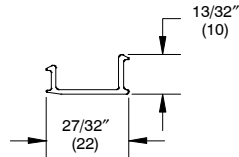

| Color | Part No. |
|----------------|----------|
| Stone White | 18816210 |
| Bronze | 18816206 |
| Pebble | 18816204 |
| Brown | 18816202 |
| Evergreen | 18816208 |
| Wineberry | 18816216 |
| Ebony | 18816218 |
| Cashmere | 18816220 |
| Coconut Cream | 18816226 |
| Cadet Gray | 18816228 |
| Cascade Blue | 18816230 |
| Hampton Sage | 18816232 |
| Sierra White | 18816234 |
| Bright Silver | 18861070 |
| Copper | 18861068 |
| Clay | 18872558 |
| Gunmetal | 18872554 |
| Liberty Bronze | 18872552 |
| Suede | 18872556 |

Subsill Lineal Cap, A1460
 For A1452 Subsill
 200" (5080)

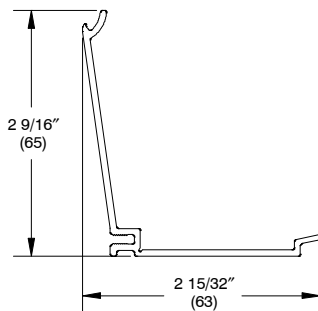

| Color | Part No. |
|----------------|----------|
| Stone White | 18816010 |
| Bronze | 18816006 |
| Pebble | 18816004 |
| Brown | 18816002 |
| Evergreen | 18816008 |
| Wineberry | 18816016 |
| Ebony | 18816018 |
| Cashmere | 18816020 |
| Coconut Cream | 18816026 |
| Cadet Gray | 18816028 |
| Cascade Blue | 18816030 |
| Hampton Sage | 18816032 |
| Sierra White | 18816034 |
| Bright Silver | 18861066 |
| Copper | 18861064 |
| Clay | 18872550 |
| Gunmetal | 18872546 |
| Liberty Bronze | 18872544 |
| Suede | 18872548 |

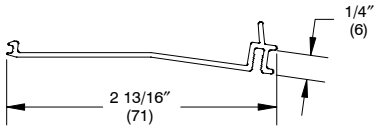
| <p>Subsill Lineal Cap, A1463 For A1450 Subsill 200" (5080)</p>  | Color | Part No. |
|---|----------------|-----------------|
| | Stone White | 18816310 |
| | Bronze | 18816306 |
| | Pebble | 18816304 |
| | Brown | 18816302 |
| | Evergreen | 18816308 |
| | Wineberry | 18816316 |
| | Ebony | 18816318 |
| | Cashmere | 18816320 |
| | Coconut Cream | 18816326 |
| | Cadet Gray | 18816328 |
| | Cascade Blue | 18816330 |
| | Hampton Sage | 18816332 |
| | Sierra White | 18816334 |
| | Bright Silver | 18861074 |
| | Copper | 18861072 |
| | Clay | 18872566 |
| | Gunmetal | 18872562 |
| | Liberty Bronze | 18872560 |
| | Suede | 18872564 |

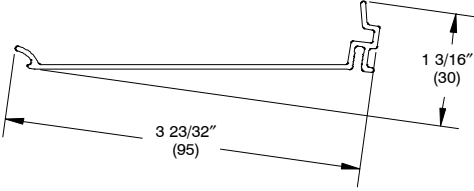
| <p>Subsill Lineal Cap, A1458 For A1453 Subsill 200" (5080)</p>  | Color | Part No. |
|---|----------------|-----------------|
| | Stone White | 18815810 |
| | Bronze | 18815806 |
| | Pebble | 18815804 |
| | Brown | 18815802 |
| | Evergreen | 18815808 |
| | Wineberry | 18815816 |
| | Ebony | 18815818 |
| | Cashmere | 18815820 |
| | Coconut Cream | 18815826 |
| | Cadet Gray | 18815828 |
| | Cascade Blue | 18815830 |
| | Hampton Sage | 18815832 |
| | Sierra White | 18815834 |
| | Bright Silver | 18861062 |
| | Copper | 18861060 |
| | Clay | 18872542 |
| | Gunmetal | 18872538 |
| | Liberty Bronze | 18872536 |
| | Suede | 18872540 |

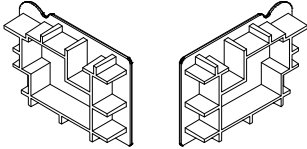
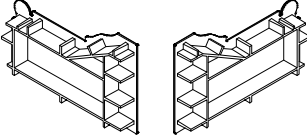
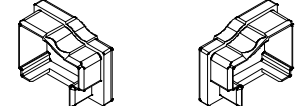
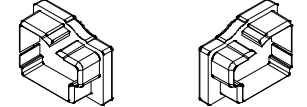
| ILLUSTRATION NOT TO SCALE | DESCRIPTION | COLOR | RH PART NO. | LH PART NO. |
|---|--|--------|----------------|----------------|
|  | <p>Casing End Cap for A1442, Grayson <i>Right Hand or Left Hand.</i> <i>Each part number contains one cap.</i></p> | Beige | 10500370 | 10500371 |
|  | <p>Casing End Cap for A1440, Columbus <i>Right Hand or Left Hand.</i> <i>Each part number contains one cap.</i></p> | Beige | 10500372 | 10500373 |
|  | <p>CBMC End Plug For Doors</p> | Beige | 16218005 | 16218006 |
|  | <p>End Plug for Radius BMC For Doors</p> | Beige | 10500273 | 10500274 |
| | | Bronze | 16218007 | 16218008 |
| | | | 10500275 | 10500276 |

ENERGY PANEL AND COMBINATION PARTS

Energy panels and combination units are attached with the current style turn buttons. Discontinued black turn buttons have been replaced by brown

When ordering energy panels parts specify quantity, part number, color and description.

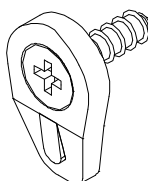
| ILLUSTRATION <i>NOT TO SCALE</i> | DESCRIPTION |
|---|---|
|  | Turn Button All turn buttons include a #8x3/4" SS full thread screw |

| Color | Each | Pkg of 8 | Pkg of 50 | Pkg of 100 |
|-------------|----------|----------|-----------|------------|
| Stone White | 11869294 | 11869454 | 11869314 | 11869320 |
| Clear | 11869309 | 11869455 | 11869315 | 11869321 |
| Pebble | 11869292 | 11869452 | 11869312 | 11869318 |
| Bronze | 11869291 | 11869451 | 11869311 | 11869317 |
| Brown | 11869293 | 11869453 | 11869313 | 11869319 |

NOTE: Energy panels for Ultimate Double/Single Hung, Ultimate Double/Single Hung Magnum and Ultimate Glider are attached with metal turn buttons. When ordering replacement parts specify size, color of surround and glass type.

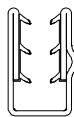
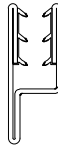
| ILLUSTRATION <i>NOT TO SCALE</i> | DESCRIPTION | COLOR | PART NO. |
|---|--|-----------------------|----------------------|
|  | Turn Button with #4 " x 3/4 " screw (11800334) | metal | 02580411 |
|  | Energy Panel Surround, Aluminum Profile A155 Stile and bottom rail For single strength glass – 3/32" (2) Available in 150" (3810) length | Stone White Bronze | 15246299 15243399 |
| | Energy Panel Surround, Aluminum Profile A157 Stile and bottom rail For double strength glass – 1/8" (3) Available in 150" (3810) length | Stone White Bronze | 15246199 15244299 |
|  | Energy Panel Surround, Aluminum Profile A156 Top rail For single strength glass – 3/32" (2) Available in 150" (3810) length | Stone White Bronze | 15246099 15243799 |
| | Energy Panel Surround, Aluminum Profile A158 Top rail For double strength glass – 1/8" (3) Available in 150" (3810) length | Stone White Bronze | 15246399 15244799 |

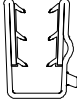
| ILLUSTRATION <i>NOT TO SCALE</i> | DESCRIPTION | COLOR | PART NO. |
|---|--|-----------------------|----------------------|
|  | Energy Panel Surround, Aluminum Profile A152 For 3/16" glass Available in 150" (3810) length | Stone White Bronze | 15242260 15242250 |
|  | Energy Panel Surround, Aluminum Profile A159 Top rail For Single strength glass – 3/32" (2.5) Available in 150" (3810) length | Stone White Bronze | 15246499 15245299 |
| | Energy Panel Surround, Aluminum Profile A162 Top rail For Double strength glass – 1/8" (3.0) Available in 150" (3810) length | Stone White Bronze | 15245999 15245799 |

| | |
|--------------------|---------------------|
| Jamb Filler, CUDHP | Clad A199 |
|--------------------|---------------------|

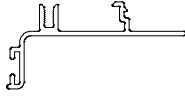

A199 – Jamb
Filler, CUDHP