

2 1/4" SWINGING FRENCH DOORS

Table of Contents

	PAGE
History	2
Part Identification – Wood 2 1/4" Outswing French Door	3
Part Identification – Wood 2 1/4" Outswing French Door Stationary	4
Part Identification – Clad 2 1/4" Outswing French Door	5
Part Identification – Wood 2 1/4" Inswing French Door	6
Part Identification – Wood 2 1/4" Inswing French Door Stationary	7
Part Identification – Clad 2 1/4" Inswing French Door	8
Part Identification – Wood 2 1/4" Outswing Arch Top French Door	9
Part Identification – Clad 2 1/4" Outswing Arch Top French Door	10
Part Identification – Wood 2 1/4" Inswing Arch Top French Door	11
Part Identification – Clad 2 1/4" Inswing Arch Top French Door	12
Replacement Parts	13
Panel Replacement	23
Weather Strip	24
Replacement Aluminum and Wood Parts	26
Parts for Lock Status Sensor	28
Obsolete Parts	29
 Screens – See Door Screen Chapter	

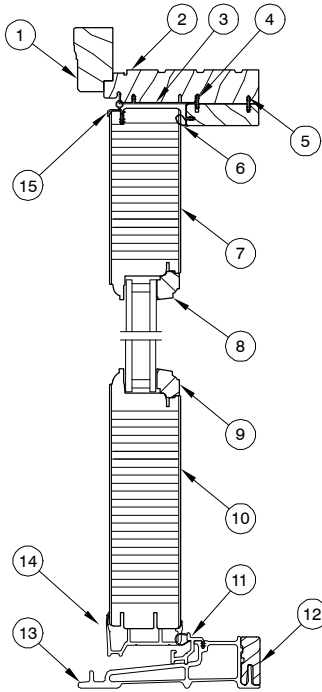
ATTENTION:

- Specification and technical data are subject to change without notice.
- Numbers listed in parentheses () are metric equivalents in millimeters rounded to the nearest whole number.

PRODUCED	UNIT TYPE	FEATURES OR CHANGES	STATUS
2005	IZ3 2 1/4" Panel Doors	5/31/2005 2 1/4" Panel StormPlus IZ3 doors introduced. Units feature multi-point lock, LVL stiles and rails, and 4 1/2" x 4 1/2" ball bearing hinges.	Present
2005	IZ4 2 1/4" Panel Doors	9/06/2005 Introduced 2 1/4" Panel door for StormPlus IZ4.	Present
2006	2 1/4" French Doors	11/20/2006 Introduced the 2 1/4" door as a standard residential product.	Present
2007	2 1/4" French Doors	2/20/07 Introduced raised and flat panels as a standard option for Marvin French Doors and Commercial Doors.	Present
2008	Clad 2 1/4" French Doors	7/28/2008 Mixed grain Douglas fir is now a standard option.	Present
2009	All	3/23/2009 Added LoE ³ -366™ as a standard option for all products. Added Cedro Macho as a standard option for all clad products.	Present
2009	2 1/4" Outswing French Doors and 2 1/4" Outswing Arch Top French Doors	3/30/2009 Implemented design changes to the 2 1/4" Outswing. Changes include new panel sweep, dust blocks, IZ3/IZ4 wood bead and shoot bolt reinforcement.	Present
2010	All Doors	2/22/2010 Added Dark Bronze hardware finish to doors.	Present
2011	All Doors	4/25/2011 Added LoE-180™ as a standard option for all products. White painted interior finish option introduced for all products.	Present
2012	All Doors	7/30/2012 Adjustable Hinge became standard. 10/29/2012 Interior Square Sticking/Glazing Bead option introduced. 12/17/2012 Introduced Clear Interior Finish option on all products.	Present
2013	All Doors	4/29/2013 – Introduced interior stain options. Stain colors are Wheat, Honey, Leather, Hazelnut, Cabernet and Espresso.	Present
	2 1/4" Inswing and Outswing French Doors	12/16/2013 – Interior Shades option introduced.	
2014	All Doors and 2 1/4" Inswing and Outswing French Doors	2/24/2014– Introduced two Pearlescent clad colors – Bright Silver and Copper. Discontinued two clad colors – Sherwood Green and Cobalt Blue. Removed screen information and added new chapter for screen to manual. 4/28/2014 – Added the Contemporary Panel and Contemporary Handle options.	Present
2014	All Doors and 2 1/4" Inswing and Outswing French Doors	6/23/2014 – Added PVD color options for the Contemporary Handle; Oil Rubbed Bronze PVD and Satin Nickel PVD are now available.	Present
2014	All Doors and 2 1/4" Inswing and Outswing French Doors	8/25/2014 Panel drip (A2408) will now match clad color. Screws will match standard clad colors. For Custom Color Clad, screws will be stainless steel.	Present
2015	2 1/4" Outswing French Doors and 2 1/4" Outswing Arch Top French Doors	6/06/2015 Replace the current sweep profiles for the Outswing doors. V1713 and V1657 are replaced with V2416 and V2427. The A2408 Panel Drip is no longer needed with this new sweep design.	Present
2016	All	10/31/2016 Obsolescence of the wood species Cedro Macho for all products.	Present
2017	All Clad 2 1/4" Inswing and Outswing, 2 1/4" Inswing and Outswing Arch Top French Doors	12/18/2017 – Added availability of Lock Status Sensor.	Present

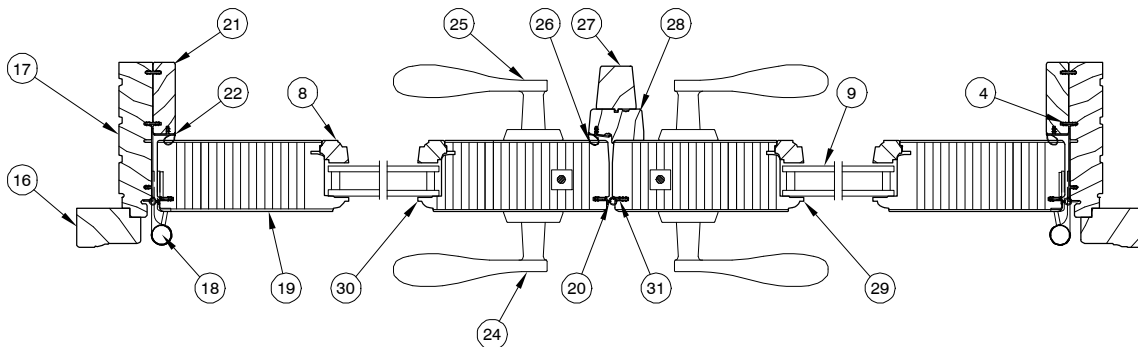
**Wood 2 1/4"
 Outswing French Door**

Also available with IZ3 and IZ4 glazing.



**Head Jamb
 and Sill**

1. Head Jamb Brick Mould Casing
2. Head Jamb
3. Head Jamb Weather Strip
4. Connecting Barb
5. Head Jamb Stop
6. Head Jamb Stop Weather Strip
7. Top Rail
8. Glazing Bead
9. Insulating Glass
10. Bottom Rail
11. Sill Weather Strip
12. Sill Liner
13. Sill
14. Sweep
15. Panel Cover Weather Strip
16. Jamb Brick Mould Casing
17. Jamb
18. Adjustable Hinge
19. Stile
20. Stile Weather Strip
21. Jamb Stop
22. Jamb Stop Weather Strip
23. Jamb Weather Strip
24. Exterior Handle
25. Interior Handle
26. Astragal Weather Strip
27. Astragal
28. Astragal Base
29. Inactive Panel Locking Stile
30. Active Panel Locking Stile
31. Inactive Panel Weather Strip

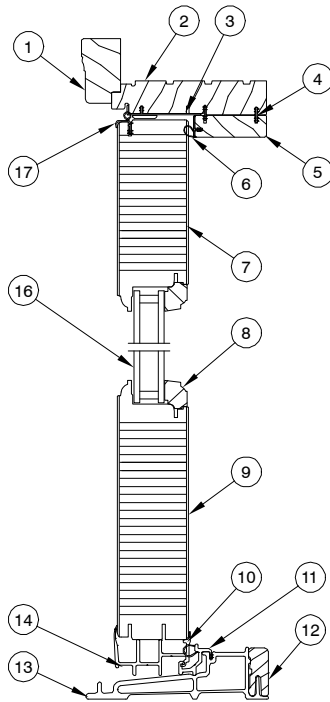


Jamb XX-R

NOTE: Not to scale; specifications subject to change without notice.

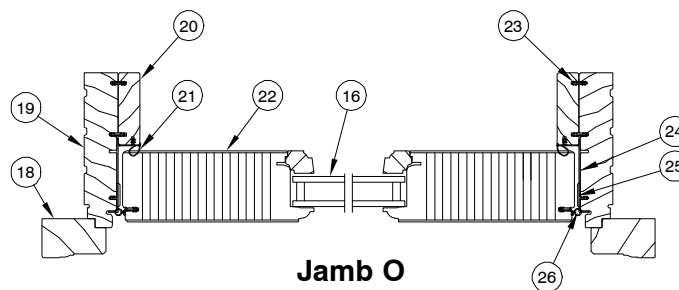
**Wood 2 1/4"
 Outswing French Door
 Stationary**

Also available with IZ3 and IZ4 glazing.



**Head Jamb
 and Sill**

1. Head Jamb Brick Mould Casing
2. Head Jamb
3. Head Jamb Weather Strip
4. Connecting Barb
5. Head Jamb Stop
6. Head Jamb Stop Weather Strip
7. Top Rail
8. Glazing Bead
9. Bottom Rail
10. Sweep
11. Sill Weather Strip
12. Sill Liner
13. Sill
14. Stationary Sweep Filler
15. Panel Drip
16. Insulating Glass
17. Panel Cover Weather Strip
18. Jamb Brick Mould Casing
19. Jamb
20. Jamb Stop
21. Jamb Weather Strip
22. Stationary Stile
23. Connecting Barb
24. Frame Weather Strip
25. Spacer Tack
26. Stile Weather Strip[

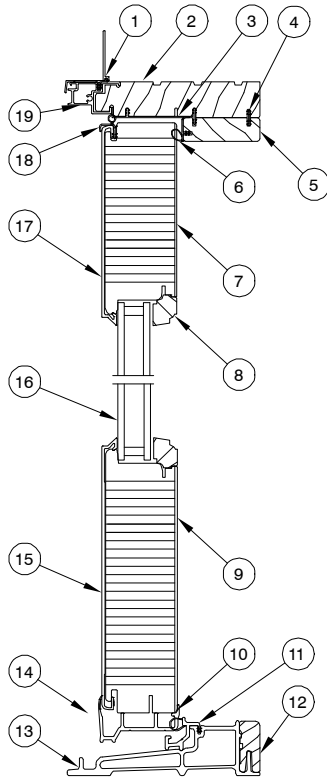


Jamb O

NOTE: Not to scale; specifications subject to change without notice.

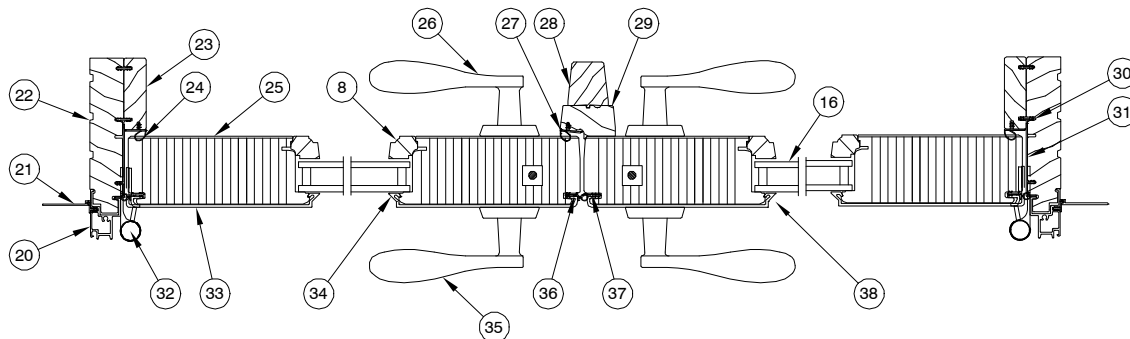
**Clad 2 1/4"
 Outswing French Door**

Also available with IZ3 and IZ4 glazing.



**Head Jamb
 and Sill**

1. Nailing Fin/Drip Cap
2. Head Jamb
3. Frame Weather Strip
4. Connecting Barb
5. Head Jamb Stop
6. Head Jamb Stop Weather Strip
7. Top Rail
8. Glazing Bead
9. Bottom Rail
10. Sweep
11. Sill Weather Strip
12. Sill Liner
13. Sill
14. Sweep
15. Bottom Rail Cladding
16. Insulating Glass
17. Top Rail Cladding
18. Panel Cover Weather Strip
19. Head Jamb Cladding
20. Jamb Cladding
21. Nailing Fin
22. Jamb
23. Jamb Stop
24. Jamb Stop Weather Strip
25. Stile
26. Interior Handle
27. Astragal Weather Strip
28. Astragal
29. Astragal Base
30. Connecting Barb
31. Frame Weather Strip
32. Adjustable Hinge
33. Stile Cladding
34. Active Panel Locking Stile
35. Exterior Handle

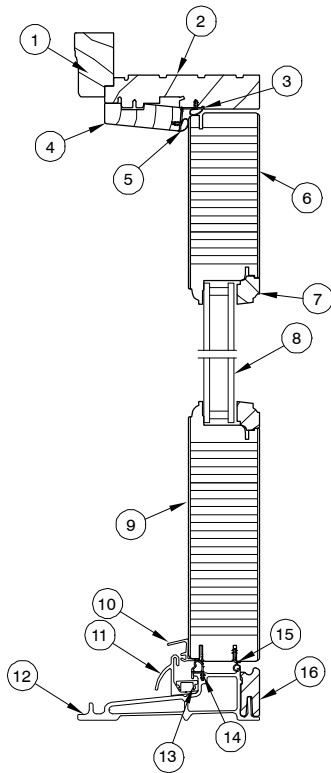


Jamb XX-R

NOTE: Not to scale; specifications subject to change without notice.

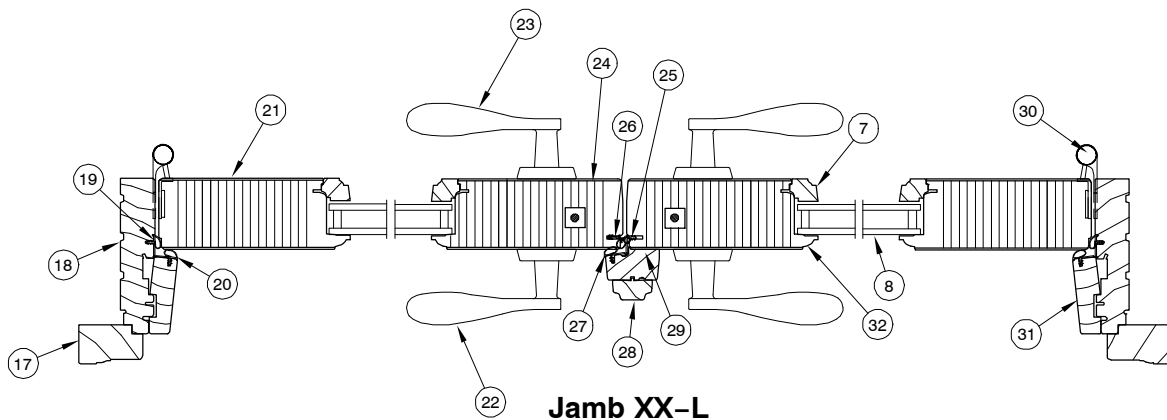
**Wood 2 1/4"
 Inswing French Door**

Also available with IZ3 glazing.



**Head Jamb
 and Sill**

1. Head Jamb Brick Mould Casing
2. Head Jamb
3. Head Jamb Weather Strip
4. Head Jamb Stop
5. Head Jamb Stop Weather Strip
6. Top Rail
7. Glazing Bead
8. Insulated Glass
9. Bottom Rail
10. Panel Drip
11. Hydro Optimizer
12. Sill
13. Hydro Optimizer Reinforcement
14. Sill Weather Strip
15. Stile Weather Strip
16. Sill Liner
17. Brick Mould Casing
18. Jamb
19. Jamb Weather Strip
20. Jamb Stop Weather Strip
21. Stile
22. Exterior Handle
23. Interior Handle
24. Active Panel Locking Stile
25. Mull Base Stile Weather Strip
26. Stile Weather Strip
27. Astragal Weather Strip
28. Astragal
29. Astragal Base
30. Ball Bearing Hinge
31. Side Jamb Parting Stop
32. Inactive Panel Locking Stile

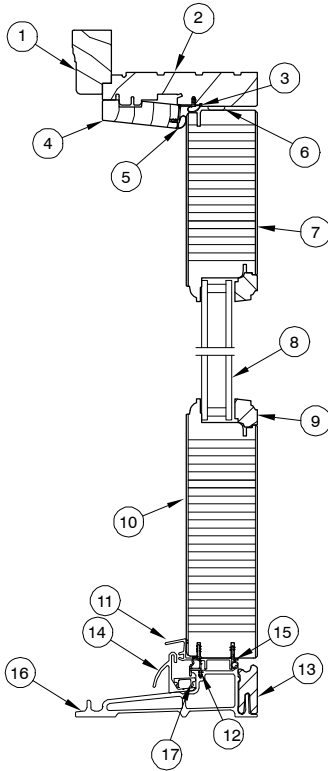


Jamb XX-L

NOTE: Not to scale; specifications subject to change without notice.

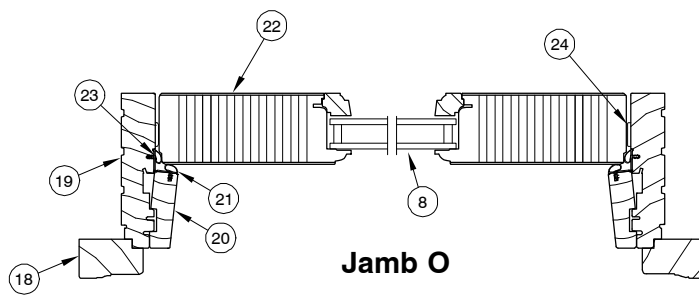
**Wood 2 1/4"
 Inswing French Door
 Stationary**

Also available with IZ3 glazing.



**Head Jamb
 and Sill**

1. Head Jamb Brick Mould Casing
2. Head Jamb
3. Head Jamb Weather Strip
4. Head Jamb Parting Stop
5. Head Jamb Stop Weather Strip
6. Header Spacer Tack
7. Top Rail
8. Insulating Glass
9. Glazing Bead
10. Bottom Rail
11. Panel Drip/Leveling Block
12. Sill Weather Strip
13. Sill Liner
14. Hydro-Optimizer
15. Bottom Rail Weather Strip
16. Sill
17. Hydro-optimizer Reinforcement
18. Side Brick Mould Casing
19. Side Jamb
20. Side Jamb Parting Stop
21. Side Jamb Parting Stop Weather Strip
22. Stationary Stile
23. Side Jamb Weather Strip
24. Stationary Panel Spacer Tack

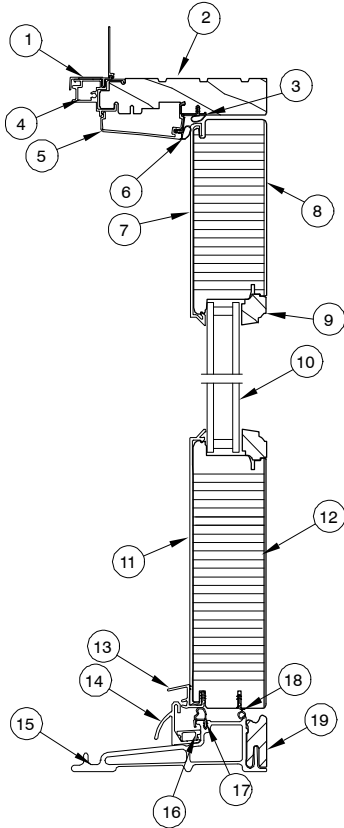


Jamb O

NOTE: Not to scale; specifications subject to change without notice.

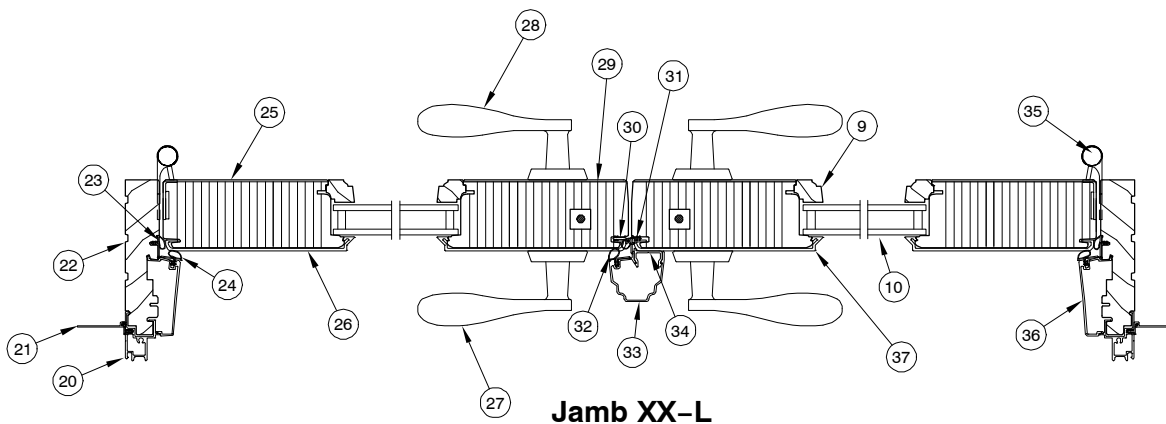
**Clad 2 1/4"
 Inswing French Door**

Also available with IZ3 glazing.



**Head Jamb
 and Sill**

1. Nailing Fin/Drip Cap
2. Head Jamb
3. Head Jamb Weather Strip
4. Head Jamb Cladding
5. Head Jamb Stop
6. Head Jamb Stop Weather Strip
7. Top Rail Cladding
8. Top Rail
9. Glazing Bead
10. Insulating Glass
11. Bottom Rail Cladding
12. Bottom Rail
13. Panel Drip
14. Hydro-Optimizer
15. Sill
16. Hydro-Optimizer Reinforcement
17. Sill Weather Strip
18. Stile Weather Strip
19. Sill Liner
20. Jamb Cladding
21. Nailing Fin
22. Jamb
23. Jamb Weather Strip
24. Jamb Stop Weather Strip
25. Stile
26. Stile Cladding
27. Exterior Handle
28. Interior Handle
29. Active Panel Locking Stile
30. Stile Weather Strip
31. Mull Base Stile Weather Strip
32. Astragal Weather Strip
33. Astragal
34. Astragal Base
35. Adjustable Hinge
36. Side Jamb Parting Stop
37. Inactive Panel Locking Stile

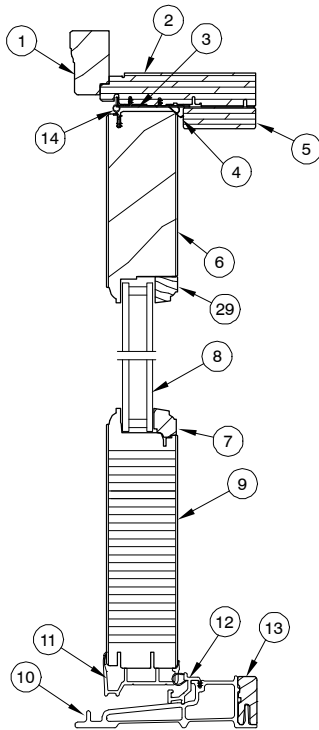


Jamb XX-L

NOTE: Not to scale; specifications subject to change without notice.

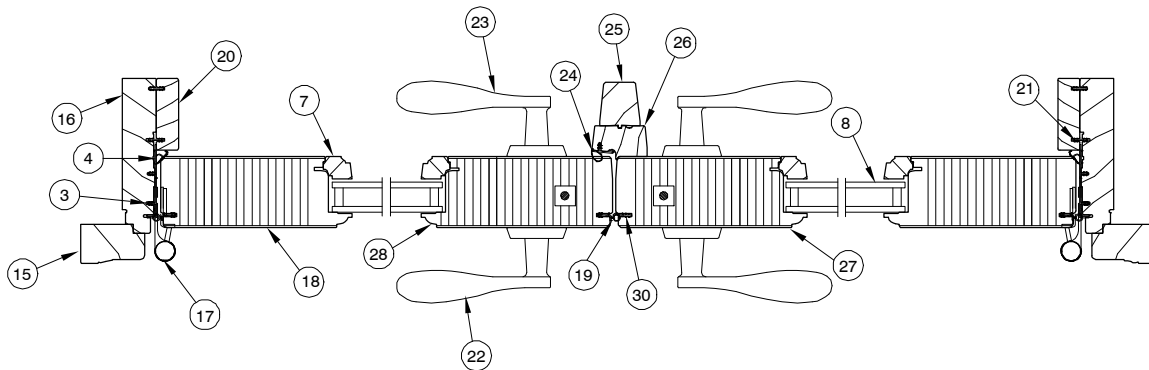
**Wood 2 1/4"
 Outswing Arch Top French Door**

Also available with IZ3 and IZ4 glazing.



1. Head Jamb Brick Mould Casing
2. Head Jamb
3. Frame Weather Strip
4. Bulb Weather Strip
5. Head Jamb Stop
6. Top Rail
7. Glazing Bead
8. Insulating Glass
9. Bottom Rail
10. Sill
11. Sweep
12. Sill Weather Strip
13. Sill Liner
14. Stile Weather Strip
15. Jamb Brick Mould Casing
16. Jamb
17. Adjustable Hinge
18. Stile
19. Stile Weather Strip
20. Jamb Stop
21. Connecting Barb
22. Exterior Handle
23. Interior Handle
24. Astragal Weather Strip
25. Astragal
26. Astragal Base
27. Inactive Panel Locking Stile
28. Active Panel Locking Stile
29. Radiused Glazing Bead
30. Inactive Panel Weather Strip

**Head Jamb
 and Sill**

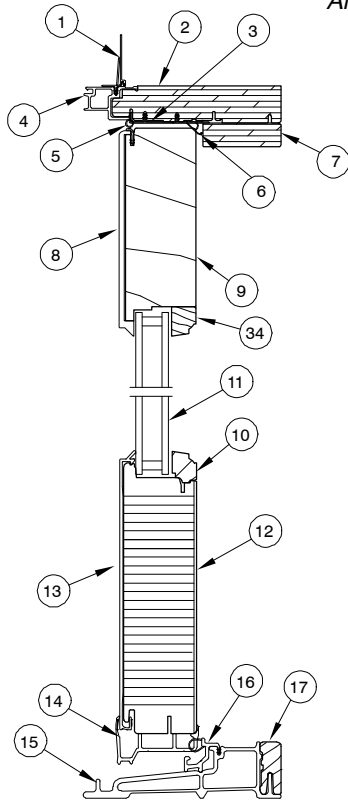


**Jamb XX-R RT2
 For RT6 part identification, see page 3.**

NOTE: Not to scale; specifications subject to change without notice.

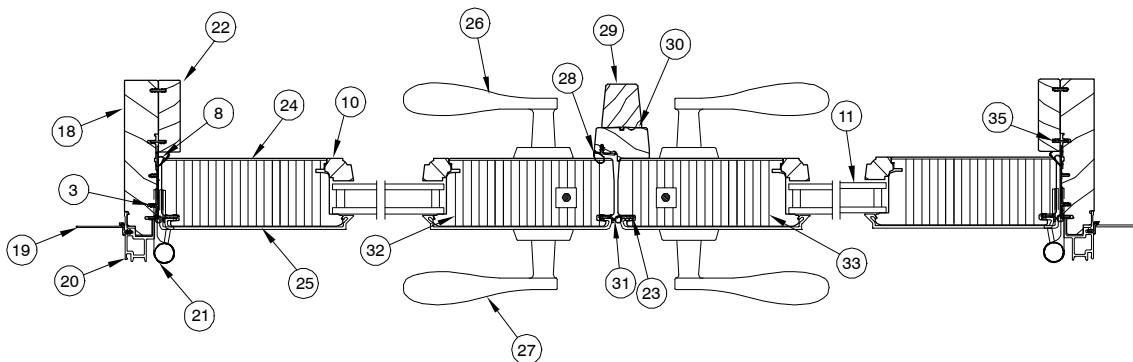
**Clad 2 1/4"
 Outswing Arch Top French Door**

Also available with IZ3 and IZ4 glazing.



**Head Jamb
 and Sill**

1. Nailing Fin/Drip Cap
2. Head Jamb
3. Frame Weather Strip
4. Head Jamb Cladding
5. Stile Weather Strip
6. Bulb Weather Strip
7. Head Jamb Stop
8. Top Rail Cladding
9. Top Rail
10. Glazing Bead
11. Insulated Glass
12. Bottom Rail
13. Bottom Rail Cladding
14. Sweep
15. Sill
16. Sill Weather Strip
17. Sill Liner
18. Jamb
19. Nailing Fin
20. Jamb Cladding
21. Adjustable Hinge
22. Jamb Stop
23. Inactive Panel Weather Strip
24. Stile
25. Stile Cladding
26. Interior Handle
27. Exterior Handle
28. Astragal Weather Strip
29. Astragal
30. Astragal Base
31. Stile Weather Strip
32. Active Panel Locking Stile
33. Inactive Panel Locking Stile
34. RADIUS Glazing Bead
35. Connecting Barb

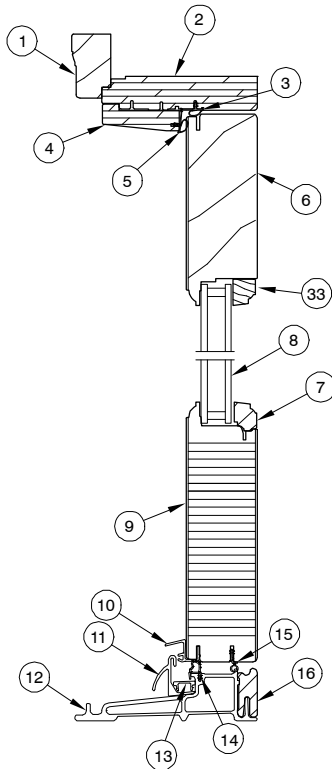


**Jamb XX-R RT2
 For RT6 part identification, see page 5**

NOTE: Not to scale; specifications subject to change without notice.

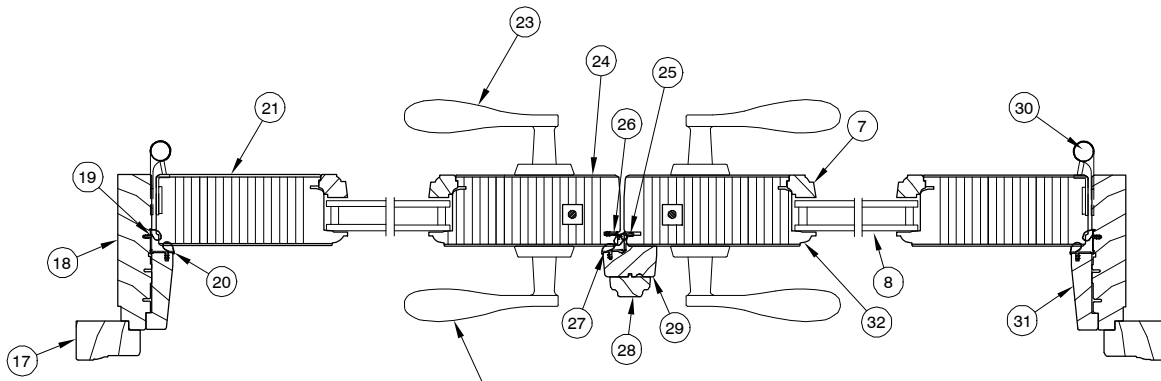
**Wood 2 1/4"
 Inswing Arch Top French Door**

Also available with IZ3 glazing.



1. Head Jamb Brick Mould Casing
2. Head Jamb
3. Head Jamb Weather Strip
4. Head Jamb Stop
5. Head Jamb Stop Weather Strip
6. Top Rail
7. Glazing Bead
8. Insulating Glass
9. Bottom Rail
10. Panel Drip
11. Hydro-Optimizer
12. Sill
13. Hydro-Optimizer Reinforcement
14. Sill Weather Strip
15. Stile Weather Strip
16. Sill Liner

**Head Jamb
 and Sill**



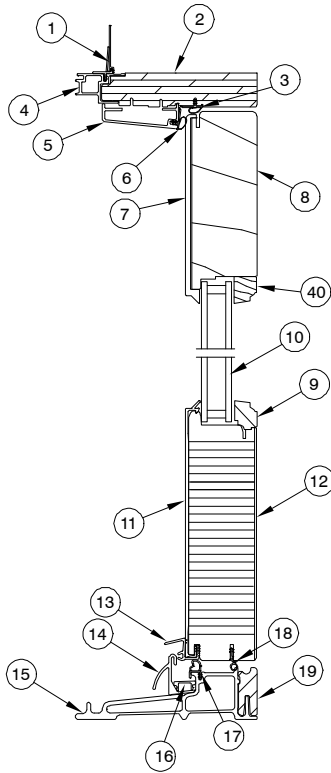
Jamb XX-L RT2

For RT6 part identification, see page 6

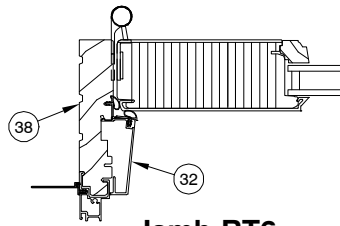
NOTE: Not to scale; specifications subject to change without notice.

Clad 2 1/4"
Inswing Arch Top French Door

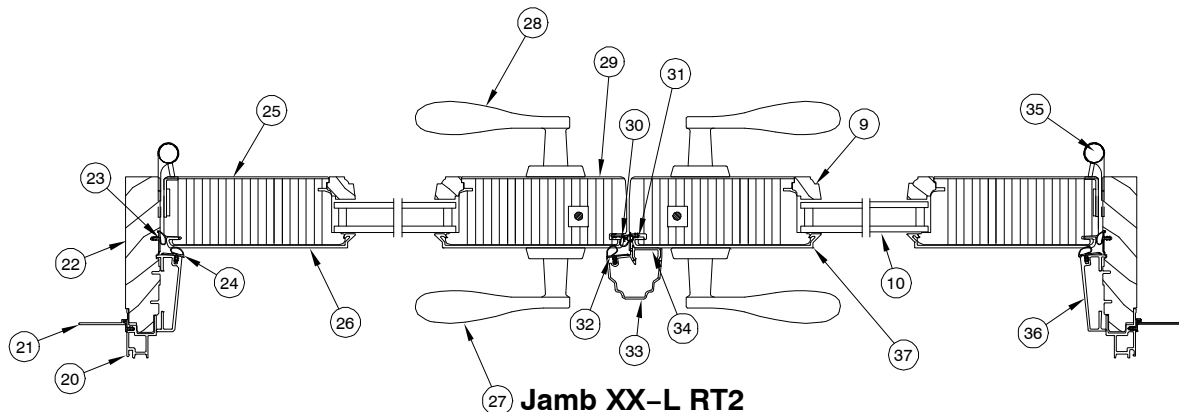
Also available with IZ3 glazing.



**Head Jamb
 and Sill**



Jamb RT6



Jamb XX-L RT2


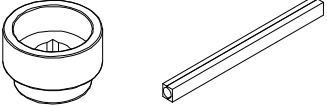

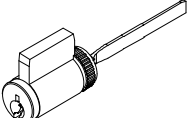

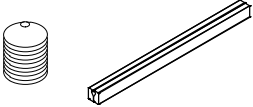

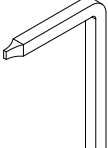
1. Nailing Fin/Drip Cap
2. Head Jamb
3. Head Jamb Weather Strip
4. Head Jamb Cladding
5. Head Jamb Stop
6. Head Jamb Stop Weather Strip
7. Top Rail Cladding
8. Top Rail
9. Glazing Bead
10. Insulating Glass
11. Bottom Rail Cladding
12. Bottom Rail
13. Panel Drip
14. Hydro-Optimizer
15. Sill
16. Hydro-Optimizer Reinforcement
17. Sill Weather Strip
18. Stile Weather Strip
19. Sill Liner
20. Jamb Cladding
21. Nailing Fin
22. Jamb - RT2
23. Jamb Weather Strip
24. Jamb Stop Weather Strip
25. Stile
26. Stile Cladding
27. Exterior Handle
28. Interior Handle
29. Active Panel Locking Stile
30. Stile Weather Strip
31. Mull Base Stile Weather Strip
32. Astragal Weather Strip
33. Astragal
34. Astragal Base
35. Adjustable Hinge
36. Side Jamb Parting Stop - RT2
37. Inactive Panel Locking Stile
38. Jamb RT6
39. Side Jamb Parting Stop - RT6
40. Radiused Glazing Bead

NOTE: Not to scale; specifications subject to change without notice.

When ordering replacement 2 1/4" Panel Door parts specify:

1. type of unit;
2. part number;
3. description.

ILLUSTRATION NOT TO SCALE	DESCRIPTION	COLOR	PART NO.
<p>Interior</p> <p>Exterior</p>	<p>Handle Assembly, Active Panel Includes:</p> <ul style="list-style-type: none"> 1 - Interior lever (A) with spindle, escutcheon plate and hardware 1 - Exterior lever (B) with escutcheon plate and hardware 1 - Thumb turn (C) with hardware 1 - Keyed cylinder (D) with housing and hardware 1 - Exterior escutcheon plate gasket (E) 1 - Exterior escutcheon plate (F) 1 - Two piece spindle (G) 2 - #10-32 x 2 5/8" Phillips oval head machine screws (H) 1 - Interior escutcheon plate (I) 2 - Keys 	<p>Satin Taupe Antique Brass Satin Chrome White Oil Rubbed Bronze Oil Rubbed Bronze PVD Brass PVD Satin Nickel PVD Dark Bronze Matte Black</p>	<p>21448114 21448116 21448112 21448119 21448111 21448118 21448160 21448110 21448120 21448131</p>
<p>Interior</p> <p>Exterior</p>	<p>Handle Assembly, Inactive Includes:</p> <ul style="list-style-type: none"> 1 - Interior lever (A) with spindle, escutcheon plate and hardware 1 - Exterior lever (B) with escutcheon plate and hardware 1 - Exterior escutcheon plate gasket (C) 1 - Exterior escutcheon plate (D) 1 - Two piece spindle (E) 2 - #10-32 x 2 5/8" Phillips oval head machine screws (F) 1 - Interior escutcheon plate (G) 	<p>Satin Taupe Antique Brass Satin Chrome White Oil Rubbed Bronze Oil Rubbed Bronze PVD Brass PVD Satin Nickel PVD Dark Bronze Matte Black</p>	<p>21448151 21448147 21448153 21448150 21448154 21448145 21448161 21448133 21448162 21448163</p>

ILLUSTRATION NOT TO SCALE	DESCRIPTION	COLOR	PART NO.
	Lug seals		00142046
	2 1/4" Swinging Handle Set Kit – Interior Shades <i>Includes:</i> 1 – 3/4" extension handle 1 – Spindle, lever handle, 2 pc. assembly 1 – Installation instruction	Satin Taupe White Brass PVD Antique Brass Oil Rubbed Bronze Oil Rubbed Bronze PVD Satin Chrome Satin Nickel PVD Polished Chrome Dark Bronze Matte Black	18900659 18900660 18900661 18900662 18900663 18900664 18900665 18900666 18900668 18900667 18900689
	#10–32 x 2 5/8" Phillips ovalhead machine screws (2 1/4" Door)	Satin Taupe Antique Brass Satin Chrome White Oil Rubbed Bronze Oil Rubbed Bronze PVD Brass PVD Satin Nickel PVD Dark Bronze Matte Black	11800156 11800150 11800151 11800157 11800153 11800159 11800155 11800154 11800169 11800179
	Key Cylinder, Lock (Schlage "C" keyway) For service replacement only. <i>NOTE: For Keyed Alike orders, use program C87P2.</i> <i>BS, ORBZ PVD, TP, WH, AB=Brass Face</i> <i>All other Marvin finishes=Chrome Face</i>	Brass Chrome	10830212 10830209
	Spindle, Two Piece Kit (Ashland) (2 1/4" Door) <i>Includes:</i> 1 – 2 piece spindle 5.061 2 – Set screws		18900393
	Spindle Kit (Truth) <i>For ORBZ handle sets produced after March 2009.</i> <i>Includes:</i> 1 – 2 piece spindle, 4.725" 2 – Set screws	Oil Rubbed Bronze	02100941
	Lever Bushing, Swinging Handle Set – Traditional	Clear Gray Gold Natural Black	02062201 10148448 10148447 02062202 10148020
	Construction Handle		10830451

PARTS – CONTEMPORARY HANDLE

When ordering replacement 2 1/4" Panel Door parts specify:

1. type of unit;
2. part number;
3. description.

ILLUSTRATION NOT TO SCALE	DESCRIPTION	COLOR	PART NO.
	<p>Handle Assembly, Active Panel Includes:</p> <ul style="list-style-type: none"> 1 - Interior lever (A) with 10148414 spindle, escutcheon plate and hardware 1 - Exterior lever (B) with escutcheon plate and hardware 1 - Thumb turn (C) with hardware 1 - Keyed cylinder (D) with housing and hardware 1 - Exterior escutcheon plate gasket (E) 1 - Exterior escutcheon plate (F) 1 - Two piece spindle (G) 2 - M5 x 65mm Phillips ovalhead machine screws (H) 1 - Interior escutcheon plate (I) 1 - Thumb turn washer (J) 1 - Thumb turn push nut (K) 2 - Keys 	<p>Satin Nickel PVD Oil Rubbed Bronze PVD Dark Bronze Matte Black</p>	<p>21448122 21448123 21448124 21448130</p>
	<p>Handle Assembly, Inactive Includes:</p> <ul style="list-style-type: none"> 1 - Interior lever (A) with 00142006 spindle, escutcheon plate and hardware 1 - Exterior lever (B) with escutcheon plate and hardware 1 - Exterior escutcheon plate gasket (C) 1 - Exterior escutcheon plate (D) 1 - Two piece spindle (E) 2 - M5 x 65mm Phillips oval head machine screws (F) 1 - Interior escutcheon plate (G) 	<p>Satin Nickel PVD Oil Rubbed Bronze PVD Dark Bronze Matte Black</p>	<p>21448126 21448127 21448128 21448129</p>

PARTS – CONTEMPORARY HANDLE


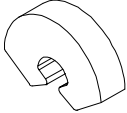

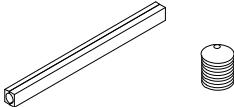
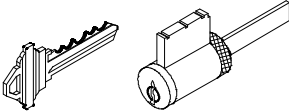

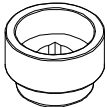
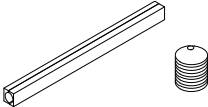
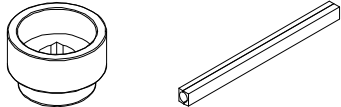

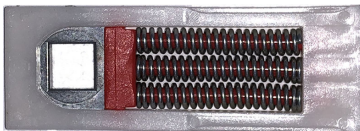
ILLUSTRATION NOT TO SCALE	DESCRIPTION	COLOR	PART NO.
	Gasket Post		10148404
	Gasket – Top Backplate		10148405
	M5 x 65mm Phillips ovalhead machine screw	Oil Rubbed Bronze PVD Satin Nickel PVD Dark Bronze Matte Black	10148456 10148457 10148455 11800694
	Spindle Kit (HOPPE) <i>Includes:</i> 1 – 2 piece. spindle, 5 1/8" 2 – Set screws		10148458
	Key Cylinder, Lock (Schlage "C" keyway) For service replacement only. <i>NOTE: For Keyed Alike orders, use program C87P2.</i> <i>BS, ORBZ PVD, TP, WH, AB=Brass Face</i> <i>All other Marvin finishes=Chrome Face</i>	Brass Face Chrome Face	10830212 10830209
	Set Screw for Handle Assembly See Spindle kit		NA
	3/4" Handle Extension Requires 3/4" Spindle Extension	Oil Rubbed Bronze PVD Satin Nickel PVD Dark Bronze Matte Black	10148421 10148422 10148420 10148445
	3/4" Spindle Extension Kit (HOPPE) <i>Includes:</i> 1 – 2 piece. spindle 2 – Set screws		10148459
	2 1/4" Swinging Handle Set Kit – Interior Shades <i>Includes:</i> 1 – 3/4" extension handle 1 – Spindle, lever handle, 2 pc. assembly 1 – Installation instruction	Oil Rubbed Bronze PVD Satin Nickel PVD Dark Bronze Matte Black	21448106 21448107 21448105 21448108
	Lever Bushing, Swinging Handle Set – Contemporary	Gray Natural Black	10148448 02062202 10148020
	Spring Cartridge, Swinging Handle Set – Contemporary		10830452

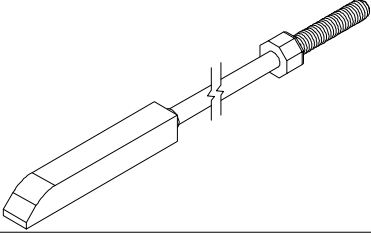
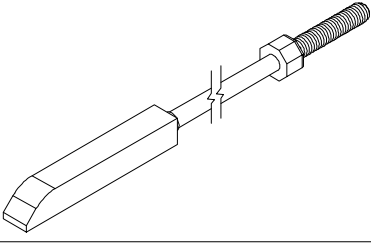
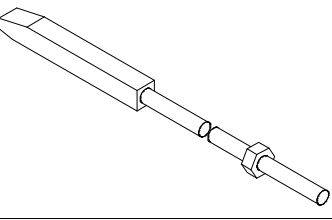
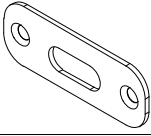
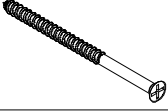
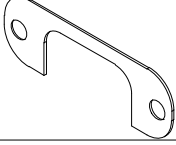
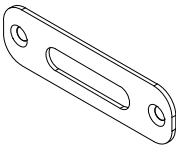
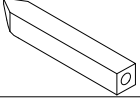
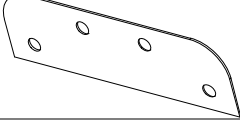
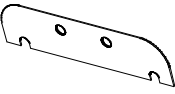
ILLUSTRATION NOT TO SCALE	DESCRIPTION	COLOR	PART NO.
	Locking Rod Assembly, Top Multi-Point Lock Inswing and Outswing Height Top Locking Rod Length CN 8-0 ht 51 7/16" CN10-0 ht 75 7/16"	Stainless Steel	05700179 05700196
	Locking Rod Assembly, Bottom Multi-Point Lock Inswing only Height Bottom Locking Rod Length CN 8-0 ht 34 9/32" CN10-0 ht 34 9/32"	Stainless Steel	05700170
	Locking Rod Assembly, Bottom for Multi-Point Lock Outswing only Solid stainless steel rod with 1/4" – 20 threads Bottom Locking Rod Length – 34 3/4"	Stainless Steel	10815179
	Head Jamb/ Sill Strike Plate <i>IFD head jamb and sill</i> <i>OFD head jamb</i>		05700082
	#10 x 3" Phillips Flat Head Screws <i>For Head Jamb Strike Plate at installation.</i>	Stainless Steel	02056011
	Shim, Head Jamb Strike <i>Usage: Prior to 8/31/2009</i> MOFD only		11100251
	Head Strike RT2 one wide <i>Includes:</i> 1 – Strike 2 – #10 x 3" Phillips flat head screws (02056011)		05700319
	Shoot Bolt, Beveled RT2 one wide		10815101
	4 1/2" x 4 1/2" Hinge Shim		18900502
	4 1/2" x 4 1/2" Hinge Shim Clad Frame		(18900504) NA replace with 18900502

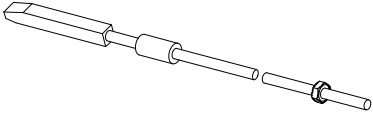
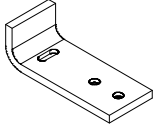


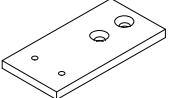
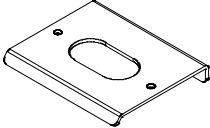
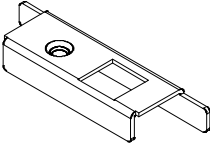
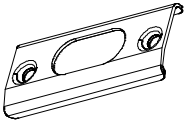
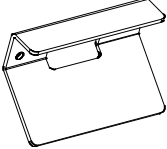
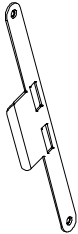
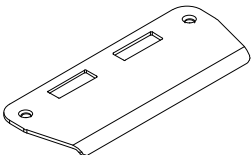
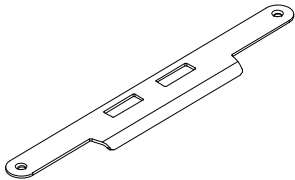
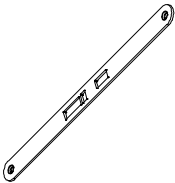
ILLUSTRATION NOT TO SCALE	DESCRIPTION	COLOR	PART NO.
	Shoot Bolt Assembly, IZ4 <i>Includes:</i> 1 - Spacer 1 - Hex Nut 1 - Shoot Bolt 1 - Lock Rod		18900450
	Header Reinforcement Bracket MOFD <i>Usage: 8/31/2009 - present</i> <i>Includes:</i> 1 - Bracket	Stainless Steel	11100249
	#8x1" Phillips Flat Head Screw <i>For Header Reinforcement Bracket</i>	Stainless Steel	11800645
	Header Reinforcement Bracket <i>Usage: Prior to 8/31/2009</i>	Replaced with 11100249	(11100250) NA
	Header Reinforcement Plate, IZ4 <i>Usage: Prior to 8/31/2009</i>	Replaced with 11100249	(18900451) NA
	Sill Strike Backer Plate <i>Outswing</i>		10148006
	Stile End Plate	LH RH	10148008 10148007
	Sill Strike, IZ3 <i>Outswing</i>		10148005

ILLUSTRATION NOT TO SCALE	DESCRIPTION	OPER./COLOR	PART NO.
	Sill Strike Backer Plate <i>Inswing</i>		10148009
	Strike Plate, Jamb and Inactive Panel –Mortise Lock or Multi-Point Lock 5/10/99 – Present (Amerock) <i>Inswing</i> <i>Includes:</i> 1 – Jamb strike plate 2 – #8x1" Brass Phillips flathead wood screws*	Stainless Steel Antique Brass Oil Rubbed Bronze PVD Brass PVD	05700300 05700301 05700302 10148177
Strike Plate, Inactive Panel–Mortise Lock or Multi-Point Lock 5/10/99 – Present (Amerock) <i>Inswing</i> <i>Includes:</i> 1 – Jamb strike plate 2 – #8x1" Brass Phillips flathead wood screws*			
	Strike Plate, Jamb – Mortise Lock or Multi-Point Lock* <i>Outswing</i> <i>Includes:</i> 1 – Jamb strike plate 2 – #8x1" Brass Phillips flathead wood screws	Stainless Steel Antique Brass Oil Rubbed Bronze PVD Brass PVD	05700309 05700310 05700311 10148182
	Strike Plate, Panel – Mortise Lock or Multi-Point Lock* <i>Outswing</i> <i>Includes:</i> 1 – Jamb strike plate 2 – #8x1" Brass Phillips flathead wood screws	Stainless Steel Antique Brass Oil Rubbed Bronze PVD Brass PVD	05700312 05700313 05700314 10148183
	Cover Plate, Active Mortise Lock or Multi-Point Lock* <i>Includes:</i> 1 – Cover plate 2 – #8x1" Phillips flathead wood screws	Stainless Steel Antique Brass Oil Rubbed Bronze PVD Brass PVD	05700306 05700307 05700308 10148179

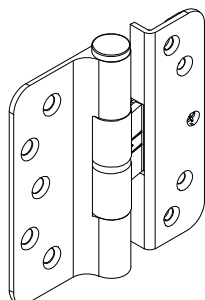
* Stainless Steel – 11800645, Dark Bronze – 11800652, PVD Brass – 11800536

NOTE: Dark Bronze screws are used with Antique Brass and Oil Rubbed Bronze PVD

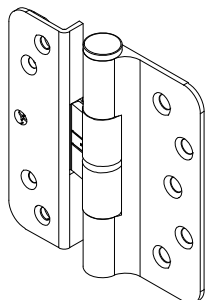
ILLUSTRATION

NOT TO SCALE

Note: Always view units from the exterior for handing. H = Hinge location.

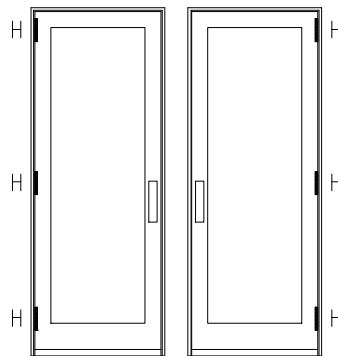


LH Hinge



RH Hinge

This panel uses the left hand hinge



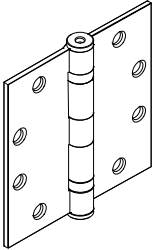
X-L

X-R

This panel uses the right hand hinge

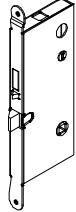
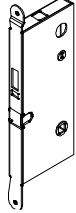
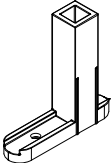
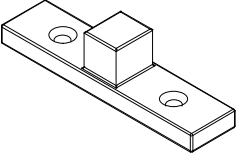
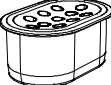


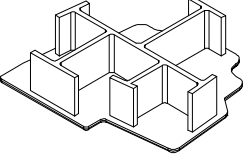
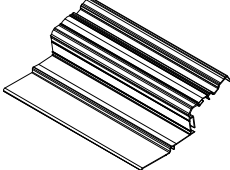
ILLUSTRATION NOT TO SCALE	DESCRIPTION	HINGE COLOR	LEFT PART NO.	RIGHT PART NO.
<p>Hinge Kit, Adjustable Includes: 1 - Adjustable hinge 1 - #10x2 1/2" Phillips flathead wood screws (jamb) 5 - #10x3/4" Phillips flathead wood screws (jamb, stationary stile) 4 - #8x1 1/2" Phillips flathead wood screws (panel)</p> <p>NOTE: Hinge part number includes the color matched screws. If you need to order the screws separately, they are listed below.</p>		Satin Taupe (TP) Goldtone (GT) Silver Frost (SF) Dark Bronze (DKBZ) Antique Brass (AB) White (WH) Satin Chrome (SC) Oil Rubbed Bronze (ORBZ) Oil Rubbed Bronze (ORBZ) PVD Brass (BS) PVD Satin Nickel (SN) PVD Polished Chrome (PC) Matte Black (MBK)	02101216 02101213 02101218 02101217 02101210 02101214 02101212 02101219 02101211 02101215 02101220 02101234 02101236	02101227 02101224 02101229 02101228 02101221 02101225 02101223 02101230 02101222 02101226 02101231 02101235 02101237
SCREW DESCRIPTION	SCREW PART NO./COLOR	MATCHING HINGE COLOR		
#8x1 1/2" Phillips flathead wood screws (panel). Quantity of four needed per hinge.	11865177 TP 11865172 GT 11865173 WH 02058013 DKBZ 11865176 BS PVD 11865175 Stainless Steel 11865178 MBK	TP GT WH AB, ORBZ PVD, DKBZ, ORBZ BS PVD, SC, SF, SN PVD, PC MBK		
#10x 3/4" Phillips flathead wood screws (jamb) (stationary stile). Quantity of five needed per hinge.	11800674 TP 11800670 GT 11800671 WH 11800669 DKBZ 11800673 BS PVD 11800672 Chrome 11800677 MBK	TP GT WH AB, ORBZ PVD, DKBZ, ORBZ BS PVD, SC, SF, SN PVD, PC MBK		
#10x2 1/2" Phillips flathead wood screws (jamb). Quantity of one needed per hinge.	11800683 TP 11800681 GT 11800682 WH 11800680 DKBZ 11800679 BS PVD 11800684 Stainless Steel 11800693 MBK	TP GT WH AB, ORBZ PVD, DKBZ, ORBZ BS PVD, SC, SF, SN PVD, PC MBK		

PARTS

ILLUSTRATION NOT TO SCALE	DESCRIPTION	COLOR	PART NO.
	<p>Hinge , 4 1/2" X 4 1/2" Ball Bearing Includes: 1 - Hinge 6 - #12x1"Phillips flat head wood screws 2 - #12x2 1/2"Phillips flat head screws</p> <p>NOTE: Hinge part number includes the color matched screws. If you need to order the screws separately, use the individual screw part number noted in the charts below.</p>	Stainless Steel Satin Chrome / Brass Bronze / Brass Brass	02100162 02101166 02101167 02101165
		Steel Hinge Available for Inswing Doors Only Satin Chrome / Steel Bronze / Steel	02101163 02101164

Screw Description	For Hinge	Color	Part No.
#12x1"Phillips flat head wood screws (SC=US26D) (BZ=US10A) (BS=US3) (SS=US32D)	Stainless Steel Satin Chrome / Steel Satin Chrome / Brass	Stainless Steel	02056069
	Bronze / Steel Bronze / Brass	Dark Bronze	02056010
	Brass	Brass	02056068

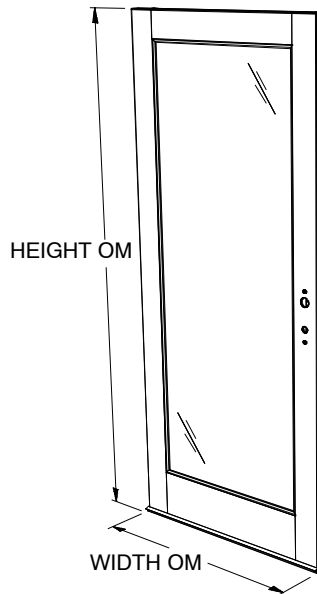
Screw Description	For Hinge	Color	Part No.
#12x2 1/2"Phillips flat head screws (SC=US26D) (BZ=US10A) (BS=US3) (SS=US32D)	Stainless Steel Satin Chrome / Steel Satin Chrome / Brass	Stainless Steel	02010311
	Bronze / Steel Bronze / Brass	Dark Bronze	02056067
	Brass	Brass	02010310

ILLUSTRATION NOT TO SCALE	DESCRIPTION	OPER./COLOR	PART NO.
	Mortise Lock, Active Multi-Point Lock (latch, dead bolt and head/foot shoot bolts)		05700130
	Mortise Lock, Inactive Panel Multi-Point Lock (head/foot shoot bolts)		05700131
	Shoot Bolt Guide <i>Includes:</i> 1 - Shoot bolt guide (10815186) 1 - #8x1 1/2" Phillips panhead wood screw (11800766)		10815199
	Sill Bolt, Stationary Panel <i>Includes:</i> 2 - #8 x 3" Phillips flathead wood screws (11800830)	Zinc Die Cast	11101856
	Drain Plug, Sill Inswing	Beige Bronze	10500253 10500249
	Head Jamb Spacer Tack; Stationary Panel		11860424
	Jamb Spacer Tack; Stationary Panel 3/4" Diameter Head		11860423
	Clad Mull Casing End Plug <i>(Clad Doors Only)</i> Inswing	LH Beige Bronze	10500255 10500267
		RH Beige Bronze	10500254 10500266
	Threshold Protector 30" length Inswing	EA Pkg 20	11869675 11869676

ORDERING REPLACEMENT PANELS FOR THE 2 1/4" INSWING AND OUTSWING FRENCH DOOR

When ordering replacement panels specify:

1. OM of panel;
NOTE: OM of panel does not include astragal, mull casing or sweep.
2. active, inactive or stationary;
 - a. Active – comes prepped for multi–point mortise lock and standard Marvin handle set. If Marvin Architectural Hardware prep is needed, specify brand.
 - b. Inactive – comes prepped for multi–point lock and standard Marvin handle–set. If Marvin Architectural Hardware prep is needed, specify brand.
 - c. Stationary – specify configuration and astragal or mull casing (if applicable).
 - d. Panel style.
3. handing;
4. glazing;
5. finish.
6. glazing bead profile
 - a. bevel
 - b. square



Wood or Clad Panel

NOTE: Weather strip is included with all panels (where applicable).

Active panels include panel sweep and multi–point mortise lock system.

Inactive panels include panel sweep, astragal, and multi–point lock system.

Stationary 1 wide panels include panel sweep.


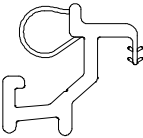

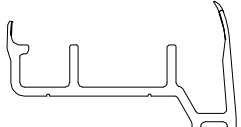
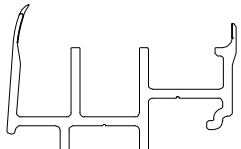


WEATHER STRIP

When ordering replacement weather strip specify:

1. quantity;
2. length;
3. part number;
4. description.

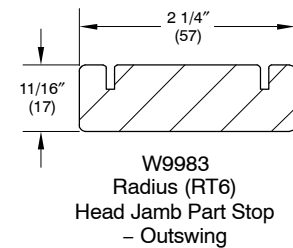
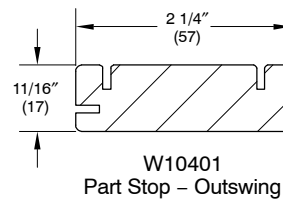
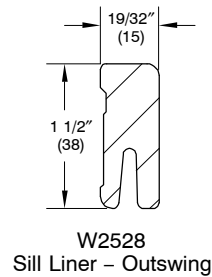
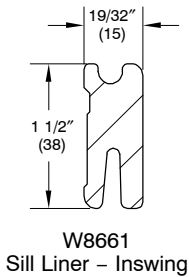
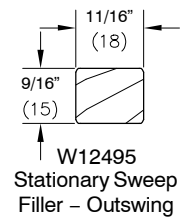
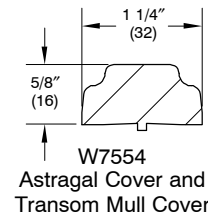
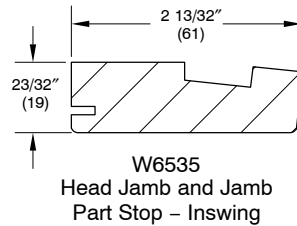
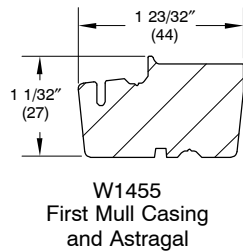
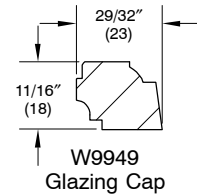
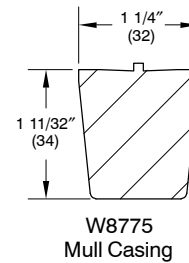
ILLUSTRATION NOT TO SCALE	DESCRIPTION	LENGTH	COLOR	PART NUMBER
	Weather Strip, Frame V1707	120" (3048)	Beige Black	11191299 11191399
	Weather Strip, Frame Outswing Arch Top V1732 <i>3-31-2009 to present</i> <i>Replaced V1304</i>	150" 150"	Beige Black	11191499 11191599
	Weather Strip, Frame Outswing Arch Top V1733 <i>3-31-2009 to present</i> <i>Replaced V1304</i>	151" 151"	Beige Black	11191699 11191799
	Dust Block, Part Stop 1 3/8" x 3/8" x 1/2"		Gray Beige	15600010 15600011
	Dust Block, Astragal or Panel 1 3/8" x 1/4" x 3/8"			10500049
	Small Corner Seal Inswing		Beige Black	01040368 01040369
	Flex-Bulb Weather Strip, Sill V794 Inswing	87 9/16" 164 3/4" 164 3/4"	Beige Beige Black	15180276 15180798 15180799
	Offset Bulb Weather Strip, Parting Stop, Frame, Mull Casing, Transom and Astragal V796	41 1/4" 92 7/8" 92 7/8" 164 13/16"	Beige Beige Black Beige	15171136 15170082 15170083 15172140
	Connecting Barb V803 NOTE: Color may vary depending on current stock.	Specify Length L/F		15812999

WEATHER STRIP

ILLUSTRATION <i>NOT TO SCALE</i>	DESCRIPTION	LENGTH	OPER./COLOR	PART NUMBER
	Inactive Panel Stile Center V780 Inswing	150"	Beige Black	15174099 15174098
	Weather Strip, Sill V1659 Outswing/Arch Top Outswing	35 17/64" 41 17/64" 70 29/64" 82 29/64" 150"	Beige	11197030 11197036 11197060 11197070 11197099
		35 17/64" 70 29/64" 82 29/64" 150"	Black	11197130 11197160 11197170 11197199
	Weather Strip, Stile V020	79 9/16" 92 15/16" 150"	Beige	11197968 11197982 11197999
		150"	Black	11197998
	Sweep, Active and Inactive Panel V2416 Outswing/Arch Top Outswing	70 1/2"	Beige Black	11181870 11181871
	Sweep, Stationary Panel V2427 Outswing/Arch Top Outswing	70 1/2"	Beige Black	11181798 11181799
	Weather Strip, Panel Cover V018 Outswing	150"	Beige Black	11197799 11197798
	Weather Strip, Inactive Panel V1706 Outswing/Arch Top Outswing	121"	Beige Black	15618199 15618299

ORDERING REPLACEMENT WOOD PARTS FOR THE 2 1/4" FRENCH DOOR

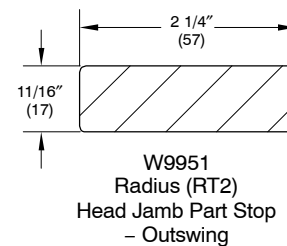
	Wood	Clad
Mull Casing	W8775	W8775
Glazing Cap	W9949	
First Mull Casing and Astragal	W1455	W1455
Head Jamb and Jamb Part Stop – Inswing	W6535	W6535
Astragal Cover and Transom Mull Cover	W7554	W7554
Stationary Sweep Filler	W12495	
Sill Liner (Oak) – Inswing	W8661	
Sill Liner (Oak) – Outswing	W2528	
Part Stop	W10401	
Head Jamb Part Stop	W9983	
Radius Head Jamb Part Stop – Outswing	W9951	W9951



TO ORDER REPLACEMENT PARTS

When ordering replacement parts specify:

1. profile number;
2. rough opening;
3. length;
4. handing;
5. finish (where applicable).

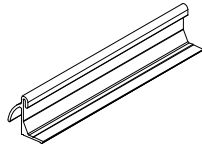


**ORDERING REPLACEMENT VINYL, ALUMINUM OR FIBERGLASS PARTS FOR THE
 2 1/4" FRENCH DOOR**

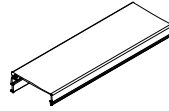
	Wood	Clad
Hydro-Optimizer Reinforcement – Beige or Bronze	A1222	A1222
Hydro-Optimizer – Beige or Bronze	A1251	A1251
Head Jamb, Jamb Parting Stop	---	A836
Astragal Cladding	---	A772
Mullion Casing Base	---	A771
Ultrrex Sill, 4 9/16" Jamb – Beige or Bronze	F256	F256
Ultrrex Sill, 6 9/16" Jamb – Beige or Bronze	F257	F257
Panel Drip – Beige or Black	V940	V940
Stationary Panel Sill Spacer – Beige or Black	V941	V941



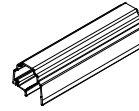
A1222 – Hydro-Optimizer
 Reinforcement Inswing
 144"
 BG – 18548499
 BZ – 18548399



A1251 – Hydro-Optimizer
 Inswing



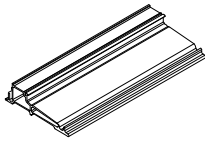
A836 – Head Jamb,
 Jamb Parting Stop
 Inswing



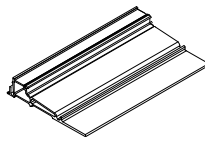
A772 – Astragal
 Cladding
 Inswing



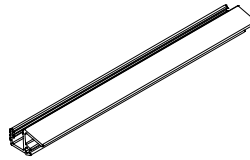
A771 – Mullion
 Casing Base
 Inswing



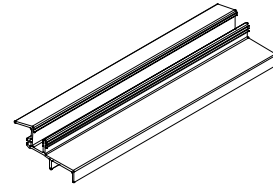
F256 – Ultrrex Sill,
 4 9/16" Jamb
 Inswing



F257 – Ultrrex Sill,
 6 9/16" Jamb



V940 – Panel Drip
 Inswing



V941 – Stationary
 Panel Drip/Sill Spacer
 Inswing

TO ORDER REPLACEMENT PARTS

When ordering replacement parts specify:

1. profile number;
2. rough opening;
3. length;
4. handing;
5. finish (where applicable).

PARTS FOR LOCK STATUS SENSOR

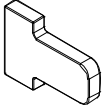
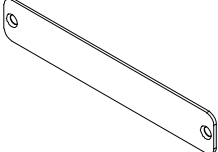
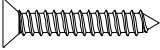
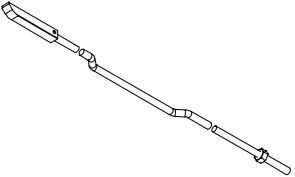
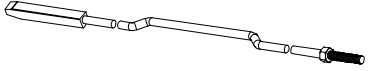
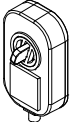
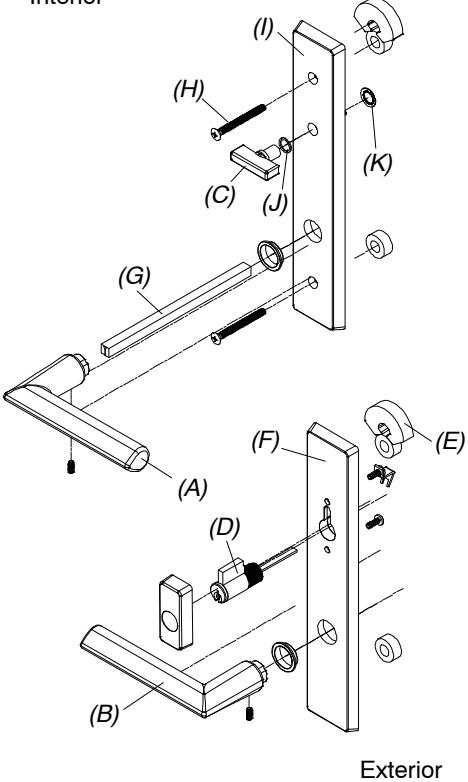
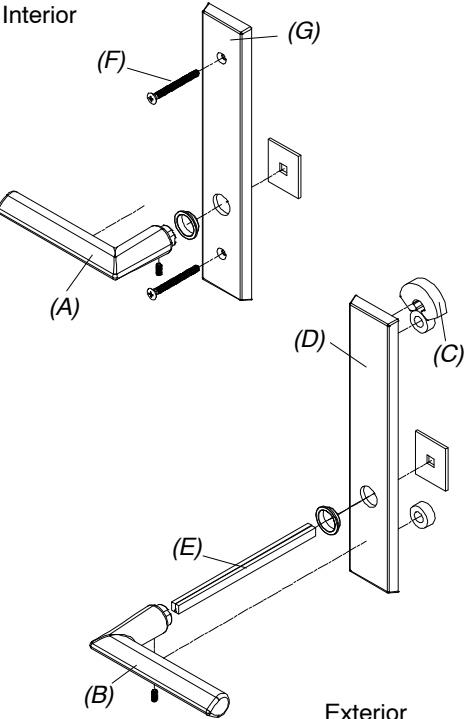
ILLUSTRATION NOT TO SCALE	DESCRIPTION	OPER./ COLOR	PART NO.
	Tailpiece, Non-keyed, Button Switch	Stainless Steel	10501844
	Cover, Transmitter	Brushed Stainless Steel	10501822
	#8-18 x 1" Type AB, Full Thread <i>Used for Transmitter Cover</i> <i>Need quantity of 2 for each part</i>		11800769
	Lock Rod, Transmitter Recess, Shoot Bolt, LH <i>For Inswing 2 1/4" French Door and Inswing 2 1/4" Arch Top Door</i>	Brushed Stainless Steel	10501838
	Lock Rod, Transmitter Recess, Shoot Bolt, RH <i>For Inswing 2 1/4" French Door and Inswing 2 1/4" Arch Top Door</i>	Brushed Stainless Steel	10501841
	Lock Rod, Transmitter Recess, Shoot Bolt at Sill, LH <i>For Outswing 2 1/4" French Door and Outswing 2 1/4" Arch Top Door</i>	Brushed Stainless Steel	10501839
	Lock Rod, Transmitter Recess, Shoot Bolt at Sill, RH <i>For Outswing 2 1/4" French Door and Outswing 2 1/4" Arch Top Door</i>	Brushed Stainless Steel	10501842
	Micro Switch Assembly	Black	10501824


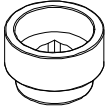
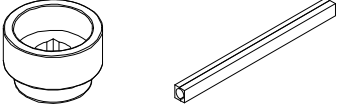
ILLUSTRATION NOT TO SCALE	DESCRIPTION	OPER./COLOR	PART NO.
<p>Interior</p> <p>Exterior</p>	<p>Handle Assembly, Active Panel Includes: 1 - Interior lever (A) with spindle, escutcheon plate and hardware 1 - Exterior lever (B) with escutcheon plate and hardware 1 - Thumb turn (C) with hardware 1 - Keyed cylinder (D) with housing and hardware 1 - Exterior escutcheon plate gasket (E) 1 - Exterior escutcheon plate (F) 1 - Two piece spindle (G) 2 - #10-32 x 2 1/2" Phillips oval head machine screws (H) 1 - Interior Escutcheon plate (I) 2 - Keys</p>	<p>Polished Chrome</p>	<p>21448117</p>
<p>Interior</p> <p>Exterior</p>	<p>Handle Assembly, Inactive Includes: 1 - Interior lever (A) with spindle, escutcheon plate and hardware 1 - Exterior lever (B) with escutcheon plate and hardware 1 - Exterior escutcheon plate gasket (C) 1 - Exterior escutcheon plate (D) 1 - Two piece spindle (E) 2 - #10-32 x 2 1/2" Phillips oval head machine screws (F) 1 - Interior Escutcheon plate (G)</p>	<p>Polished Chrome</p>	<p>21448148</p>

When ordering replacement 2 1/4" Panel Door parts specify:



1. type of unit;
2. part number;
3. description.

ILLUSTRATION NOT TO SCALE	DESCRIPTION	COLOR	PART NO.
<p>Interior</p>  <p>Exterior</p>	<p>Handle Assembly, Active Panel Includes: 1 - Interior lever (A) with 10148414 spindle, escutcheon plate and hardware 1 - Exterior lever (B) with escutcheon plate and hardware 1 - Thumb turn (C) with hardware 1 - Keyed cylinder (D) with housing and hardware 1 - Exterior escutcheon plate gasket (E) 1 - Exterior escutcheon plate (F) 1 - Two piece spindle (G) 2 - M5 x 65mm Phillips ovalhead machine screws (H) 1 - Interior escutcheon plate (I) 1 - Thumb turn washer (J) 1 - Thumb turn push nut (K) 2 - Keys</p>	<p>Satin Taupe</p>	<p>21448121</p>
<p>Interior</p>  <p>Exterior</p>	<p>Handle Assembly, Inactive Includes: 1 - Interior lever (A) with 00142006 spindle, escutcheon plate and hardware 1 - Exterior lever (B) with escutcheon plate and hardware 1 - Exterior escutcheon plate gasket (C) 1 - Exterior escutcheon plate (D) 1 - Two piece spindle (E) 2 - M5 x 65mm Phillips ovalhead machine screws (F) 1 - Interior escutcheon plate (G)</p>	<p>Satin Taupe</p>	<p>21448125</p>

OBSOLETE PARTS- CONTEMPORARY

ILLUSTRATION NOT TO SCALE	DESCRIPTION	OPER./COLOR	PART NO.
	<p>M5 x 65mm Phillips ovalhead machine screw</p>	<p>Satin Taupe</p>	<p>10148454</p>
	<p>3/4" Handle Extension Requires 3/4" Spindle Extension</p>	<p>Satin Taupe</p>	<p>10148419</p>
	<p>2 1/4" Swinging Handle Set Kit – Interior Shades <i>Includes:</i> 1 – 3/4" extension handle 1 – Spindle, lever handle, 2 pc. assembly 1 – Installation instruction</p>	<p>Satin Taupe</p>	<p>21448104</p>


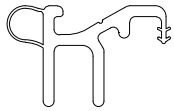
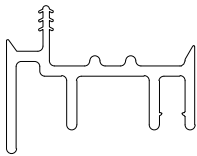
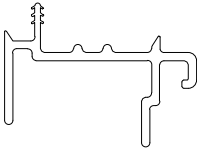
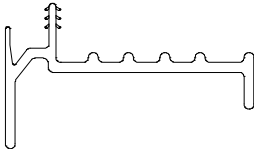
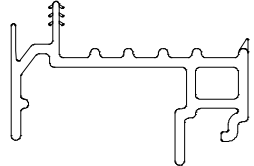
OBSOLETE PARTS

ILLUSTRATION NOT TO SCALE	DESCRIPTION	OPER./COLOR	PART NO.
	<p>Stop clip with screws NA as individual part</p>		<p>NA</p>
	<p>Pkg, Panel Drip – WOFD July 30, 2012 – July 6, 2015 <i>A2408 Panel Drip (For Custom Color match see Profile section), Foam Tape #6 x 1 1/4" flat head screws</i></p>	<p>1-6 Beige 2-0 Beige 2-6 Beige 2-8 Beige 3-0 Beige 1-6 Bronze 2-0 Bronze 2-6 Bronze 2-8 Bronze 3-0 Bronze</p>	<p>11100277 11100278 11100279 11100280 11100281 11100287 11100288 11100289 11100290 11100291</p>

OBSOLETE WEATHER STRIP

When ordering replacement weather strip specify:

1. quantity;
2. length;
3. part number;
4. description.

ILLUSTRATION NOT TO SCALE	DESCRIPTION	LENGTH	OPER./COLOR	PART NUMBER
	Weather Strip, Frame Pre 3-30-2009 V1304 Arch Top	120" (3048) 144" (3658)	Beige Black Beige Black	NA
	Weather Strip, Sill Pre 3-30-2009 V776 Outswing	87 11/16" 164 7/8" 164 7/8"	Beige Beige Black	11197276 11197296 11197297
	Sweep, Active and Inactive Panel Pre 3-30-2009 V779 Outswing	CN 2/0 CN 2/6 CN 2/8 CN 3/0 CN 3/0 CN 3/6 CN 3/6	Beige Beige Beige Beige Black Beige Black	11197420 11197426 11197428 11197430 NA 11197436 11197437
	Sweep, Stationary Panel Pre 3-30-2009 V778 Outswing	CN 3/0 CN 3/0 CN 3/6 150" 150"	Beige Black Beige Beige Black	11197330 11197331 11197336 11197399 11197398
	Sweep, Active and Inactive Panel Pre 6-03-2015 V1713 Outswing/Arch Top Outswing	CN 2/6 CN 2/6 CN 3/0 CN 3/0 CN 3/6 CN 3/6	Beige Black Beige Black Beige Black	11181126 11181226 11181130 11181230 11181136 11181236
	Sweep, Stationary Panel V1657 Pre 6-03-2015 Outswing/Arch Top Outswing	150"	Beige Black	11181399 11181499

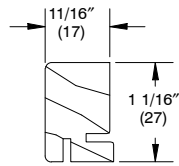
ORDERING OBSOLETE REPLACEMENT WOOD, VINYL, ALUMINUM OR FIBERGLASS PARTS FOR THE 2 1/4" FRENCH DOOR

TO ORDER REPLACEMENT PARTS

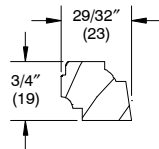
When ordering replacement parts specify:

1. profile number;
2. rough opening;
3. length;
4. handing;
5. finish (where applicable).

	Wood	Clad
Jamb Stop	W8715	W8715
Glazing Cap	W4019	
Panel Drip (Active and Stationary Panels)	A2408	A2408



W8715 – Stop, Jamb



W4019 – Glazing Cap



A2408 – Panel Drip Outswing