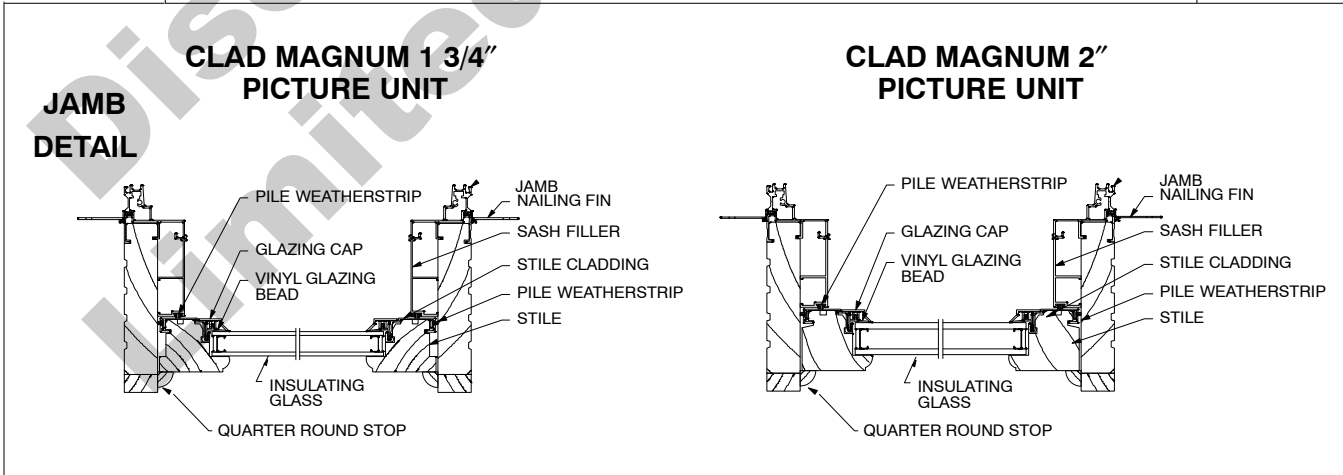
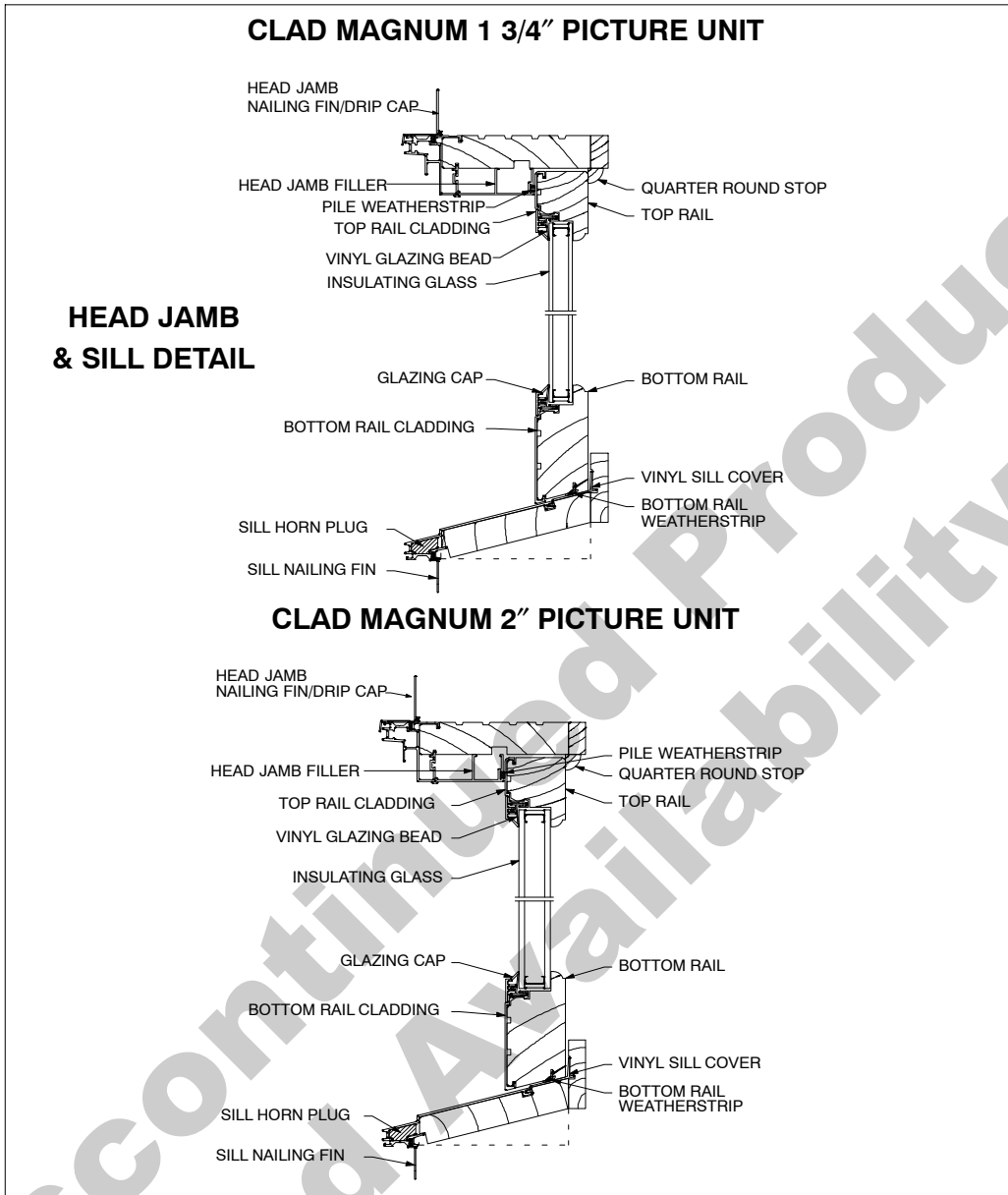


NOTE: Not to scale; specifications subject to change without notice.



NOTE: Not to scale; specifications subject to change without notice.

When ordering replacement Magnum parts specify:

- 1.type of unit;
- 2.part number;
- 3.description.

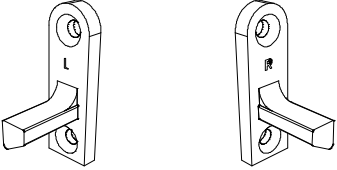
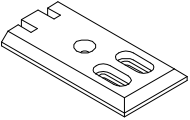
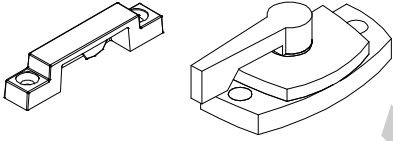
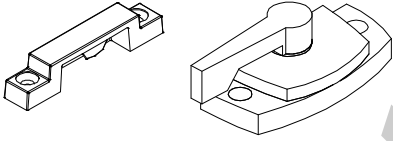
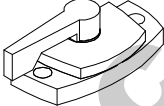
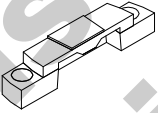
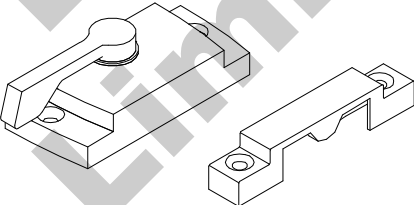
ILLUSTRATION <i>NOT TO SCALE</i>	DESCRIPTION	OPER/COL- OR	PART NO.
 <p>Left Hand Right Hand</p>	<p>Sash Pivot Includes: 1 – Sash pivot 2 – #10 x 1" Phillips flathead wood screws</p> <p>NOTE: Pivot handing is viewed from the interior</p>	<p>LH RH</p>	<p>11870462 11870463</p>
	<p>Sash Retainer Plate Includes: 1 – Sash retainer plate 3 – #8 x 1" Phillips flathead wood screws</p>	<p>TP BZ WH</p>	<p>11870468 11870464 11870500</p>
	<p>Sash Lock and Keeper, Complete Package of 200 Includes: 200 – Sash lock 200 – Keeper 800 – #7x7/8" Phillips flathead wood screws</p>	<p>Satin Taupe Bronze White</p>	<p>11900925 11900920 11900910</p>
	<p>Sash Lock and Keeper, Complete Includes: 1 – Sash lock 1 – Keeper 4 – #7 x 7/8" Phillips flathead wood screws</p>	<p>Satin Taupe Bronze White</p>	<p>11869399 11869395 11869396</p>
	<p>Sash Lock Includes: 1 – Sash lock 2 – #7 x 7/8" Phillips flathead wood screws</p>	<p>TP BZ WH BS</p>	<p>10818034 10818033 10840026 05600082</p>
	<p>Keeper Includes: 1 – Keeper 2 – #7 x 7/8" Phillips flathead wood screws</p>	<p>TP BZ WH BS</p>	<p>10818035 10818032 10840012 05600083</p>
	<p>Historic Sash Lock and Keeper, Complete Includes: 1 – Historical sash lock WH – 10840013 BS – available in package only 1 – Keeper WH – 10840014 BS – available in package only 4 – #6 x 1" Phillips flathead wood screws</p>	<p>WH BS</p>	<p>11869383 05600044</p>

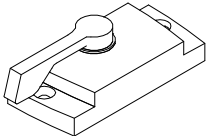
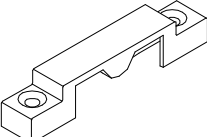
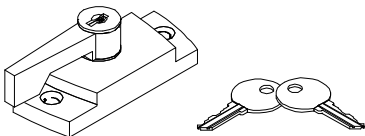
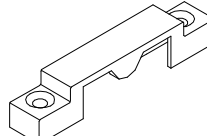
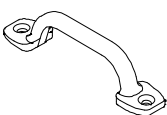

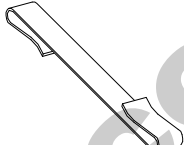
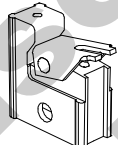
ILLUSTRATION NOT TO SCALE	DESCRIPTION	COLOR	PART NO.
	<p>Historic Sash Lock Includes: 1 - Historical sash lock 2 - #6 x 1" Phillips flathead wood screws</p>	WH	10840013
	<p>Keeper, Historic Includes: 1 - Keeper 2 - #6 x 1" Phillips flathead wood screws</p>	WH	10840014
	<p>Sash Lock, Keyed Includes: 1 - Keyed lock 2 - Keys 2 - #6 x 1" Phillips flathead wood screws</p>	TP BZ WH	05590634 05590632 05590633
	<p>Keeper For keyed sash lock Includes: 1 - Keeper 2 - #6 x 1" Phillips flathead wood screws</p>	TP BZ WH	10817047 10817043 10840014
	<p>Sash Lift Includes: 1 - Sash lift 2 - #8 x 1" Slotted ovalhead screws TP - 11800886 WH - 11800887 BZ - 11800888 BS - 11800889</p>	TP BZ WH BS	10500598 10500557 10500556 10500558
	<p>S-Hook, Short, 1/4" (6) Wide Need 1 per balance or 4 per sash Top sash balance</p>		11870727
	<p>S-Hook, Long, 1/4" (6) Wide Need 1 per balance or 4 per sash Bottom sash balance</p>		11870731
	<p>Locking Terminal</p>		11870460

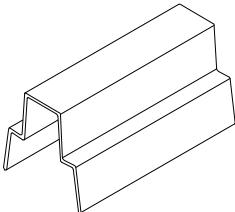
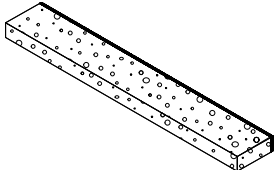
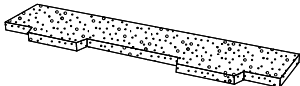
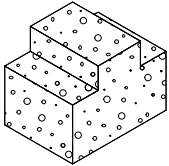
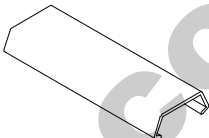

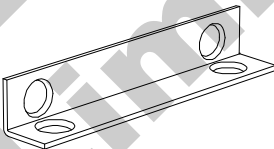
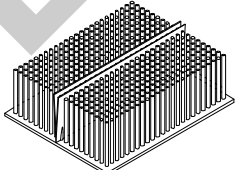
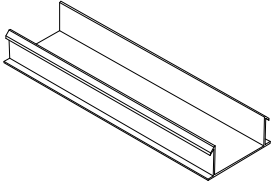
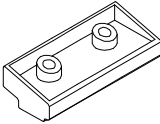
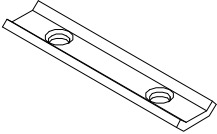
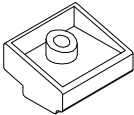
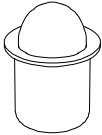

ILLUSTRATION NOT TO SCALE	DESCRIPTION	OPER./ COLOR	PART NO.
	<p>Sash Stop, Vinyl V458</p> <p>When ordering specify:</p> <ol style="list-style-type: none"> 1. length; 2. part number; 3. color. <p style="text-align: right;">1 3/4" (44)</p> <p style="text-align: right;">60" (1524)</p>	<p>WH BG</p> <p>WH BG</p>	<p>11870135 11870134</p> <p>11870998 11870999</p>
	<p>Jamb Liner, Foam M004 With PVC edge 9/16" x 1 7/16" Magnum Single Hung and Simulated Triple Hung</p>	<p>Specify Length</p>	<p>10500014</p>
	<p>Foam Gasket M0124</p>	<p>WH</p>	<p>11869514</p>
	<p>Foam Plug (Chimney Block) M0129 1 3/8" x 1" x 1" Located at the bottom of the vinyl jamb liner</p>	<p>WH</p>	<p>10500205</p>
	<p>Sash Limiter, Top Sash V454 Specify length needed</p>	<p>BG WH</p>	<p>11870997 11870996</p>
	<p>Sash Limiter, Bottom Sash M726 <i>Includes:</i> 1 - Sash limiter 2 - #6 x 5/8" Phillips flathead wood screws</p>	<p>BG</p>	<p>05070431</p>
	<p>Stationary Sash Bracket <i>Includes:</i> 1 - Bracket 4 - #7 x 7/8" Phillips flathead wood screws</p>	<p>ZYD</p>	<p>11100300</p>
	<p>Fin Seal Pad</p>		<p>10500223</p>

ILLUSTRATION NOT TO SCALE	DESCRIPTION	OPER./ COLOR	PART NO.
	<p>Hardware Clip, Vinyl V611</p> <p><i>Includes:</i> 1 - Clip 2 - #7 x 3/4" Phillips panhead wood screws</p> <p>Magnum Single Hung, Simulated Triple Hung and Triple Hung</p> <p>Specify length needed</p>	WH	16215004
	<p>Sill Horn Mulling Plug, Clad M055</p> <p><i>Includes:</i> 1 - Plug 2 - Screws</p>	Zinc	No longer available
	<p>Head Jamb Mulling Tie Bar, Clad M976</p> <p><i>Includes:</i> 1 - Tie bar 2 - Screws</p>	Mill Finish	11100900
	<p>Sill Plug, Clad MISC 054</p> <p><i>Includes:</i> 1 - Plug 1 - Screw</p>	CL	11867824
	<p>Bullet Catch, Historical</p>	BS	01010459
	<p>Bullet Catch Receiver, Historical</p>	BS	01010457

When ordering replacement Magnum parts specify:

1. type of unit;
2. part number;
3. description.

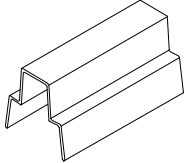
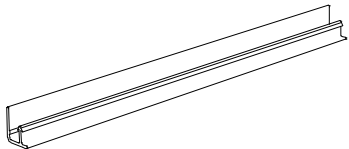
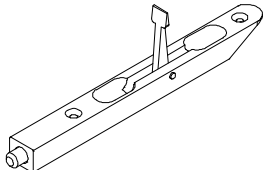
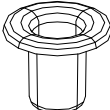

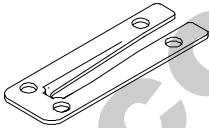
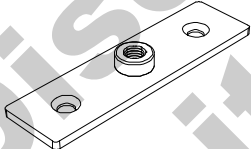


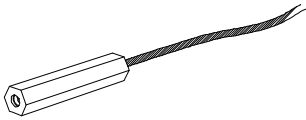
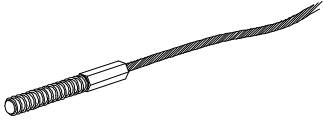

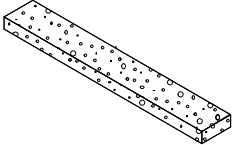
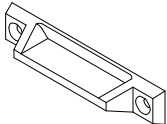
ILLUSTRATION NOT TO SCALE	DESCRIPTION	OPER./ COLOR	PART NO.
	Sash Stop, Vinyl V458 60" (1524)	BG WH	11870999 11870998
	Stile Slide V233 96" (2438) 120" (3048)	BG	15619997 15619998
	Jamb Bolt, Solid Brass M630 <i>Includes:</i> 1 - Jamb bolt	BS	00143068
	Thimble M629 Jamb bolt receiver	BS	Check for availability
	Post, Sash Mount 1/4" x 1 1/4" Hex Socket Machine Screw		02061459
	Sash Mount M606 <i>Includes:</i> 1 - Sash mount 4 - #6 x 1 1/2" Phillips flathead wood screws		11860023
	Jamb Mounting Plate M093 <i>Includes:</i> 1 - Jamb mounting plate 2 - #8 x 3/4" Phillips flathead wood screws	Mill Finish	11860040
	Pulley, Steel M625		02165528
	Bracket M623 Used with Pulley <i>Includes:</i> 1 - Bracket 1 - #10 x 3/4" Phillips head machine screw (bracket) 1 - #10 x 2" slotted machine screw (pulley) 1 - 7/16" spacer nut (pulley)		02165529

ILLUSTRATION NOT TO SCALE	DESCRIPTION	OPER./ COLOR	PART NO.
	<p>Cable M628 With female receptacle Specify daylight opening height of 1 sash</p>		02165526
	<p>Cable M627 With male stud Specify daylight opening height of 1 sash</p>		02165525
	<p>Ball End M624</p>		02165527
	<p>Vinyl Jamb Liner Foam M632 1 15/32" x 9/16"</p>	Specify Length	10500030
	<p>Sash Lift <i>Includes:</i> 1 - Sash lift 2 - #10 x 1" Phillips flathead wood screws</p>	BZ WH BS	10818030 10840015 05600040

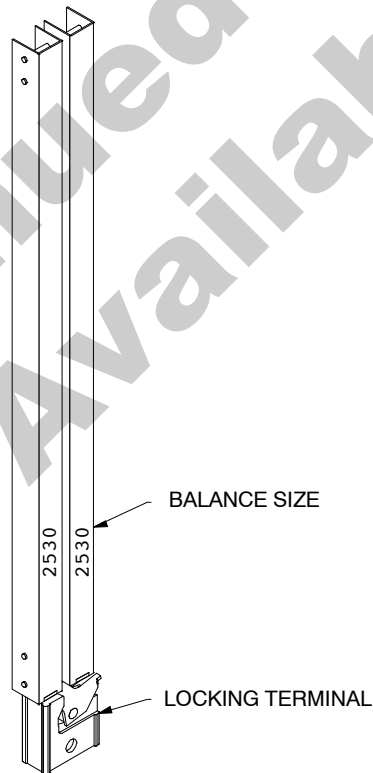
DUAL BALANCE SYSTEMS FOR THE MAGNUM DOUBLE HUNG AND SINGLE HUNG.

Manufacturer numbers are stamped on the balance tube assembly above the locking terminal.

When ordering a replacement dual balance system, specify the following:

1. Original order number if available
2. The balance size (see illustration). Often the two numbers on the tubes are different. Always provide both numbers. For example: 2530/2530 (both numbers the same), 5210/3220 (different numbers)
3. The top or bottom sash;
4. The weight of the sash.
5. The quantity of dual balance systems. Do **NOT** specify as *pairs* or *sets*. If one system is needed, specify: quantity of 1. If four systems are needed, specify a quantity of 4.

NOTE: Contact your Marvin representative for pricing.



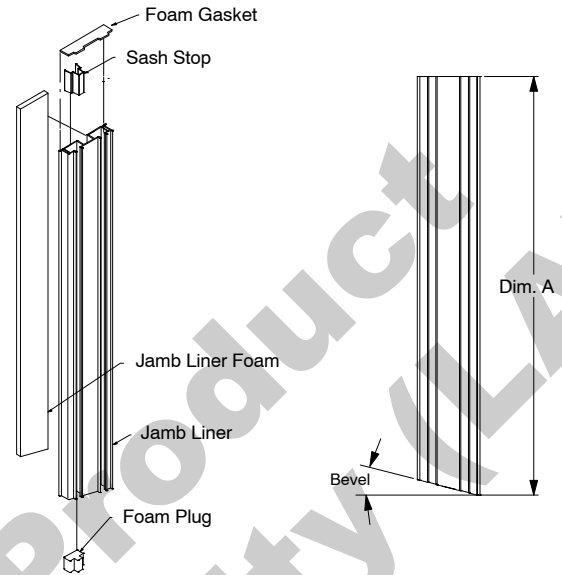
DUAL BALANCE SYSTEM

ORDERING REPLACEMENT JAMB LINERS

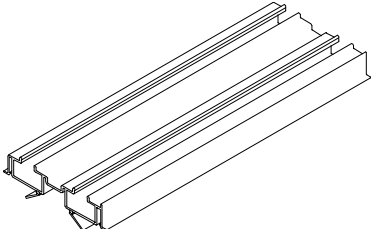
Replacement flange or clip mount jamb liners are cut to length to fit magnum units and includes foam plugs (chimney block), foam backing, sash stops and foam gaskets.

To order specify:

1. type of unit;
2. length (see dimension A, to long side of bevel) or if lineal is required specify part number;
3. flange or clip mount;
4. color;
5. sill bevel if other than standard 14°
6. left, right or pair (viewed from exterior).

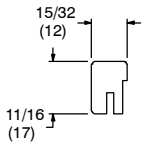


MAGNUM DOUBLE HUNG FLANGE MOUNT

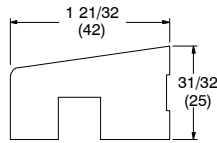
ILLUSTRATION <i>NOT TO SCALE</i>	DESCRIPTION	LENGTH	PART NUMBER
	<p>Jamb Liner V1374 (Replaced V398)</p> <p>WH BG</p>	<p>192" (4877) 192" (4877)</p>	<p>16215016 16216996</p>

CURRENT REPLACEMENT WOOD PARTS FOR WOOD MAGNUM UNITS

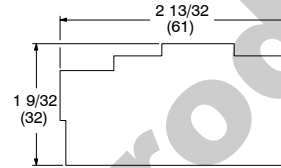
Head Jamb Parting Stop	W7082
Half Screen Nosing (WMSH)	W7178
Sash Opening Filler (WMSH)	W7188
Stationary Sash Filler (WMSH)	W7186



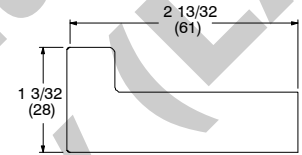
W7082 – Head Jamb Parting Stop



W7178 – Half Screen Nosing (WMSH)

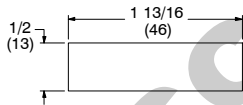


W7186 – Stationary Sash Filler (WMSH)

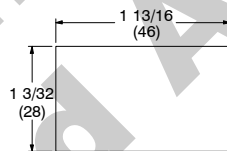


W7188 – Sash Opening Filler (WMSH)

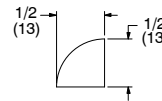
Picture Units	
Head Jamb Filler for 2 1/2" Picture Unit	W6260
Jamb Filler for 2 1/2" Picture Unit	W6262
Quarter Round Stop	W7003



W6260 – Head Jamb Filler for 2 1/2" Picture Unit



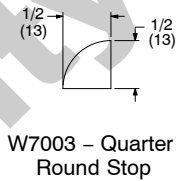
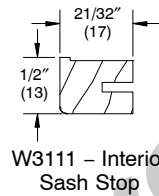
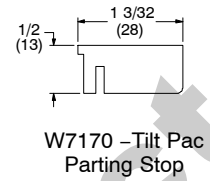
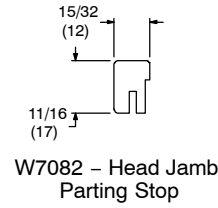
W6262 – Jamb Filler for 2 1/2" Picture Unit



W7003 – Quarter Round Stop

**CURRENT REPLACEMENT WOOD PARTS
FOR CLAD MAGNUM DOUBLE HUNG**

Head Jamb Parting Stop	W7082
Tilt Pac Parting Stop	W7170
Stationary Sash Filler (CMSH)	W7199
Interior Sash Stop – Pic./Transom	W3111
Interior Sash Stop – Transom	W2021
Picture Units	
Quarter Round Stop	W7003



TO ORDER REPLACEMENT WOOD PARTS

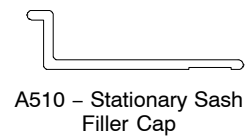
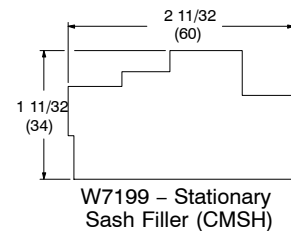
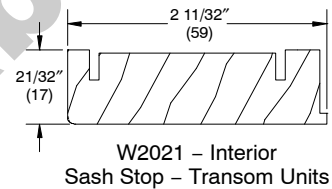
When ordering replacement wood parts specify:

1. type of unit;
2. profile number;
3. rough opening or lineal length;
4. finish.

**CURRENT REPLACEMENT ALUMINUM PARTS
FOR CLAD MAGNUM DOUBLE HUNG UNITS**

Please reference the Aluminum Chapter (located online only) for select and standard color part numbers.

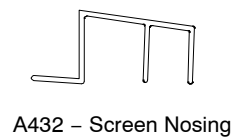
Stationary Sash Filler Cap	A510
Screen Nosing	A432



TO ORDER REPLACEMENT ALUMINUM PARTS

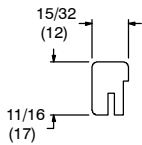
When ordering replacement aluminum parts specify:

1. type of unit;
2. profile number;
3. color;
4. rough opening or lineal length.

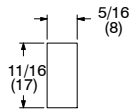


**CURRENT REPLACEMENT WOOD PARTS FOR
WOOD MAGNUM SIMULATED TRIPLE HUNG**

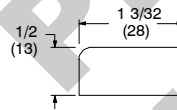
Head Jamb Parting Stop	W7082
Upper Jamb Parting Stop	W6083
Screen Bullnose	W7013
Half Screen Nosing	W7196



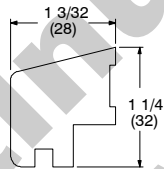
W7082 – Head Jamb Parting Stop



W6083 – Upper Jamb Parting Stop



W7013 – Screen Bullnose



W7196 – Half Screen Bullnose

TO ORDER REPLACEMENT WOOD PARTS

When ordering replacement wood parts specify:

1. type of unit;
2. profile number;
3. rough opening or lineal length;
4. finish.

ORDERING REPLACEMENT SASH FOR MAGNUM DOUBLE HUNG UNITS

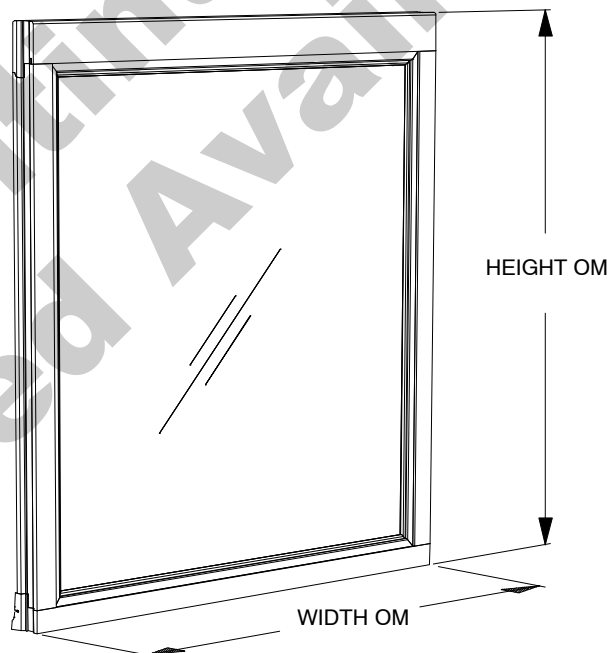
When ordering replacement sash specify:

1. type of unit
2. which sash is being replaced – top, bottom, center or set;
3. size;
 - a. top or bottom (call number or OM of sash)
 - b. set (call number or sash opening, indicate if unequal glass height)
4. glazing;
5. finish;

ORDERING REPLACEMENT PICTURE SASH FOR MAGNUM DOUBLE HUNG UNITS

To order replacement picture sash specify:

1. type of unit
2. size (OM of sash);
3. sash thickness 2";
4. glazing;
5. finish;
6. sill bevel if other than standard 14° (wood only).



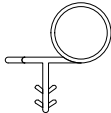


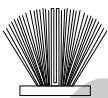



Exterior View
(top sash shown)

ORDERING REPLACEMENT WEATHER STRIP FOR MAGNUM DOUBLE HUNG UNITS

When ordering replacement weather strip specify:

1. quantity;
2. color;
3. part number;
4. description.

ILLUSTRATION <i>NOT TO SCALE</i>	DESCRIPTION	LENGTH	PART NUMBER
	Dual Seal Weather strip, Check Rail V116 Color: White	84" (2134)	15828400
	Hinged Leaf Weather strip, Parting Stop V245 Color: White	84" (2134)	15818400
	Bulb Weather strip, Bottom Rail V192 Color: Beige	84" (2134)	15900058
	Bulb Weather strip, Center Sash Stile V114 Magnum Triple Hung only Color: Beige	Specify length	11107532
	Interlock Weather strip, Check Rail V117 Magnum Triple Hung only Color: Beige	48" (1219) 68" (1727)	15813995 15813996
	Pile Weather strip, Check Rail M650 5/8" x 1 1/2" x 5/16" Magnum Triple Hung only Color: Beige		15600509
	Connecting Barb V803 NOTE: Color may vary depending on current stock.	Specify Length	15812999

ORDERING REPLACEMENT SCREENS FOR WOOD MAGNUM DOUBLE HUNG UNITS

There are no standard size screens for wood magnum units. Screens are standard with aluminum surround and charcoal colored fiberglass 18 x 16 screen mesh. Aluminum mesh is available as an option in black, charcoal, bright aluminum or bright bronze. Determine the outside measurement of the existing screen. Surrounds are available in bronze, white, brown and pebble gray.

When ordering replacement screen specify:

1. product and screen type;
2. size; – If there is no existing screen from which to obtain the OM of the screen, determine the size of the screen by using the conversion charts below. The daylight opening is the measurement of the visible glass.
3. color;
4. mesh type (if other than standard).

FULL SCREEN FOR WOOD MAGNUM DOUBLE HUNG

Conversion	Width	Height
Daylight opening to OM of aluminum full screen	+ 7"	x 2 + 8 3/4"

HALF SCREEN FOR WOOD MAGNUM SINGLE HUNG

Conversion	Width	Height
Daylight opening of bottom sash to OM of aluminum 1/2 screen	+ 7"	+ 5 1/4"

FULL SCREEN FOR HISTORICAL WOOD MAGNUM DOUBLE HUNG

Conversion	Width	Height
Daylight opening to OM of aluminum full screen	+ 6 9/16"	x 2 + 8 3/4"

HALF SCREEN FOR HISTORICAL WOOD MAGNUM SINGLE HUNG

Conversion	Width	Height
Daylight opening of bottom sash to OM of aluminum 1/2 screen	+ 6 9/16"	+ 5"

FULL AND 1/3 SCREEN FOR WOOD MAGNUM TRIPLE SASH SINGLE HUNG

Conversion	Width	Height
Daylight opening to OM of aluminum full screen	+ 7"	x 3 + 11 1/16"
Daylight opening of bottom sash to OM of aluminum 1/3 screen	+ 4 1/4"	+ 4 11/16"

FULL SCREEN FOR WOOD MAGNUM TRIPLE HUNG

Conversion	Width	Height
Daylight opening to OM of aluminum full screen	+ 7"	x 3 + 11 1/16"

FULL SCREEN FOR HISTORICAL WOOD MAGNUM TRIPLE HUNG

Conversion	Width	Height
Daylight opening to OM of aluminum full screen	+ 6 9/16"	x 3 + 10 15/16"

ORDERING REPLACEMENT SCREENS CLAD MAGNUM DOUBLE HUNG UNITS

Screens are standard with aluminum surround and charcoal colored fiberglass 18 x 16 screen mesh. Aluminum mesh is available as an option in black, charcoal, bright aluminum or bright bronze. Determine the outside measurement of the existing screen. Surrounds are available in bronze, white, brown and pebble gray.

When ordering replacement screen specify:

1. product and screen type;
2. size; – If there is no existing screen from which to obtain the OM of the screen, determine the size of the screen by using the conversion charts below. The daylight opening is the measurement of the visible glass.
3. color;
4. mesh type (if other than standard).

<p>Full Screen Sizes for Clad Magnum Double Hung manufactured 1989 – Present</p> <p>Daylight Opening to OM of Full Screen</p> <p>Daylight Width + 7 1/16" = OM Width of Screen Daylight Height x 2 + 9 1/16" = OM Height of Screen</p> <p>NOTE: Screens feature plunger type mounting system.</p>		<p>Half Screen Sizes for Clad Magnum Single Hung manufactured 1989 – Present</p> <p>Daylight Opening to OM of Half Screen</p> <p>Daylight Width + 7 1/16" = OM Width of Screen Daylight Height + 5 7/16" = OM Height of Screen</p> <p>NOTE: Screens feature leaf spring and plunger type mounting system.</p>																																
<table border="1" style="width: 100%; border-collapse: collapse;"> <thead> <tr> <th colspan="2" style="text-align: center;">WIDTH</th> <th colspan="2" style="text-align: center;">HEIGHT</th> </tr> <tr> <th style="text-align: center;">SIZE</th> <th style="text-align: center;">OM WIDTH</th> <th style="text-align: center;">SIZE</th> <th style="text-align: center;">OM HEIGHT</th> </tr> </thead> <tbody> <tr> <td>CN 38</td> <td style="text-align: center;">38 1/4"</td> <td>CN 70</td> <td style="text-align: center;">71 1/16"</td> </tr> <tr> <td>CN 42</td> <td style="text-align: center;">42 1/4"</td> <td>CN 78</td> <td style="text-align: center;">79 1/16"</td> </tr> <tr> <td>CN 46</td> <td style="text-align: center;">46 1/4"</td> <td>CN 86</td> <td style="text-align: center;">87 1/16"</td> </tr> <tr> <td>CN 48</td> <td style="text-align: center;">48 1/4"</td> <td>CN 94</td> <td style="text-align: center;">95 1/16"</td> </tr> <tr> <td>CN 50</td> <td style="text-align: center;">50 1/4"</td> <td>CN 102</td> <td style="text-align: center;">103 1/16"</td> </tr> <tr> <td>CN 54</td> <td style="text-align: center;">54 1/4"</td> <td>CN 110</td> <td style="text-align: center;">111 1/16"</td> </tr> </tbody> </table>	WIDTH		HEIGHT		SIZE	OM WIDTH	SIZE	OM HEIGHT	CN 38	38 1/4"	CN 70	71 1/16"	CN 42	42 1/4"	CN 78	79 1/16"	CN 46	46 1/4"	CN 86	87 1/16"	CN 48	48 1/4"	CN 94	95 1/16"	CN 50	50 1/4"	CN 102	103 1/16"	CN 54	54 1/4"	CN 110	111 1/16"	<p>NOTE: There are no standard half screen call numbers established. Order by OM of screen using conversions above.</p>	
WIDTH		HEIGHT																																
SIZE	OM WIDTH	SIZE	OM HEIGHT																															
CN 38	38 1/4"	CN 70	71 1/16"																															
CN 42	42 1/4"	CN 78	79 1/16"																															
CN 46	46 1/4"	CN 86	87 1/16"																															
CN 48	48 1/4"	CN 94	95 1/16"																															
CN 50	50 1/4"	CN 102	103 1/16"																															
CN 54	54 1/4"	CN 110	111 1/16"																															

When ordering replacement parts specify:

1. part number;
2. quantity.

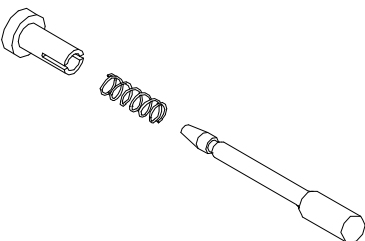



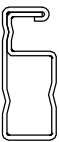


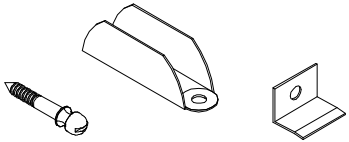
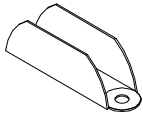
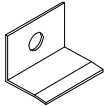
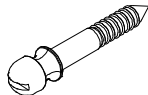

ILLUSTRATION NOT TO SCALE	DESCRIPTION	OPER./COLO R	PART NO.
	<p>Plunger and Spring Assembly M0102 <i>Includes:</i> 1 - Plunger bolt (metal) 1 - Plunger bolt cap (black) 1 - Plunger bolt spring Clad Magnum Double and Single Hung</p>	Black	No longer available
	<p>Screen Mounting Receptacle M111 Clad Magnum Double and Single Hung only</p>	White	05070411
	<p>Spline, Screen V129 Specify lineal feet needed</p>	Black	No longer available
	<p>Corner Key Screen M0121</p>		15225301
	<p>Screen Surround, Aluminum Profile A133 Available in 168" (4267) length</p>	SW BZ PB BN EG	18801100 15231799 15231899 15231699 15231999
	<p>Screen Crossbar, Aluminum Profile A131 Specify OM width of screen</p>	SW BZ PB BN EG	18801080 15233499 15233399 15233299 15233599
	<p>Leaf Spring M0104</p>		11868835

ILLUSTRATION NOT TO SCALE	DESCRIPTION	COLOR	PART NO.
	<p>Screen Hanger Package Includes: 2 – Hangers 11860031 2 – Clips 02570321 2 – Ball drive screws 11011005 4 – #6 x 5/8" Phillips flathead wood screws</p> <p>Magnum wood units only</p>		16010006
	<p>Hanger Includes: 1 – Hanger 1 – #6 x 5/8" Phillips flathead wood screw</p> <p>Magnum Wood units only</p>		11860031
	<p>Clip Includes: 1 – Clip 1 – #6 x 5/8" Phillips flathead wood screw</p> <p>Magnum Wood units only</p>		02570321
	<p>Ball Drive Screw Magnum Wood units only</p>		11011005
	<p>Loop Latch (Bail Loop) Magnum Wood units only</p>		11011006

ORDERING REPLACEMENT ENERGY PANELS FOR MAGNUM UNITS

If you are replacing an existing energy panel, determine the outside measurement of the existing energy panel. If there is no existing energy panel from which to obtain the OM of the panel, determine the size of the energy panel by using the conversion below. The daylight opening is the measurement of the visible glass. Energy panels are available in bronze or stone white aluminum surround (exterior panel).

When ordering energy panels specify:

1. type of unit;
2. size;
3. color of surround;
4. glass type.

**Magnum Double Hung, Single Hung
and Triple Hung****Units manufactured 1984 – Present****Daylight Opening to OM of EP**

Daylight Width + 1 1/8" = OM Width of EP

Daylight Height + 1 1/8" = OM Height of EP

NOTE: OM should not include lip.

MAGNUM DOUBLE HUNG, SINGLE HUNG AND TRIPLE HUNG ENERGY PANELS PARTS

Exterior energy panels are attached with metal turn buttons these can be found in misc mouldings chapter.

When ordering energy panel parts specify:

1. quantity;
2. description;
3. part number.

INTERIOR ENERGY PANELS AND PARTS

ORDERING REPLACEMENT ENERGY PANELS FOR MAGNUM HISTORIC UNITS

If you are replacing an existing energy panel, determine the outside measurement of the existing energy panel. If there is no existing energy panel from which to obtain the OM of the panel, determine the size of the energy panel by using the conversion below. The daylight opening is the measurement of the visible glass. Energy panels are available in a white aluminum surround (interior panel).

When ordering energy panels specify:

1. type of unit;
2. size;
3. glass type.

Magnum Historic Double Hung, Single Hung and Triple Hung

Units manufactured 1986 – Present

Daylight Opening to OM of IEP

Daylight Width + 1 11/16" = OM Width of IEP
 Daylight Height + 1 3/8" = OM Height of IEP

MAGNUM HISTORIC DOUBLE HUNG, SINGLE HUNG AND TRIPLE HUNG ENERGY PANEL PARTS

Interior energy panels are clip mounted.

When ordering energy panel parts specify:

1. quantity;
2. description
3. part number.

ILLUSTRATION <i>NOT TO SCALE</i>	DESCRIPTION	OPER./ COLOR	PART NO.
	Push/Pull Clip, Stainless Steel M755		11100701
	Corner Key, Interior Energy Panel M950		15470016
	Weather strip, Interior Energy Panel M0412 Specify Length	WH	15610097
	Interior Energy Panel Surround, Aluminum Profile A149 For 1/8" glass and 3/16" glass Available in 150" (3810) length Note: Must use V235 for 1/8" glass	WH	18600899
	Spline, Historical Glazing V235 For 1/8" glass only Specify Length	WH	15221211
	Interior Energy Panel Surround, Aluminum Profile A163 For 3/16" featherweight laminated glass Available in 150" (3810) length	WH	18600898

ORDERING REPLACEMENT COMBINATIONS AND/OR INSERTS

Combination units are composed of two glass panels and a screen insert. One of the storm panels slides up for self storage when the screen is in use.

When ordering replacement combinations and/or inserts determine the outside measurement of the existing items or use the following conversions if none exists (based on daylight openings to determine combination size and component sizes). Aluminum surround on combination inserts are available in Bronze and Stone White. Charcoal colored fiberglass mesh screen is standard. Aluminum mesh screen is available as an option.

When ordering replacement combinations specify:

1. size; – If there is no existing combination from which to obtain the OM of the combination, determine the size of the combination by using the conversions below. The daylight opening is the measurement of the visible glass.
2. finish and insert color;
3. mesh type (if other than standard);
4. glass type.

Magnum Combination Units

Wood Magnum Double Hung

Daylight Opening to OM of Combination

Daylight Width + 7 1/16" = OM Width of Combination

Daylight Height x 2 + 9 3/32" = OM Height of Combination

Wood Magnum Historic Double Hung

Daylight Opening to OM of Combination

Daylight Width + 6 5/8" = OM Width of Combination

Daylight Height x 2 + 8 23/32" = OM Height of Combination

Combination Insert

OM of Combination to OM of Stationary Insert

OM Width of Combination - 5 1/8" = OM Width of Stationary Insert

OM Height of Combination - 9 3/32" ÷ 2 = OM Height of Stationary Insert

OM of Combination to OM of Operating Insert

OM Width of Combination - 4 1/2" = OM Width of Operating Insert

OM Height of Combination - 3 17/32" ÷ 2 = OM Height of Operating Insert

OM of Combination to OM of Screen Insert

OM Width of Combination - 5 1/8" = OM Width of Screen Insert

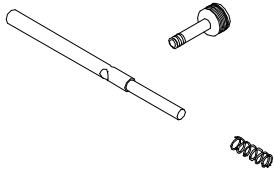


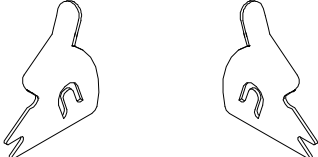
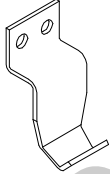
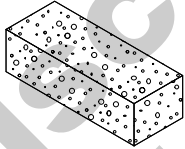
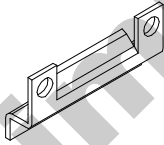

OM Height of Combination - 5 7/32" ÷ 2 = OM Height of Screen Insert

NOTE: Insert height conversions apply only to units with equal sash.

Combination units are composed of two glass panels and a screen insert. One of the storm panels slides up for self storage when the screen is in use. Combinations are attached with turn buttons which can be found in the Miscellaneous Mouldings chapter of the parts manual.

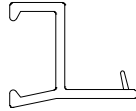
When ordering replacement parts specify:

1. part number;
2. quantity.

ILLUSTRATION NOT TO SCALE	DESCRIPTION	OPER./COLOR	PART NO.
	Knob, Bolt and Spring Assembly <i>Includes:</i> 2 - Aluminum knobs 2 - Combination bolt and spring assemblies		11900521
	Knob, Aluminum For bolt and spring assembly <i>Includes:</i> 2 - Aluminum knobs		11101701
	Knob, Stainless Steel For bolt and spring assembly		03050113
 <p>Left Hand Right Hand</p>	Turn Latch M062 Wood Magnum Double Hung	LH RH	Mill Finish 11860411 11860311
	Hook, Long <i>Includes:</i> 1 - Hook 2 - Rivets (01060758)	Mill Finish	11040100
	Pad, Hook M601 3/8" x 1/2" x 1 5/16"	WH	10500201
	Strike, Stationary Panel M600 <i>Includes:</i> 1 - Strike 2 - Rivets (01060758)	Mill Finish	11040365
	Dual Seal Weather strip, Center Rail V116 Color: White	84" (2134)	15828400

When ordering replacement panel track specify:

1. profile;
2. call number or OM of combination;
3. color;
V057 Black 15222200
V057 White 15222100
4. left, right, top, bottom or complete set.



V057

Operator Panel Track
Vertical and horizontal panels

Discontinued Product
Limited Availability (LA)