

Ultimate Wood Lift & Slide Door

Unit Features.....	1
Abbreviations - Operations - Configurations	2
Standard Divided Lite Option	3
Optional Interior Square Simulated Divided Lite	4
Minimum and Maximum Guidelines	5
Net Clear Openings: Stacked Units.....	6
Net Clear Openings: Pocket Units.....	7
Promoted Sizes and Configurations.....	8
Sill Details: Standard Recessed - Stacked and Pocket Units.....	9
Recessed Sill Slot Depth and Floor Thickness	10
Sill Details: Performance Sill - Stacked and Pocket Units.....	11
Performance Sill Slot Depth and Floor Thickness.....	12
Operating Configurations: Stacked	13
Operating Configurations: Pocket	14
Section Details: Stacked - Short Bottom Rail and Tall Bottom Rail.....	15
Section Details: Pocket - Short Bottom Rail - Uni-Directional	16
Section Details: Pocket - Tall Bottom Rail - Bi-Parting.....	17

Unit Features

NOTE: Ultimate Wood Lift & Slide Door is not available with CE mark.

- Stacked Configurations: All panels are contained within the frame. At least one panel is stationary and bi-parting doors having two stationary panels. When open, operating panels stack over the stationary panels.
- Pocket Configurations: All panels operate with at least one pocket. Bi-parting doors will have two pockets. When opened, all panels are concealed within the pocket.
- All Door units are shipped knocked-down (KD).

Frame:

- Frame components are 1 7/16" (37) thick.
- Frame consists of jamb (s), head jamb, and sill tracks.
- Standard is treated bare pine to the interior. Finger-joint/edge glue for the frame component core with non finger-jointed pine veneer to the interior.
- Alternative wood species include Mahogany and Vertical Grain Douglas Fir.
- Maximum header deflection is 1/8" (3)

Sill:

- Standard sill color is anodized bronze with optional mill anodized available. (Any optional glass-filled ABS components will complement these colors.) Exposed sill track is 3/16" (5) above the finished floor.
- Standard recessed sill is the default and is designed to be installed into a slot in the concrete floor, has incorporated leveling system; and is capable of parallel interlock for multiple tracks. This sill does not have a drainage system.
- Recessed Sill with drainage is designed to be installed into a slot on the concrete floor; has an incorporated leveling system; is capable of parallel interlock for multiple tracks; and has an integral drainage system.
- Flush mounted track: Best used for interior applications and is routed into the floor surface.
- Performance Sill is designed to be installed on a sub-floor or within an open faced slot. The sill has an incorporated leveling system with interlocking tracks to ensure parallelism of multiple tracks. An integral drainage system is worked into the design of the sill. The sill has a nominal height of 2.138" (54).
- Sill must be within 1/32"(.8) level across the entire length

Panel:

- 2 3/4" (70) thick-nominal with doweled fastened corners.
- Available in either Short Bottom Rail or Tall Bottom Rail panel style.
 - Short Bottom Rail: 6" (152) stiles and top rail. 8 1/8" (206) Bottom Rail.
 - Tall Bottom Rail: 4" (102) stiles and top rail. 6" (152) Bottom Rail.
- Stiles and Rails are LVL (laminated veneer lumber) core with non finger-jointed, bare pine veneer on interior. Preservative treated.
- Wood glazing cap is applied to interior with vinyl glazing bead and connecting barb. Standard profile is ogee with option of square.

Hardware:

- Primary panels engage a minimum of two locking points on jambs or bi-parting inactive panel.
- Operating panels use two bogie carrier systems with two rollers which when activated lift panels on to a track allowing movement.
- Maximum panel weight is 660 pounds.
- Handle set: Interior flush mount: Permanently attached to all operating panels along the edge of the stile with a discrete lever which will raise or lower operating panels and engage locking points. Default finish is Bronze PVD, optional Satin Nickel PVD or Polished Brass PVD available.
- Keyed fixed handle an option for primary panel (decrease NCO 4" (102)).
- Exterior finger pull: All doors have exterior finger pulls located on the locking stile of the primary and bi-parting inactive panels. This provides a recessed area to push/pull the primary/bi-parting inactive panel from the exterior as well as an access point to pull panels from the stacked or pocket position.
- Bi-parting doors feature a recessed finger pull, to pull panels from the stacked or pocket positions.
- Optional interior finger pull provides recessed area to push/pull the primary/bi-parting inactive panels.

Glass and Glazing:

- All glass is of select quality complying with ASTM C 1036. Safety glazing per CPSC 16 CFR 1201. Insulating glass is manufactured and tested to pass level ASTM 2190 and is IGCC certified.
 - Glazing Method: Tempered insulated Low E2 Argon in an overall thickness of 7/8" (22)
 - Glazing Seal: Silicone bedding, exterior.
 - Glazing Type: Clear Insulating glass, Low E3 Argon, Low E1 Argon, Low E2/ERS Argon or air, Low E3/ERS Argon or air, Bronze, Gray, Reflective Bronze, Obscure, Laminated, and decorative glass options.
- Glazing will be altitude adjusted for higher elevations, argon gas not included.

Abbreviations - Operations - Configurations**Weather Strip:**

- Default color is bronze/black, optional beige/gray color is available. All units are constructed with vinyl weather strip at the panel perimeter and interlocks. Weather strip exposed to the exterior is UV resistant material.

Abbreviations:

- Ultimate Wood Lift & Slide Door-UWLSD
- Ultimate Wood Lift & Slide Stacked Door-UWLSD STK
- Ultimate Wood Lift & Slide Pocket Door-UWLSD PKT
- Short Bottom Rail Panels - SBR
- Tall Bottom Rail Panels-TBR

Operations

- Door handing is viewed from exterior.
 - P = Pocket
 - X = Operating
 - O = Stationary
 - L = Left handed bi-parting unit
 - R = Right handed bi-parting unit

Examples of operating descriptions:

- 4 panels, moving left into a pocket.
 - PXXXX UWLSD PKT
- 3 panels, two of which move to left for stacking.
 - OXX UWLSD STK
- 6 panels, three moving in each direction to a pocket. The primary panel on the right group of three panels.
 - PXXX-XXXP R UWLSD PKT
- 8 panels, with three moving in each direction for stacking. The primary panel is in the left group of four panels.
 - OXXX-XXXO L UWLSD STK

Configurations:

- Maximum of 4 panels in one direction.
- Maximum of 8 panels for bi-parting units.

Stacked:

- 2 panel door unit OX, XO
- 3 panel door unit OXX, XXO
- 4 panel door unit OXXX, XXXO, OX-XO L or R
- 6 panel door unit OXX-XXO L or R
- 8 panel door unit OXXX-XXXO L or R

Pocket:

- 1 panel door unit PX, XP
- 2 panel door unit PXX, XXP, PX-XP L or R
- 3 panel door unit PXXX, XXXP
- 4 panel door unit PXXXX, XXXXP, PXX-XXP L or R
- 6 panel door unit PXXX-XXXP L or R
- 8 panel door unit PXXXX-XXXXP L or R

Standard Divided Lite Option

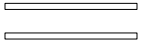

Insulating Glass

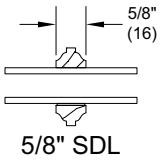

5/8" SDL

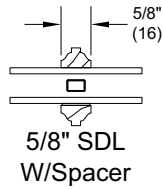

5/8" SDL
W/Spacer

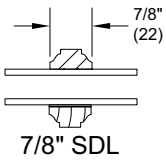

7/8" SDL

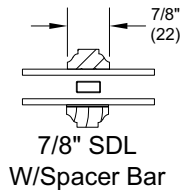

7/8" SDL
W/Spacer Bar

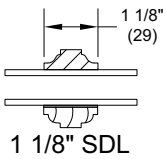

1 1/8" SDL

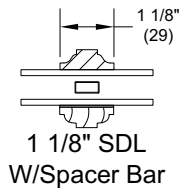

1 1/8" SDL
W/Spacer Bar

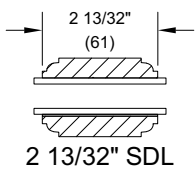

2 13/32" SDL

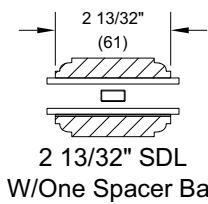

2 13/32" SDL
W/One Spacer Bar

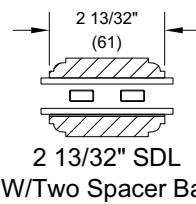

2 13/32" SDL
W/Two Spacer Bar

Optional Interior Square Simulated Divided Lite

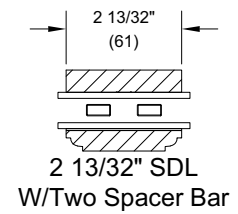
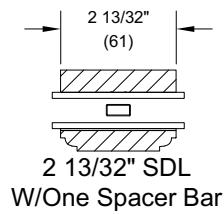
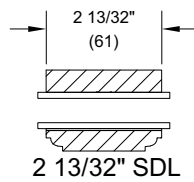
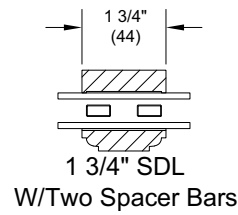
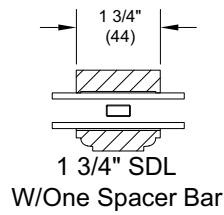
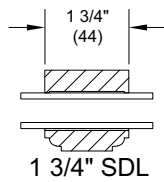
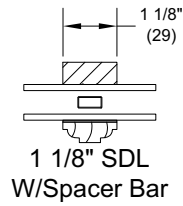
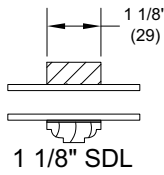
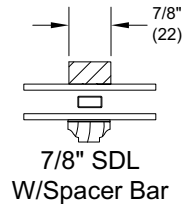
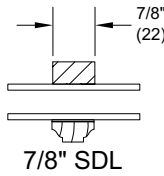
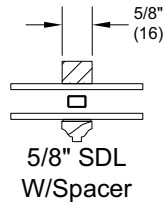
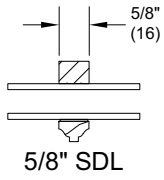

Minimum and Maximum Guidelines

Minimum and Maximum Unit Measurements										
Style/Configuration		Min Frame				Configuration	Max Frame			
		Width		Height			Width		Height	
		ft-in	mm	ft-in	mm		ft-in	mm	ft-in	mm
StackedContemporary*	XO / OX	6-1 23/32	(7218)	7-1 11/32	(3692)	XXXX / OXXX	23-8 3/16	(7218)	12-1 11/32	(3692)
StackedTraditional	XO / OX	5-11 23/32	(7066)	7-1 11/32	(3692)	XXXX / OXXX	23-2 3/16	(7066)	12-1 11/32	(3692)
StackedContemporary*	OX-XO	12-0 3/8	(14359)	7-1 11/32	(3692)	OXXX-XXXX	47-1 5/16	(14359)	12-1 11/32	(3692)
StackedTraditional	OX-XO	11-8 3/8	(14054)	7-1 11/32	(3692)	OXXX-XXXX	46-1 5/16	(14054)	12-1 11/32	(3692)
Pocket Contemporary*	XP / XP	3-3 49/64	(7201)	7-1 11/32	(3692)	XXXXP / PXXXX	23-7 31/64	(7201)	12-1 11/32	(3692)
Pocket Traditional	XP / XP	3-3 49/64	(7048)	7-1 11/32	(3692)	XXXXP / PXXXX	23-1 31/64	(7048)	12-1 11/32	(3692)
Pocket Contemporary*	PX-XP	6-4 15/32	(14323)	7-1 11/32	(3692)	PXXXX-XXXXP	46-11 57/64	(14323)	12-1 11/32	(3692)
Pocket Traditional	PX-XP	6-4 15/32	(14018)	7-1 11/32	(3692)	PXXXX-XXXXP	45-11 57/64	(14018)	12-1 11/32	(3692)

Lift and Slide Minimum and Maximum Panel Size								
Sill Type	Panel Size							
	Min Width		Min Height		Max Width		Max Height	
	in	mm	in	mm	in	mm	in	mm
Flush/Recessed Sill	31	(787)	51	(1295)	73 7/32	(1860)	143	(3632)
Performance Sill	35	(889)						

NOTE: Units with asterisks have a maximum glass size of 60ft² per panel.

Net Clear Openings: Stacked Units

Net Clear Opening Height						
Sill Type		Flushed or Recessed Sill Option		Performance Sill Option		
Unit Height	Call Number	Net Clear Openings		Net Clear Openings		
		ft - in	mm	ft - in	mm	
	7-0	6-10 17/32	(2096)	6-10 33/64	(2096)	
	8-0	7-10 17/32	(2401)	7-10 33/64	(2401)	
	10-0	9-10 17/32	(3011)	9-10 33/64	(3010)	
12-0	11-10 17/32	(3620)	11-10 33/64	(3620)		

Net Clear Opening Width									
Unit Style		Short Bottom Rail (UWLSD STK)				Tall Bottom Rail (UWLSD STK)			
Unit Configuration	Call Number	Net Clear Openings Flush Handle		Net clear Openings Fixed Handle		Net Clear Openings Flush Handle		Net Clear Openings Fixed Handle	
		ft-in	mm	ft-in	mm	ft-in	mm	ft-in	mm
XO or OX	6-0	2-8 3/8	(822)	2-4 9/16	(725)	2-6 3/8	(772)	2-2 9/16	(674)
	8-0	3-8 3/8	(1127)	3-4 9/16	(1030)	3-6 3/8	(1076)	3-2 9/16	(979)
	10-0	4-8 3/8	(1432)	4-4 9/16	(1335)	4-6 3/8	(1381)	4-2 9/16	(1284)
	12-0	5-8 3/8	(1737)	5-4 9/16	(1640)	5-6 3/8	(1686)	5-2 9/16	(1589)
XXO or OXX	9-0	5-5 39/64	(1667)	5-1 51/64	(1569)	5-1 39/64	(1565)	4-9 51/64	(1468)
	12-0	7-5 39/64	(2276)	7-1 51/64	(2179)	7-1 39/64	(2175)	6-9 51/64	(2077)
	15-0	9-5 39/64	(2886)	9-1 51/64	(2789)	9-1 39/64	(2784)	8-9 51/64	(2687)
	18-0	11-5 39/64	(3495)	11-1 51/64	(3398)	11-1 39/64	(3394)	10-9 51/64	(3297)
XXXO or OXXX	12-0	8-2 27/32	(2511)	7-11 1/32	(2414)	7-8 27/32	(2358)	7-5 1/32	(2261)
	16-0	11-2 27/32	(3425)	10-11 1/32	(3328)	10-8 27/32	(3273)	10-5 1/32	(3176)
	20-0	14-2 27/32	(4340)	13-11 1/32	(4242)	13-8 27/32	(4187)	13-5 1/32	(4090)
	24-0	17-2 27/32	(5254)	16-11 1/32	(5157)	16-8 27/32	(5102)	16-5 1/32	(5004)
OX-XO	12-0	5-5 57/64	(1674)	5-2 1/16	(1577)	5-1 57/64	(1572)	4-10 1/16	(1475)
	16-0	7-5 57/64	(2283)	7-2 1/16	(2186)	7-1 57/64	(2182)	6-10 1/16	(2085)
	20-0	9-5 57/64	(2893)	9-2 1/16	(2796)	9-1 57/64	(2791)	8-10 1/16	(2694)
	24-0	11-5 57/64	(3502)	11-2 1/16	(3405)	11-1 57/64	(3401)	10-10 1/16	(3304)
OXX-XXO	18-0	11-0 23/64	(3362)	10-8 17/32	(3265)	10-4 23/64	(3159)	10-0 17/32	(3062)
	24-0	15-0 23/64	(4581)	14-8 17/32	(4484)	14-4 23/64	(4378)	14-0 17/32	(4281)
	30-0	19-0 23/64	(5800)	18-8 17/32	(5703)	18-4 23/64	(5597)	18-0 17/32	(5500)
	36-0	23-0 23/64	(7020)	22-8 17/32	(6922)	22-4 23/64	(6816)	22-0 17/32	(6719)
OXXX-XXXO	24-0	16-6 53/64	(5050)	16-3 1/64	(4953)	15-6 53/64	(4746)	15-3 1/64	(4648)
	32-0	22-6 53/64	(6879)	22-3 1/64	(6782)	21-6 53/64	(6574)	21-3 1/64	(6477)
	40-0	28-6 53/64	(8708)	28-3 1/64	(8611)	27-6 53/64	(8403)	27-3 1/64	(8306)
	48-0	34-6 53/64	(10537)	34-3 1/64	(10440)	33-6 53/64	(10232)	33-3 1/64	(10135)

Net Clear Openings: Pocket Units

Net Clear Opening Height					
Sill Type		Flushed or Recessed Sill Option		Performance Sill Option	
Unit Height	Call Number	Net Clear Openings		Net Clear Openings	
		ft - in	mm	ft - in	mm
	7-0	6-10 17/32	(2096)	6-10 33/64	(2096)
	8-0	7-10 17/32	(2401)	7-10 33/64	(2401)
	10-0	9-10 17/32	(3011)	9-10 33/64	(3010)
12-0	11-10 17/32	(3620)	11-10 33/64	(3620)	

Net Clear Opening Width									
Unit Style		Short Bottom Rail (UWLSD PKT)				Tall Bottom Rail (UWLSD PKT)			
Unit Configuration	Call Number	Net Clear Openings Flush Handle		Net clear Openings Fixed Handle		Net Clear Openings Flush Handle		Net Clear Openings Fixed Handle	
		ft-in	mm	ft-in	mm	ft-in	mm	ft-in	mm
		XP or PX	3-0	3-0 3/32	(917)	2-8 3/32	(815)	3-0 3/32	(917)
4-0	4-0 3/32		(1221)	3-8 3/32	(1120)	4-0 3/32	(1221)	3-8 3/32	(1120)
5-0	5-0 3/32		(1526)	4-8 3/32	(1425)	5-0 3/32	(1526)	4-8 3/32	(1425)
6-0	6-0 3/32		(1831)	5-8 3/32	(1729)	6-0 3/32	(1831)	5-8 3/32	(1729)
XXP or PXX	6-0	5-8 59/64	(1750)	5-5 3/32	(1653)	5-6 59/64	(1700)	5-3 3/32	(1603)
	8-0	7-8 59/64	(2360)	7-5 3/32	(2263)	7-6 59/64	(2309)	7-3 3/32	(2212)
	10-0	9-8 59/64	(2970)	9-5 3/32	(2873)	9-6 59/64	(2919)	9-3 3/32	(2822)
	12-0	11-8 59/64	(3579)	11-5 3/32	(3482)	11-6 59/64	(3528)	11-3 3/32	(3431)
XXXXP or PXXXX	9-0	8-6 5/32	(2595)	8-2 21/64	(2498)	8-2 5/32	(2493)	7-10 21/64	(2396)
	12-0	11-6 5/32	(3509)	11-2 21/64	(3412)	11-2 5/32	(3407)	10-10 21/64	(3310)
	15-0	14-6 5/32	(4423)	14-2 21/64	(4326)	14-2 5/32	(4322)	13-10 21/64	(4225)
	18-0	17-6 5/32	(5338)	17-2 21/64	(5241)	17-2 5/32	(5236)	16-10 21/64	(5139)
XXXXP or PXXXX	12-0	11-3 25/64	(3439)	10-11 9/16	(3342)	10-9 7/16	(3288)	10-5 9/16	(3189)
	16-0	15-3 25/64	(4658)	14-11 9/16	(4561)	14-9 7/16	(4507)	14-5 9/16	(4409)
	20-0	19-3 3/8	(5877)	18-11 9/16	(5780)	18-9 7/16	(5726)	18-5 9/16	(5628)
	24-0	23-3 25/64	(7096)	22-11 9/16	(6999)	22-9 7/16	(6945)	22-5 9/16	(6847)
PX-XP	6-0	6-0 43/64	(1846)	5-8 43/64	(1744)	6-0 43/64	(1846)	5-8 43/64	(1744)
	8-0	8-0 43/64	(2456)	7-8 43/64	(2354)	8-0 43/64	(2456)	7-8 43/64	(2354)
	10-0	10-0 43/64	(3065)	9-8 43/64	(2964)	10-0 43/64	(3065)	9-8 43/64	(2964)
	12-0	12-0 43/64	(3675)	11-8 43/64	(3573)	12-0 43/64	(3675)	11-8 43/64	(3573)
PXX-XXP	18-0	11-6 31/32	(3530)	11-3 9/64	(3433)	11-2 31/32	(3428)	10-11 9/64	(3331)
	24-0	15-6 31/32	(4749)	15-3 9/64	(4652)	15-2 31/32	(4647)	14-11 9/64	(4550)
	30-0	19-6 31/32	(5968)	19-3 9/64	(5871)	19-2 31/32	(5867)	18-11 9/64	(5769)
	36-0	23-6 31/32	(7187)	23-3 9/64	(7090)	23-2 31/32	(7086)	22-11 9/64	(6989)
PXXX-XXXP	18-0	17-1 7/16	(5218)	16-9 39/64	(5121)	16-5 7/16	(5015)	16-1 39/64	(4918)
	24-0	23-1 7/16	(7047)	22-9 39/64	(6950)	22-5 7/16	(6844)	22-1 39/64	(6747)
	30-0	29-1 7/16	(8876)	28-9 39/64	(8779)	28-5 7/16	(8673)	28-1 39/64	(8575)
	36-0	35-1 7/16	(10705)	34-9 39/64	(10607)	34-5 7/16	(10501)	34-1 39/64	(10404)
PXXXX-XXXXP	24-0	22-7 29/32	(6906)	22-4 5/64	(6809)	21-7 29/32	(6602)	21-4 5/64	(6505)
	32-0	30-7 29/32	(9345)	30-4 5/64	(9248)	29-7 29/32	(9040)	29-4 5/64	(8943)
	40-0	38-7 29/32	(11783)	38-4 5/64	(11686)	37-7 29/32	(11478)	37-4 5/64	(11381)
	48-0	46-7 29/32	(14222)	46-4 5/64	(14125)	45-7 29/32	(13917)	45-4 5/64	(13820)

Promoted Sizes and Configurations

Stacked Units					
Promoted Sizes and Configurations					
Based on: 3/0, 4/0, 5/0, 6/0 Panel Widths					
7/0, 8/0, 10/0 Panel Heights					
2W	3W	4W	4W	6W	8W
OX / XO	OXX / XXO	OXXX / XXXO	OX - XO L or R	OXX - XXO L or R	OXXX - XXXO L or R
6070	9070	12070	12070	18070	24070
8070	12070	16070	16070	24070	32070
10070	15070	20070	20070	30070	40070
12070	18070	24070	24070	36070	48070
6080	9080	12080	12080	18080	24080
8080	12080	16080	16080	24080	32080
10080	15080	20080	20080	30080	40080
12080	18080	24080	24080	36080	48080
60100	90100	120100	120100	180100	240100
80100	120100	160100	160100	240100	320100
100100	150100	200100	200100	300100	400100
120100	180100	240100	240100	360100	480100

Pocket Units							
Promoted Sizes and Configurations							
Based on: 3/0, 4/0, 5/0, 6/0 Panel Widths							
7/0, 8/0, 10/0 Panel Heights							
1 Pocket 1 Panel	1 Pocket 2 Panel	1 Pocket 3 Panel	1 Pocket 4 Panel	2 Pocket 2 Panel	2 Pocket 4 Panel	2 Pocket 6 Panel	2 Pocket 8 Panel
PX / XP	PXX / XXP	PXXX / XXXP	PXXXX / XXXXP	PX / XP	PXX / XXP	PXXX / XXXP	PXXXX / XXXXP
3070	6070	9070	12070	6070	12070	18070	24070
4070	8070	12070	16070	8070	16070	24070	32070
5070	10070	15070	20070	10070	20070	30070	40070
6070	12070	18070	24070	12070	24070	36070	48070
3080	6080	9080	12080	6080	12080	18080	24080
4080	8080	12080	16080	8080	16080	24080	32080
5080	10080	15080	20080	10080	20080	30080	40080
6080	12080	18080	24080	12080	24080	36080	48080
30100	60100	90100	120100	60100	120100	180100	240100
40100	80100	120100	160100	80100	160100	240100	320100
50100	100100	150100	200100	100100	200100	300100	400100
60100	120100	180100	240100	120100	240100	360100	480100

Sill Details: Standard Recessed - Stacked and Pocket Units

Scale: Not to Scale

Description of Measurements Used

- L. **Total RO Height:** Is from the bottom of the slot to 1/2" (13) above the header jamb height.
- M. **Rough Opening Height:** For Recessed/Flush: Sub Floor surface to 1/2" (13) above the header jamb height.
- N. **Frame Height:** For Recessed/Flush: Top of finished floor to top of header jamb.
- O. **System OM Height:** Distance from the bottom of the sill to top of head jamb.
- S. **Net Clear Opening Height:** The shortest measurement from the top of sill track to bottom surface of header guide.

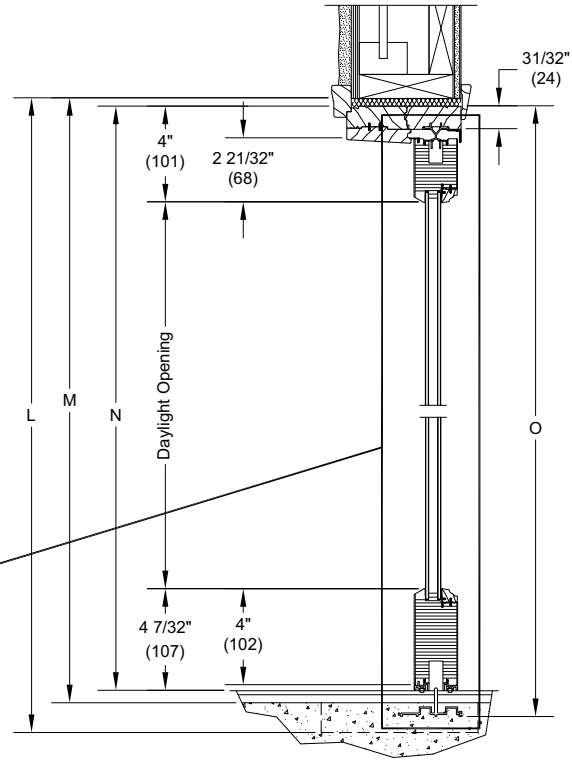
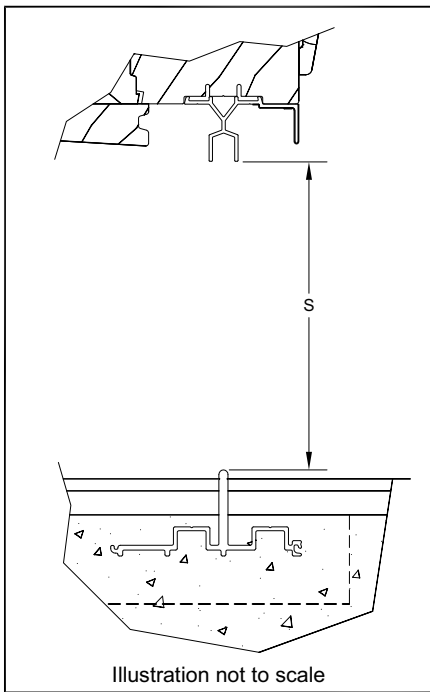

Standard Recessed Sill

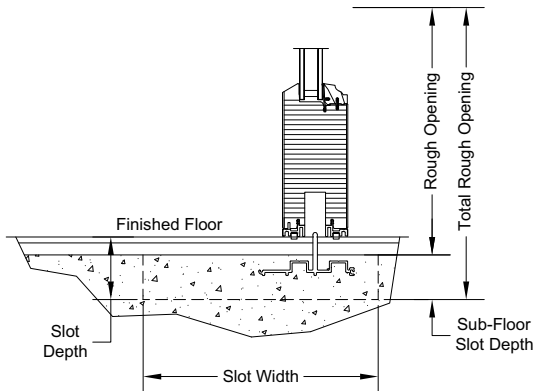

Recessed Sill with Drainage

A weep system within the sill allows water which migrates over the sill or through the interlocks to exit to the exterior.

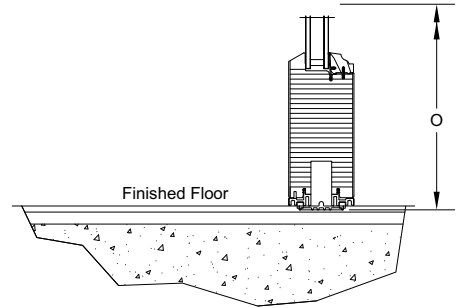

Flush Mount Sill

Best for interior applications, the base of this sill is routed into the finished floor to a point that the track is exposed 3/16" (5) above finished floor.

Recessed Sill Slot Depth and Floor Thickness

Slot Depth Chart

Recessed and Recessed with Drainage Sill Slot Depth Chart				
Number of Tracks	Pocket Slot Depth		Stacked Slot Depth	
	in	mm	in	mm
1	6	(152)	5	(127)
2	9 13/16	(249)	8 13/16	(224)
3	13 5/8	(346)	12 5/8	(321)
4	17 1/2	(445)	16 1/2	(419)

Field Calculations:

Slot Width = System Width + 2" (51)

Sub-floor Slot Recess = 2 5/8" (67) - Finished Floor Thickness

Floor Thickness

Recessed and Recessed with Drainage Sill			
Finished Floor Thickness		Slot Depth	
0	(00)	2 5/8	(67)
1/8	(03)	2 1/2	(64)
1/4	(06)	2 3/8	(60)
3/8	(10)	2 1/4	(57)
1/2	(13)	2 1/8	(54)
5/8	(16)	2	(51)
3/4	(19)	1 7/8	(48)
7/8	(22)	1 3/4	(44)
1	(25)	1 5/8	(41)

Sill Details: Performance Sill - Stacked and Pocket Units

Scale: Not to Scale

Description of Measurements used

- L. **Total RO Height:** Is from the bottom of the slot (or sub-floor) to 1/2" (13) above the header jamb.
- M. **Rough Opening Height:** From the sub floor surface to 1/2" (13) above the header jamb.
- N. **Frame Height:** Top of sill cover to top of header jamb.
- O. **System OM Height:** Distance from the bottom of the sill to top of head jamb.

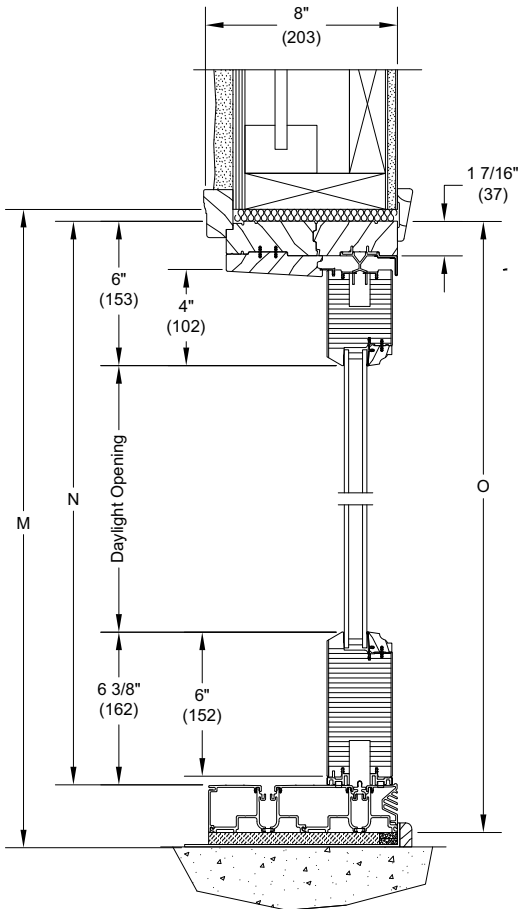

Performance Sill w/ Subfloor

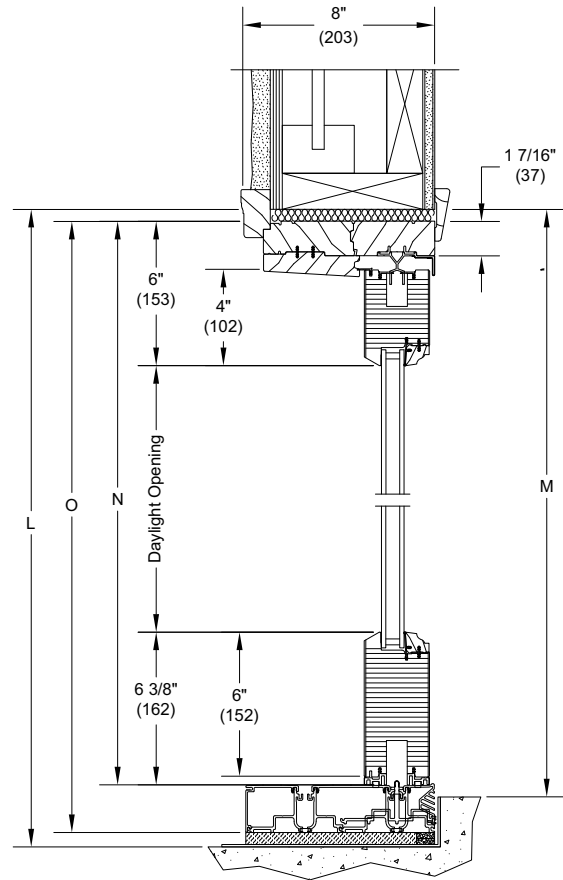

Performance Sill w/ Open Slot

Performance Sill Slot Depth and Floor Thickness

Open Face Slot Depth Chart

Open Face Slot Depth		
Number of Tracks	Slot Depth (minimum)	
	in	mm
1	4 5/16	(110)
2	8 1/8	(206)
3	11 15/16	(303)
4	15 13/16	(402)

Floor Thickness

Performance Sill with Sub-Floor Slot Recess and Open Face			
Available Floor Thickness		Sub-Floor Slot Recess	
in	mm	in	mm
0	(00)	2 3/8	(60)
1/4	(06)	2 1/8	(54)
1/2	(13)	1 7/8	(48)
3/4	(19)	1 5/8	(41)
1	(25)	1 3/8	(35)
1 1/4	(32)	1 1/8	(29)
1 1/2	(38)	7/8	(22)
1 3/4	(44)	5/8	(16)
2	(51)	3/8	(10)

Operating Configurations: Stacked

Scale: Not to Scale

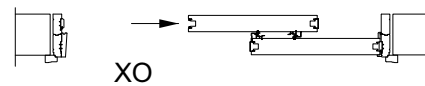
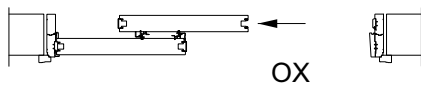
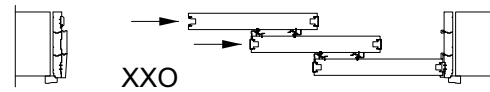
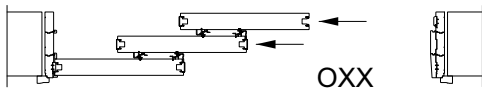
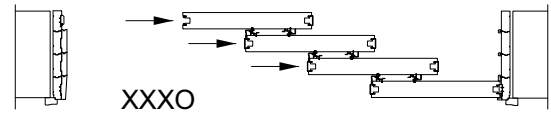
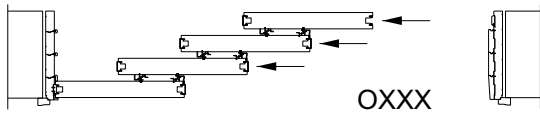

Jamb Depths Minimums for Stacked:
(jamb depths vary dependent upon operating configuration)

- 2 panel - 6 27/32" (173)
- 3 panel - 10 21/32" (271)
- 4 panel - 14 1/2" (368)

Operating Configurations: Pocket

Scale: Not to Scale

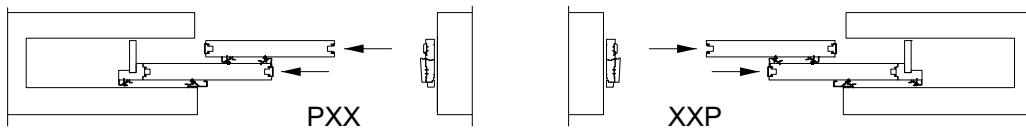
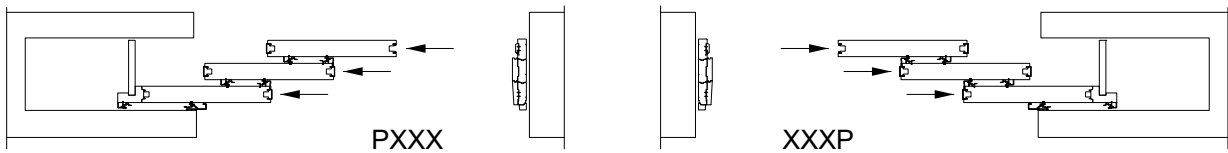
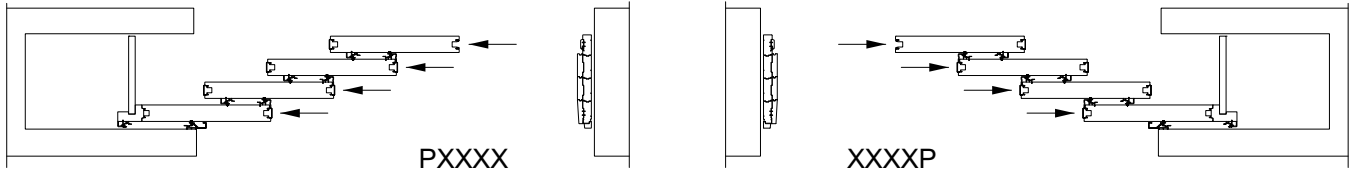
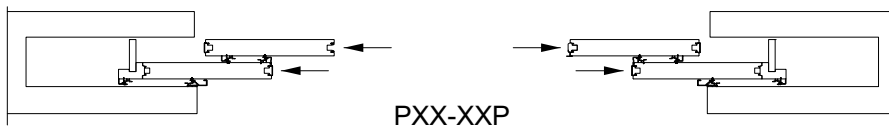
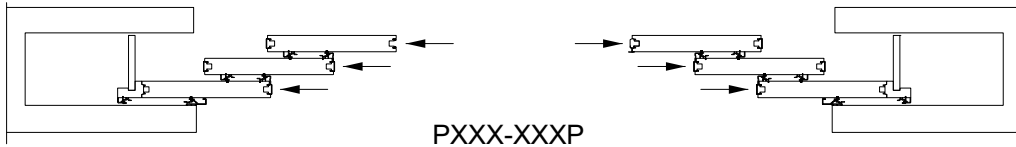
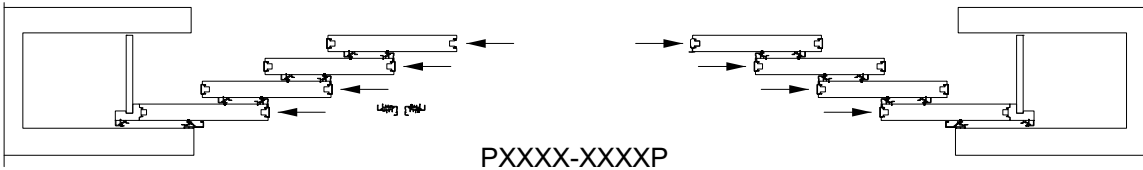

Number of Panels	Jamb Depth Minimums for Pocket		Pocket Depth	
	in	mm	in	mm
1 panel	4 1/8	(105)	4 1/2	(114)
2 panel	7 31/32	(202)	8 1/4	(210)
3 panel	11 25/32	(299)	12 1/8	(308)
4 panel	15 19/32	(396)	15 15/16	(405)

NOTE: Jamb depths vary dependent upon operating configuration.

Section Details: Stacked - Short Bottom Rail and Tall Bottom Rail

Scale: Not to Scale

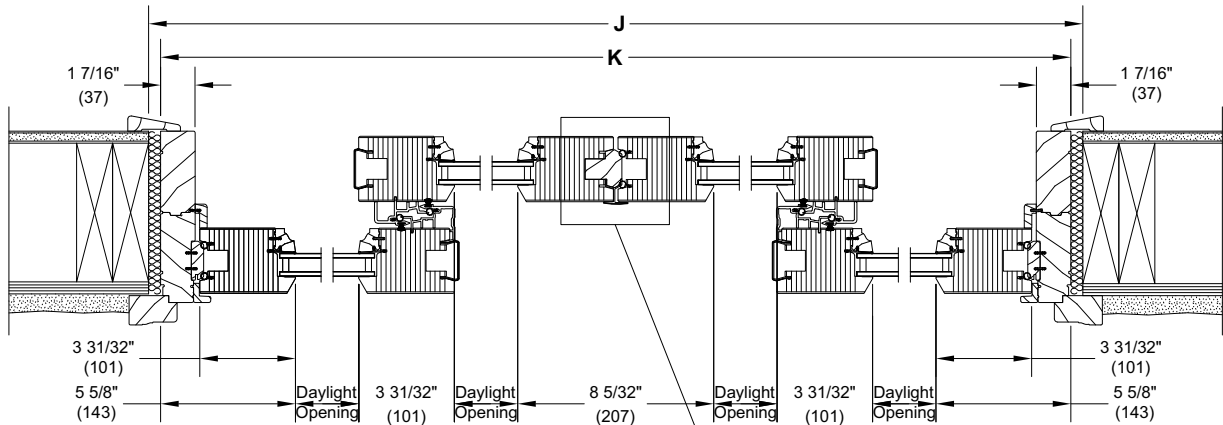

**UWLSD STK - Short Bottom Rail
Bi-Parting OX-XO**

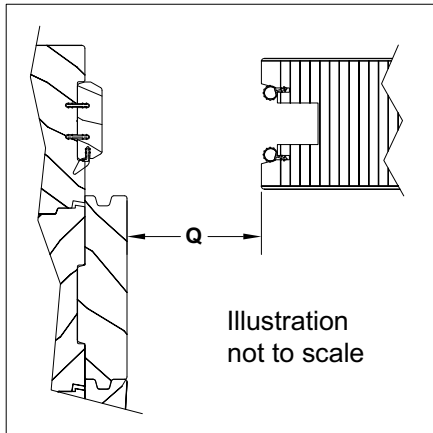
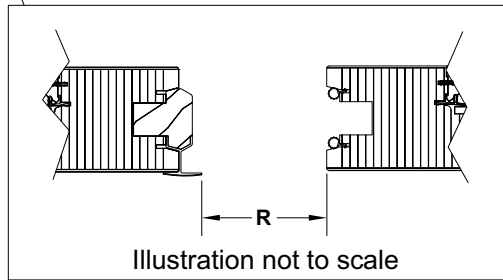

Description of Measurements Used:

- J. Rough Opening Width:** 1" (25) wider than OM of frame.
- K. Frame OSM Width:** OM of jamb to OM of jamb.
- R. Bi-Parting-Net Clear Opening Width:** The shortest measurement from the surface of the panel edge to the surface of the astragal.
- Q. Uni-directional-Net Clear Opening Width:** The shortest measurement from the surface of the part stop to the surface of the panel edge.

**UWLSD STK - Tall Bottom Rail
Uni-Directional - XXO**

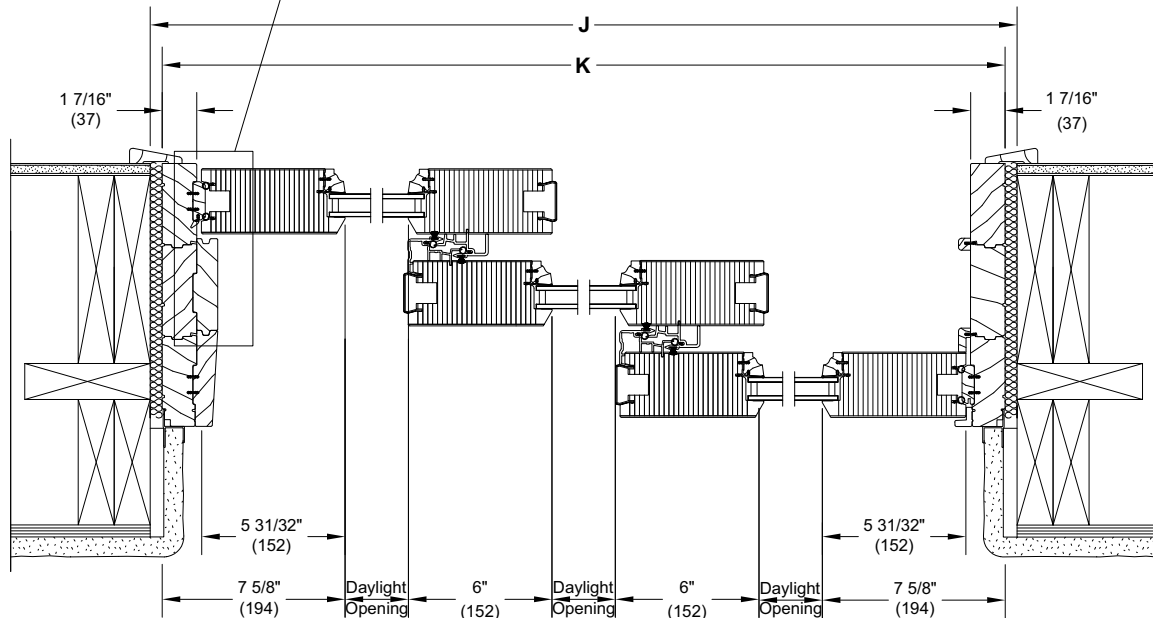

Section Details: Pocket - Short Bottom Rail - Uni-Directional

Scale: Not to Scale

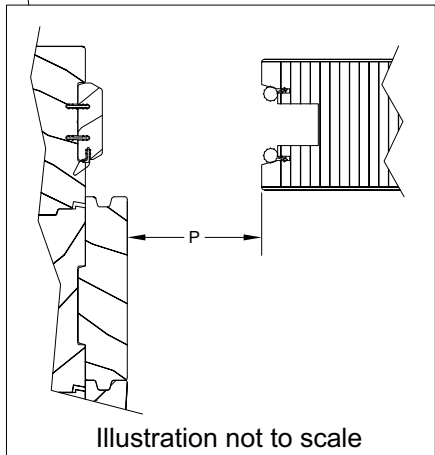
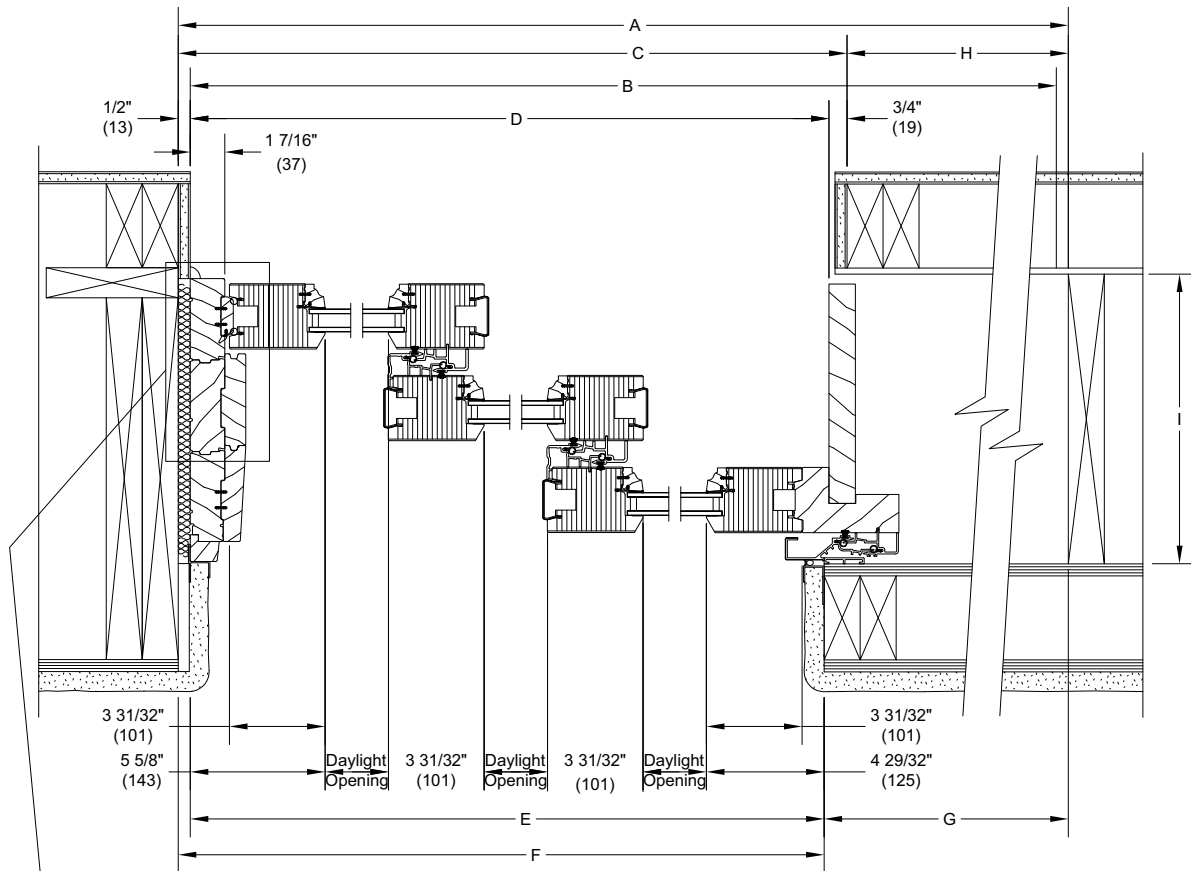

**UWLSD PKT Short Bottom Rail
XXXP**

Description of Measurements Used:

- A. **Total RO Width:** Is 3" (76) wider than System OM
- B. **System OM Width:** Recessed/Flush Sill: length of header jamb.
Performance Sill: 2" (51) wider than length of header jamb.
- C. **Interior RO Width** To the interior plane of the door and is 1 1/4" (32) wider than the interior frame width.
- D. **Interior Frame Width:** Interior surface of pocket cover to OM of jamb.
- E. **Exterior Frame Width:** Pocket interlock base to OM of jamb.
- F. **Exterior RO Width:** Pocket interlock base to 1/2" (13) to beyond jamb.
- G. **Exterior Pocket Width:** Pocket interlock base to Total Rough Opening.
- H. **Interior Pocket Width:** Exterior Pocket minus 15/16" (24)
- I. **Pocket Depth:** Is measured from the pocket interlock base attachment to the interior surface of the pony wall.
- P. **Net Clear Opening Width:** The shortest measurement from the surface of the part stop to the surface of the panel edge.

Section Details: Pocket - Tall Bottom Rail - Bi-Parting

Scale: Not to Scale

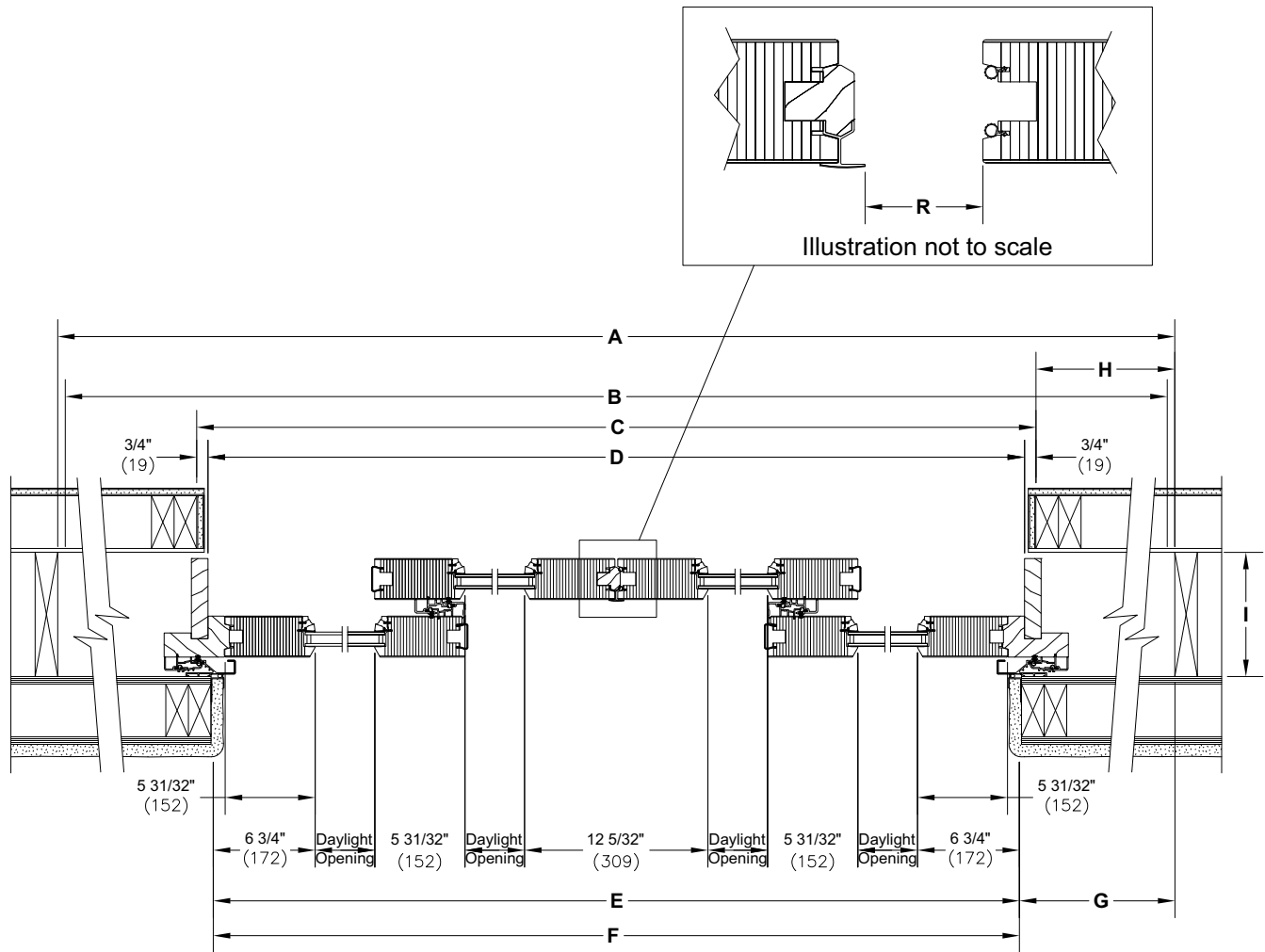

**UWLSD PKT Tall Bottom Rail
PXX - XXP**

Description of Measurements Used:

- A. **Total RO Width:** Is 5" (127) wider than header jamb.
- B. **System OM Width:** Recessed/Flush Sill: Length of Header jamb. Performance Sill: 4" (101) wider than length of head jamb.
- C. **Interior RO Width** To the interior plane of the door and is 1 1/2" (38) wider than the interior frame width.
- D. **Interior Frame Width:** Interior surface of pocket cover to interior surface of pocket cover.
- E. **Exterior Frame Width:** Pocket interlock base to pocket interlock base.
- F. **Exterior RO Width:** Pocket interlock base to pocket interlock base.
- G. **Exterior Pocket Width:** Pocket interlock base to Total Rough Opening.
- H. **Interior Pocket Width:** Exterior Pocket width minus 15/16" (24).
- I. **Pocket Depth:** Is measured from the pocket interlock base attachment to the interior surface of the pony wall.
- R. **Net Clear Opening Width:** The shortest measurement from the surface of the panel edge to the surface of the astragal.