







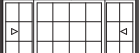
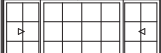
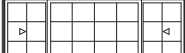
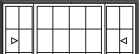
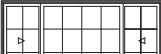
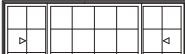

## 1 Wide XOX Operator Units

<b>MO (mm)</b>	6-0 (1829)	7-0 (2134)	8-0 (2438)
<b>RO (mm)</b>	6-0 1/2 (1842)	7-0 1/2 (2146)	8-0 1/2 (2451)
<b>FS (mm)</b>	5-11 1/2 (1816)	6-11 1/2 (2121)	7-11 1/2 (2426)

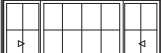
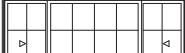
2-0 (610) 2-0 1/4 (616) 1-11 3/4 (603)	 ITGLTS7224	 ITGLTS8424	 ITGLTS9624
3-0 (914) 3-0 1/4 (921) 2-11 3/4 (908)	 ITGLTS7236	 ITGLTS8436	 ITGLTS9636
3-6 (1067) 3-6 1/4 (1073) 3-5 3/4 (1060)	 ITGLTS7242	 ITGLTS8442	 ITGLTS9642
4-0 (1219) 4-0 1/4 (1226) 3-11 3/4 (1213)	 ITGLTS7248	 ITGLTS8448	 ITGLTS9648 E
5-0 (1524) 5-0 1/4 (1530) 4-11 3/4 (1518)	 ITGLTS7260	 ITGLTS8460	 ITGLTS9660 E

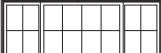
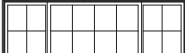
## Construction Details

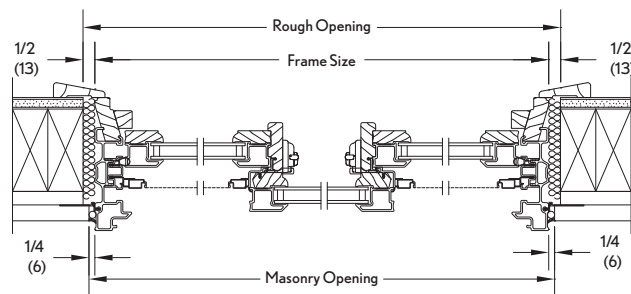

Triple Sash XOX Operator Jamb

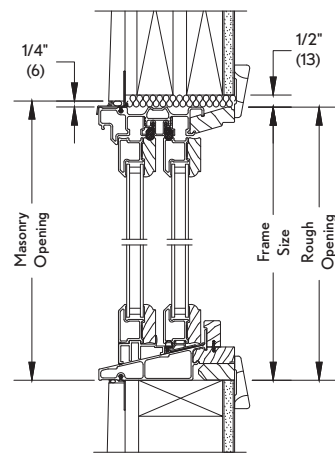

Head Jamb and Sill