

ELEVATE GLIDER

Table of Contents

	PAGE
History	2
Part Identification – Operator	3
Part Identification – Triple Sash	4
Hardware	5
Miscellaneous	7
Weather Strip and Vinyl	9
Wood Parts	16
Sash Replacement	17
Grille Replacement	18
Screens and Screen Parts	19
Discontinued – Limited Availability (LA) – Weather Strip and Vinyl	20
Discontinued – Limited Availability (LA) – Wood Parts	21
Discontinued – No Availability (NA) – Hardware	22
Discontinued – No Availability (NA) – Weather Strip and Vinyl	23

ATTENTION:

- Specification and technical data are subject to change without notice.
- Numbers listed in parentheses () are metric equivalents in millimeters rounded to the nearest whole number.

PRODUCED	UNIT TYPE	FEATURES OR CHANGES	DISCONTINUED
January 2006	Glider	Redesigned product introduction featuring more wood to the interior, sloped sills, new hardware and meeting stile interlocks.	Present
July 2006	Glider	SDL offered on all Elevate Series windows and doors. 7/8" wide bars with Ultrex exterior and wood interior. See Product Bulletin 66 for more details.	Present
September 2006	Glider	Prairie SDL and GBG Lite cuts made available for the Elevate series windows and doors. See Product Bulletin 70 for more details.	Present
March 2007	Glider	Bronze exteriors introduced.	Present
November 2007	Glider	Evergreen exteriors introduced.	Present
March 2008	Glider	Cashmere exteriors introduced March 17, 2008.	Present
July 2008	Glider	Cottage SDL lite cut made available for Elevate. Refer to product bulletin #99.	Present
October 2008	Glider	Introduced Brass, Satin Nickel and Oil Rubbed Bronze hardware finishes for windows.	Present
May 2009	Glider	LoE ³ 366™ glass option introduced.	Present
January 2010	Glider	Introduced new grille tack and installation tool and added to accessory chapter.	Present
February 2010	Glider	Sill cover changed from W8793 to W10682.	Present
April 2010	Glider	Tempered Obscure glass option introduced.	Present
December 2011	Glider Triple Sash	Introduced Elevate special sizes and through jamb installation option. Added 72 and 84 CN to ELGLTS.	Present
June 2012	Glider	Simulated Checkrail Bar option introduced.	Present
August 2012	Glider	August 27, 2012: Introduced Elevate Ebony exterior and exterior casing options.	Present
December 2014	Glider	Updated Jamb Carrier Assembly and Frame Weather Strip V938 to V2505	Present
August 2016	Glider	Discontinued Jamb Jack	Present
September 2017	Glider	Discontinued Stationary Sash Head Jamb Bracket	Present
December 2017	Glider	Added availability of customer specified lite cut configurations for SDL with and without spacer bar and GBG. To include simulated check rail and allow any color GBG to the exterior only of standard and special sized units.	Present
2018	Glider	October 29, 2018 – Introduced Designer Black and Clear interior finishes and Matte Black (MBK) hardware option. Low E3 ERS glass type was added.	Present
December 2018	Glider	December 17, 2018: Introduced textured glass types: Reed, Narrow Reed, Rain, Glue Chip and Frost and also colored glass types: Clear, Bronze, Gray and Green.	Present

HEAD JAMB AND SILL DETAIL

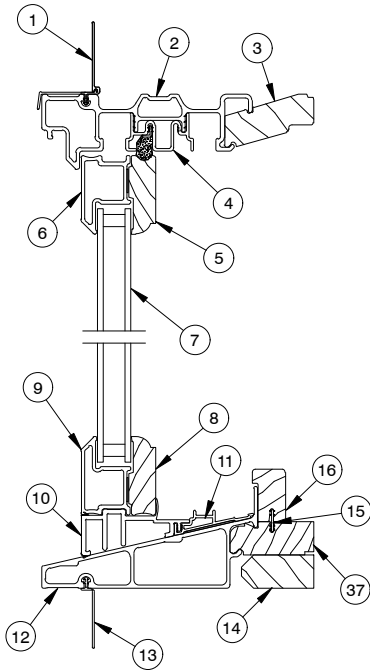

**Head Jamb and Sill
Stationary**

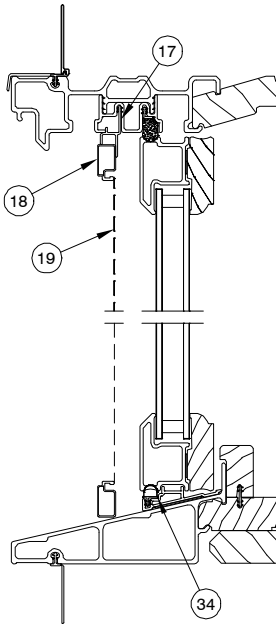

**Head Jamb and Sill
Operator**

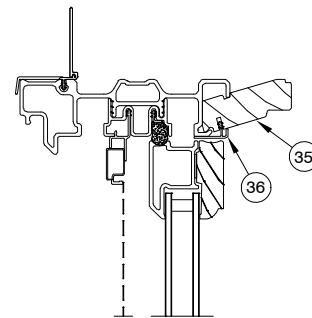

**Head Jamb
Interior Painted
Units Only**

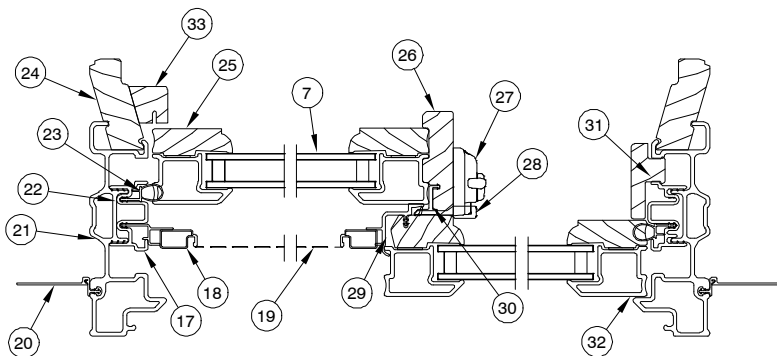

JAMB DETAIL

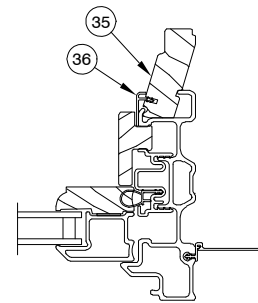

**Jamb
Interior Painted
Units Only**

- 1. Nailing Fin/Drip Cap
- 2. Head Jamb (Ultrex)
- 3. Head Jamb Liner
- 4. Head Jamb Carrier
- 5. Top Rail
- 6. Top Rail Cladding (Ultrex)
- 7. Insulating Glass
- 8. Bottom Rail
- 9. Bottom Rail (Ultrex)
- 10. Sill Filler
- 11. Sill Track
- 12. Sill (Ultrex)

- 13. Sill Nailing Fin
- 14. Sill Filler Block
- 15. Connecting Barb
- 16. Sill Cover
- 17. Screen Track
- 18. Screen Frame
- 19. Screen Mesh
- 20. Jamb Nailing Fin
- 21. Jamb Cladding (Ultrex)
- 22. Jamb Carrier
- 23. Jamb Weather Strip
- 24. Jamb Liner

- 25. Stile
- 26. Meeting Stile Cover
- 27. Sash Lock
- 28. Sash Keeper
- 29. Meeting Stile Weather Strip/Screen Channel
- 30. Vinyl Interlock
- 31. Wood Interior Stop
- 32. Stile Cladding (Ultrex)
- 33. Trim Piece
- 34. Sill Weather Strip
- 35. Head Jamb/Jamb Liner with Kerf
- 36. Interior Jamb Cover
- 37. Sill Liner

**GLIDER TRIPLE SASH
XOX OPERATION**

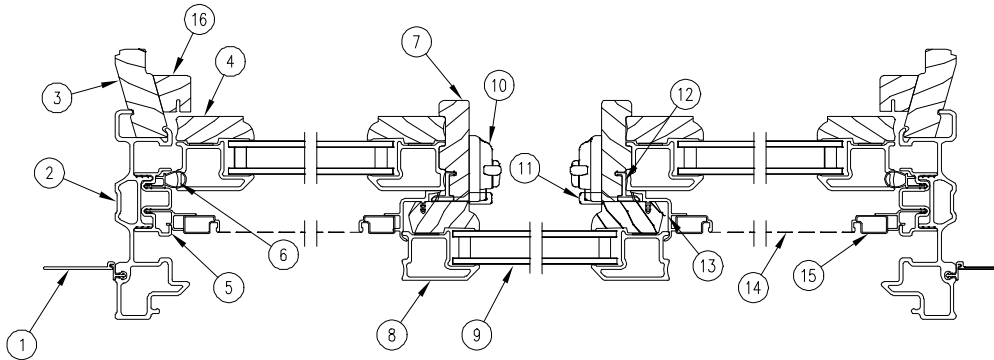

- | | |
|-------------------------|--|
| 1. Nailing Fin/Drip Cap | 9. Insulating Glass |
| 2. Jamb (Ultrex) | 10. Sash Lock |
| 3. Jamb Liner | 11. Sash Keeper |
| 4. Stile | 12. Meeting Stile Weather Strip and Screen Channel |
| 5. Jamb Carrier | 13. Screen Track |
| 6. Frame Weather Strip | 14. Screen Mesh |
| 7. Meeting Stile Cover | 15. Screen Frame |
| 8. Stile (Ultrex) | 16. Interior Trim |

NOTE: Not to scale; specifications subject to change without notice.

When ordering replacement Integrity Glider parts specify:

1. Type of unit;
2. Part number;
3. Description.

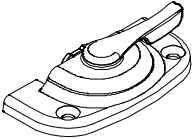

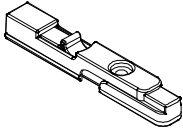
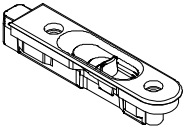
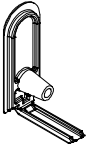
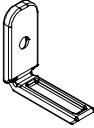
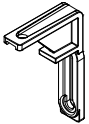

ILLUSTRATION <i>NOT TO SCALE</i>	DESCRIPTION	OPER./COLOR	PART NO.
	<p>Cam Lock <i>Uses 2 EA recommended fasteners: #6 x 1 1/2" Phillips flat head screws AF(11800341), WH (11800340) ORBZ (11800344), SN (11800343) BS (11800342), MB (11800348)</i></p>	<p>LH/OX Almond Frost White Oil Rubbed Bronze Satin Nickel Bright Brass Matte Black</p> <p>RH/XO Almond Frost White Oil Rubbed Bronze Satin Nickel Bright Brass Matte Black</p>	<p>10150056 10150054 10150096 10150094 10150092 10150098</p> <p>10150055 10150053 10150095 10150093 10150091 10150097</p>
	<p>Keeper <i>Uses 2 EA recommended fasteners: #6 x 1 1/2" Phillips flat head screws AF(11800341), WH (11800340) ORBZ (11800344), SN (11800343) BS (11800342), MB (11800348)</i></p>	<p>Almond Frost White Oil Rubbed Bronze Satin Nickel Bright Brass Matte Black</p>	<p>10840046 10840045 10840049 10840048 10840047 10840050</p>
	<p>Top Tilt Latch <i>Includes fasteners: 1 - #7 x 1 1/4" Phillips pan head screw</i></p>	<p>Beige</p>	<p>11869708</p>
	<p>Tilt Latch, Bottom Sash <i>Uses 2 EA recommended fasteners: 1 - #7 x 1 1/4" Phillips pan head screw AF(11807161), WH (11807160), ORBZ (11807165), SN (11807164) BS (11807163), BK (11807169)</i></p>	<p>Almond Frost White Oil Rubbed Bronze Satin Nickel Bright Brass Black</p>	<p>11869707 11869705 11869753 11869752 11869751 11869709</p>
	<p>Meeting Stile Glide <i>Uses 1 EA recommended fasteners: 1 - #7 x 1 1/4" Phillips pan head screw AF(11807161), WH (11807160), ORBZ (11807165), SN (11807164) BS (11807163), BK (11807169)</i></p>	<p>Almond Frost White Oil Rubbed Bronze Satin Nickel Bright Brass Black</p>	<p>11040330 11040331 11040339 11040338 11040337 11040333</p>
	<p>Jamb Stile Glide <i>includes: 1 - #7 x 3/4" Phillips pan head screw</i></p>	<p>Beige</p>	<p>11040332</p>
	<p>Stationary Sash Head Jamb Bracket</p>	<p>Beige</p>	<p>11862557</p>

ILLUSTRATION <i>NOT TO SCALE</i>	DESCRIPTION	OPER./COLOR	PART NO.
	<p>Operator Sash Peg <i>includes:</i> 1 – #8 x3/4 " screw</p>	Beige	11897211
	<p>Operator Sash Peg for Units Over 48 inches with two cam locks <i>includes:</i> 2 – #8 x3/4 " screws</p>	Beige	11897212

When ordering replacement Integrity Glider parts specify:

1. Type of unit;
2. Part number;
3. Description.

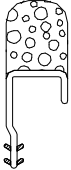
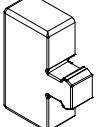
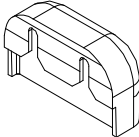

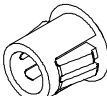
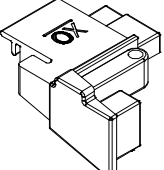
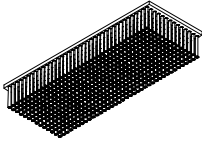

ILLUSTRATION <i>NOT TO SCALE</i>	DESCRIPTION	OPER./COLOR	PART NO.
	<p>Sash Stop – Header V1530</p> <p style="text-align: right;">3/4" (19) 3/4" (19) 3/4" (19)</p> <p style="text-align: right;">96" (2438) 96" (2438) 96" (2438)</p>	<p>Beige Black White</p> <p>Beige Black White</p>	<p>11870201 11870301 11870401</p> <p>11870299 11870399 11870499</p>
	<p>Sash Stop – Bottom</p>	<p>Beige Black White</p>	<p>11870140 11870142 11870141</p>
	<p>Sash Stop – Triple Sash</p>	<p>Beige Black White</p>	<p>118651 118654 118650</p>
	<p>Jamb Hole Plug</p>	<p>Beige</p>	<p>11882968</p>
	<p>Through Jamb Plug</p>	<p>Beige Black Stone White</p>	<p>11882969 11882971 11882970</p>
	<p>Meeting Stile Plug</p>	<p>XO Stone White Pebble Bronze Evergreen Cashmere Black</p> <p>OX Stone White Pebble Bronze Evergreen Cashmere Black</p>	<p>10500196 10500198 10500194 10500323 10500329 10500324</p> <p>10500197 10500199 10500193 10500322 10500328 10500332</p>

ILLUSTRATION <i>NOT TO SCALE</i>	DESCRIPTION	OPER./COLOR	PART NO.
	<p>Head Jamb Dust Block <i>Adhesive backed</i></p>	<p>Gray</p>	<p>15608563</p>
	<p>Keeper Dust Block <i>Adhesive backed</i></p>	<p>Gray</p>	<p>156598</p>
	<p>Meeting Stile Dust Block <i>Adhesive backed</i></p>	<p>Gray</p>	<p>11867907</p>

When ordering replacement Integrity Glider parts specify:

1. Type of unit;
2. Part number;
3. Description.



ILLUSTRATION <i>NOT TO SCALE</i>	DESCRIPTION	LENGTH	PART NO.		
	Frame Weather Strip – Head Jamb, ELGL V2510		Beige	Black	White
	CN36	16 21/32" (423)	17013736	18013736	19013736
	CN48	22 21/32" (575)	17013748	18013748	19013748
	CN60	28 21/32" (728)	17013760	18013760	19013760
	CN72	34 21/32" (880)	17013772	18013772	19013772
	Frame Weather Strip – Head Jamb, ELGLTS – Operator V2510		Beige	Black	White
	CN72	16 21/32" (423)	17013736	18013736	19013736
	CN84	19 21/32" (499)	17013742	18013742	19013742
	CN96	22 21/32" (575)	17013748	18013748	19013748
	Frame Weather Strip – Head Jamb, ELGLTS – Stationary V2510		Beige	Black	White
	CN72	36 13/32" (925)	17013737	18013737	19013737
	CN84	44 13/32" (1128)	17013784	18013784	19013784
CN96	48 13/32" (1229)	17013796	18013796	19013796	
Lineal	100" (2540)	17013800	18013800	19013800	
	Frame Weather Strip – Jamb V1474		Beige	Black	White
CN24	21 3/4" (552)	17006024	17066024	17076024	
CN36	33 3/4" (857)	17006036	17066036	17076036	
CN42	39 3/4" (1010)	17006042	17066042	17076042	
CN48	45 3/4" (1162)	17006048	17066048	17076048	
CN60	57 3/4" (1467)	17006060	17066060	17076060	
Lineal	96" (2438)	17030099	17040099	17050099	
	Frame Weather Strip – Sill, ELGL V1143		Beige	Black	White
CN36	16 9/16" (421)	17000536	17030536	17020536	
CN48	22 9/16" (573)	17000548	17030548	17020548	
CN60	28 9/16" (726)	17000560	17030560	17020560	
CN72	34 9/16" (878)	17000572	17030572	17020572	
Frame Weather Strip – Sill, ELGLTS V1143		Beige	Black	White	
CN72	16 9/16" (421)	17000536	17030536	17020536	
CN84	19 9/16" (497)	17000584	17030584	17020584	
CN96	22 9/16" (573)	17000548	17030548	17020548	

ILLUSTRATION <i>NOT TO SCALE</i>	DESCRIPTION	LENGTH	PART NO.			
	Screen Track Head Jamb - ELGL V1413 CN36 CN48 CN60 CN72	 15 7/8" (403) 21 7/8" (556) 27 7/8" (708) 33 7/8" (860)	Beige 17011936 17011948 17011960 17011972	Black 17055736 17055748 17055760 17055772	White 17055636 17055648 17055660 17055672	
	Screen Track Head Jamb - ELGLTS V1413 CN72 CN84 CN96	 15 7/8" (403) 18 7/8" (479) 21 7/8" (556)	Beige 17011936 17011942 17011948	Black 17055736 17055742 17055748	White 17055636 17055642 17055648	
	Screen Track - Jamb V1413 CN24 CN36 CN42 CN48 CN60	 21 1/2" (546) 33 1/2" (851) 39 1/2" (1003) 45 1/2" (1156) 57 1/2" (1461)	Beige 17011824 17011836 17011842 17011848 17011860	Black 17044724 17044736 17044742 17044748 17044760	White 17044624 17044636 17044642 17044648 17044660	
	 <p data-bbox="147 1098 358 1199"><i>includes: Sill track 1" adhesive tape to underside</i></p>	Sill Track V1425 CN36 CN48 CN60 CN72 CN84 CN96	 33 1/8" (841) 45 1/8" (1146) 57 1/8" (1451) 69 1/8" (1756) 81 1/8" (2061) 93 1/8" (2365)	Beige 17011536 17011548 17011560 17011572 17011584 17011596	Black 17055536 17055548 17055560 17055572 17055584 17055596	White 17066536 17066548 17066560 17066572 17066584 17066596

V1392 Usage: BG 2/26/2018 – present Usage BK and WH 10/29/2018 – present				Sill Filler ELGL				
Size		Ext. Color	Part No. (Interior Substrate/Operation)					
			Beige OX	Beige XO	Black OX	Black XO	White OX	White XO
16 7/8" (429)	CN36	Stone White	17011636	17011637	17110336	17110337	17110636	17110637
		Cashmere	17012138	17012139	17110436	17110437	17110736	17110737
		Pebble	17011736	17011737	17110536	17110537	17110836	17110837
		Bronze	17011838	17011839	15990336	15990337	15993036	15993037
		Evergreen	17011938	17011939	15990436	15990437	15993136	15993137
		Ebony	17012338	17012339	15990536	15990537	15993236	15993237
		Stone White	17011648	17011649	17110348	17110349	17110648	17110649
Cashmere	17012150	17012151	17110448	17110449	17110748	17110749		
Pebble	17011748	17011749	17110548	17110549	17110848	17110849		
Bronze	17011850	17011851	15990348	15990349	15993048	15993049		
Evergreen	17011950	17011951	15990448	15990449	15993448	15993449		
Ebony	17012350	17012351	15990548	15990549	15993548	15993549		
28 7/8" (783)	CN60	Stone White	17011660	17011661	17110360	17110361	17110660	17110661
		Cashmere	17012162	17012163	17110460	17110461	17110760	17110761
		Pebble	17011760	17011761	17110560	17110561	17110860	17110861
		Bronze	17011862	17011863	15990360	15990361	15993360	15993361
		Evergreen	17011962	17011963	15990460	15990461	15993460	15993461
		Ebony	17012362	17012363	15990560	15990561	15993560	15993561
		Stone White	17011672	17011673	17110371	17110372	17110672	17110673
Cashmere	17012171	17012173	17110472	17110473	17110772	17110773		
Pebble	17011772	17011773	17110572	17110573	17110872	17110873		
Bronze	17011872	17011873	15990372	15990373	15993372	15993373		
Evergreen	17011971	17011973	15990472	15990473	15993472	15993473		
Ebony	17012371	17012373	15990572	15990573	15993572	15993573		

Sill Filler ELGLTS  V1392 Usage: Beige – 2/26/2018 – present Black and White – 10/29/2018 – present	Size		Ext. Color	Part No. (Interior Substrate)		
				Beige	Black	White
	36 11/16" (932)	CN72	Stone White	17011671	17011271	17033271
			Cashmere	17012170	17011371	17033371
			Pebble	17011771	17011471	17033471
			Bronze	17011871	15990372	15930072
			Evergreen	17011970	15990472	15930172
			Ebony	17012071	15990572	15930272
	42 11/16" (1084)	CN84	Stone White	17011684	17011284	17033284
			Cashmere	17012184	17011384	17033384
Pebble			17011784	17011484	17033484	
Bronze			17011884	15990384	15930084	
Evergreen			17011984	15990484	15930184	
Ebony	17012084	15990584	15930284			
48 11/16" (1237)	CN96	Stone White	17011696	17011296	17033296	
		Cashmere	17012196	17011396	17033396	
		Pebble	17011796	17011496	17033496	
		Bronze	17011896	15990396	15930096	
		Evergreen	17011996	15990496	15930196	
Ebony	17012096	15990596	15930296			

Screen Track - Meeting Stile
V1412

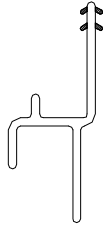
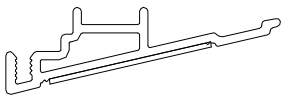
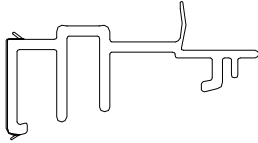
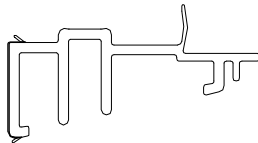
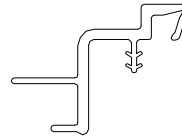

Size		Part No.					
		Beige OX	Beige XO	Black OX	Black XO	White OX	White XO
21 17/32" (547)	CN24	17011424	17011425	19011424	19011425	18011424	18011425
33 17/32" (852)	CN36	17011436	17011437	19011436	19011437	18011436	18011437
39 17/32" (1004)	CN42	17011442	17011443	19011442	19011443	18011442	18011443
45 17/32" (1157)	CN48	17011448	17011449	19011448	19011449	18011448	18011449
57 17/32" (1461)	CN60	17011460	17011461	19011460	19011461	18011460	18011461

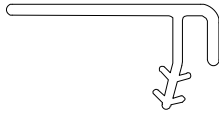
V2955				A: Interior Jamb Cap B: Interior Head Jamb Cap		
Size			Designer Black - LH	Designer Black - RH	White - LH	White - RH
A	20 27/32" (530)	CN24	15608523	15608524	15609523	15609524
	32 27/32" (834)	CN36	15608535	15608536	15609535	15609536
	38 27/32" (987)	CN42	15608541	15608542	15609541	15609542
	44 27/32" (1139)	CN48	15608547	15608548	15609547	15609548
	56 27/32" (1444)	CN60	15608559	15608560	15609559	15609560
Size			Designer Black		White	
B	33 23/32" (856)	CN36	15608537		15609537	
	45 23/32" (1161)	CN48	15608549		15609549	
	57 23/32" (1466)	CN60	15608561		15609561	
	69 23/32" (1771)	CN72	15608573		15609573	
	81 23/32" (2076)	CN84	15608584		15609584	
	93 23/32" (2380)	CN96	15608596		15609596	

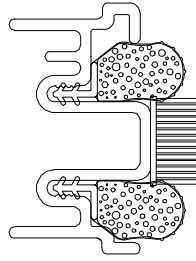

A: Head Jamb Carrier Assembly, ELGL

B: Head Jamb Carrier Assembly, ELGLTS

includes:
V1327 Vinyl jamb carrier
V2510 Frame weather strip
Checkrail fuzzy

A	Size		BG - XO	BG - OX	BK - XO	BK - OX	WH - XO	WH - OX
		32 7/8" (835)	CN36	17370736	17370737	18371736	18371737	19371736
	44 7/8" (1140)	CN48	17370748	17370749	18371748	18371749	19371748	19371749
	56 7/8" (1445)	CN60	17370760	17370761	18371760	18371761	19371760	19371761
	68 7/8" (1749)	CN72	17370772	17370773	18371772	18371773	19371772	19371773

B	Size		BG - XO	BK - XO	WH - XO
		68 7/8" (1749)	CN72	17370771	18371771
	80 7/8" (2054)	CN84	17370784	18371784	19371784
	92 7/8" (2359)	CN96	17370796	18371796	19371796

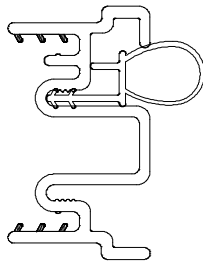

C: Jamb Carrier Assembly – Operator

C: Jamb Carrier Assembly – Stationary

includes:
V1327 Vinyl jamb carrier
V1474 Head jamb weather strip

C	Size Operator Side		Beige OX - LH	Beige XO - RH	Black OX - LH	Black XO - RH	White OX - LH	White XO - RH
		21 31/32" (558)	CN24	17370325	17370324	18370325	18370324	19370325
	33 31/32" (863)	CN36	17370337	17370336	18370337	18370336	19370337	19370336
	39 31/32" (1015)	CN42	17370343	17370342	18370343	18370342	19370343	19370342
	45 31/32" (1168)	CN48	17370349	17370348	18370349	18370348	19370349	19370348
	57 31/32" (1472)	CN60	17370361	17370360	18370361	18370360	19370361	19370360

C	Size Stationary Side		Beige LH	Beige RH
		21 31/32" (558)	CN24	17370025
	33 31/32" (863)	CN36	17370037	17370036
	39 31/32" (1015)	CN42	17370443	17370442
	45 31/32" (1168)	CN48	17370049	17370048
	57 31/32" (1472)	CN60	17370061	17370060

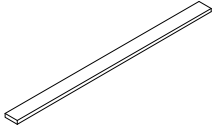
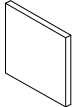
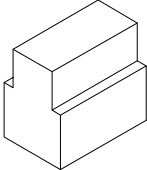
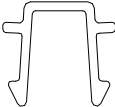
ILLUSTRATION <i>NOT TO SCALE</i>	DESCRIPTION	LENGTH/COLOR	PART NO.
	<p>Foam Tape, 1/4" x 1/8" Frame to Sash Seal</p>	<p>50' Roll Gray</p>	<p>11406228</p>
	<p>Lower Jamb Hole Seal</p>	<p>Beige</p>	<p>10500111</p>
	<p>Balance Tube Channel Block <i>Use a quantity of one per operator jamb.</i></p>	<p>Beige</p>	<p>10501053</p>
	<p>Stationary Clip</p>	<p>Beige</p>	<p>10893001</p>

TO ORDER REPLACEMENT WOOD PARTS

When ordering replacement wood parts specify:

1. Profile number;
2. Part number;
3. Length;
4. Handing (if applicable);
5. Bare wood or white interior;
6. Quantity.

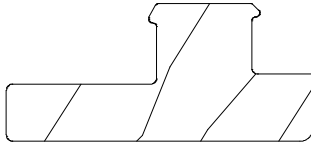
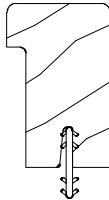
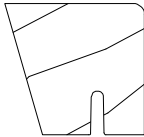
<p>A: Interior Stop</p>  <p>W8936</p>	<p>B: Sill Cover Kit</p>  <p>W10682 – Sill Cover includes V803 Connecting Barb</p>	<p>C: Interior Trim</p>  <p>W9365</p> <p><i>NOTE: W9365 part length is for products produced 02/22/2010 – present.</i></p>
---	--	--

		Size		Bare Wood	White	Designer Black	Clear
A		20 15/32" (519)	CN24	31516124	39216124	39936124	39216124
		32 15/32" (824)	CN36	31516136	39216136	39936136	39216136
		38 15/32" (977)	CN42	31516142	39216142	39936142	39216142
		44 15/32" (1130)	CN48	31516148	39216148	39936148	39216148
		56 15/32" (1434)	CN60	31516160	39216160	39936160	39216160
B		33 15/16" (862)	CN36	11896944	11896949	11897086	11897085
		45 15/16" (1166)	CN48	11896945	11896950	11897088	11897087
		57 15/16" (1471)	CN60	11896946	11897013	11897090	11897089
		69 15/16" (1776)	CN72	11896947	11897015	11897092	11897091
		81 15/16" (2081)	CN84	11896943	11897030	11897094	11897093
		93 15/16" (2386)	CN96	11896948	11897017	11897096	11897095
C				XO	XO	XO	XO
		20 31/64" (520)	CN24	31517724	39217724	39229724	31617724
		32 31/64" (825)	CN36	31517736	39217736	39229736	31617736
		38 31/64" (977)	CN42	31517742	39217742	39229742	31617742
		44 31/64" (1130)	CN48	31517748	39217748	39229748	31617748
		56 31/64" (1435)	CN60	31517760	39217760	39229760	31617760
				OX	OX	OX	OX
		20 31/64" (520)	CN24	31517725	39217725	39229725	31617725
		32 31/64" (825)	CN36	31517737	39217737	39229737	31617737
		38 31/64" (977)	CN42	31517743	39217743	39229743	31617743
		44 31/64" (1130)	CN48	31517749	39217749	39229749	31617749
		56 31/64" (1435)	CN60	31517761	39217761	39229761	31617761

ORDERING GLIDER REPLACEMENT SASH

When ordering replacement sash specify:

1. Size (call number or OM of sash)
2. Operating, stationary or picture
3. Stone White, Pebble Gray, Bronze, Evergreen, Cashmere, or Ebony exterior
4. Glazing
5. Bare wood, White, Designer Black or Clear interior.

Sash Sizes for Glider manufactured January 2006 to Present Daylight Opening to OM of Sash			
Daylight Width + 3 1/4" = OM Width of Sash			
Daylight Height + 3 1/4" = OM Height of Sash			
<i>NOTE: Glider sash is not reglazable</i>			
<i>Replacement sash includes hardware and weather strip.</i>			
<i>Replacement picture sash includes sill filler and weather strip.</i>			
Operator and Stationary Sash – ELGL and ELGLTS			
Width		Height	
Size	OM Width	Size	OM Height
EIGL			
CN 36	16 15/16" (430)	CN 24	20 15/16" (532)
CN 48	22 15/16" (583)	CN 36	32 15/16" (837)
CN 60	28 15/16" (735)	CN 42	38 15/16" (989)
CN 72	34 15/16" (888)	CN 48	44 15/16" (1142)
ELGLTS			
CN 72(Stationary)	36 15/16" (938)	CN 60	56 15/16" (1446)
CN 72(Operator)	16 15/16" (430)		
CN 84(Stationary)	42 15/16" (1091)		
CN 84(Operator)	19 15/16" (507)		
CN 96 (Stationary)	48 15/16" (1243)		
CN 96 (Operator)	22 15/16" (583)		

GLIDER

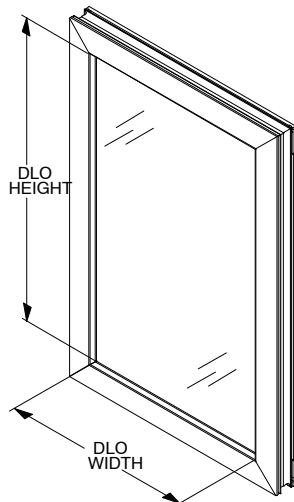

NOTE: The daylight opening is the measurement of visible glass.

EXTERIOR VIEW

ORDERING REPLACEMENT GRILLES

When ordering replacement grilles specify:

1. Call number (using chart below)
2. Bare wood, White, Designer Black, or Clear.

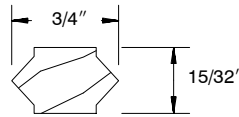

W7340

GRILLE END PROFILE

GRILLE INFORMATION							
WIDTH				HEIGHT			
CN	SASH OM	DLO	GRILLE CUT	CN	SASH OM	DLO	GRILLE CUT
ELGL	16 15/16" (430)	13 11/16" (348)	2W	CN24	21 3/16" (532)	17 11/16" (449)	2H
CN36							
CN48	22 15/16" (583)	19 11/16" (500)	2W	CN36	33 3/16" (837)	29 11/16" (754)	3H
CN60	28 15/16" (735)	25 11/16" (652)	3W	CN42	39 3/16" (989)	35 11/16" (906)	3H
CN72	39 15/16" (888)	31 11/16" (805)	3W	CN48	45 3/16" (1142)	41 11/16" (1059)	3H
ELGLTS	36 15/16" (938)	33 11/16" (856)	4W	CN60	57 3/16" (1446)	53 11/16" (1364)	4H
CN72 (Stationary)							
CN72 (Operator)	16 15/16" (430)	13 11/16" (348)	2W				
CN72 (Stationary)	42 15/16" (1091)	39 11/16" (1008)	4W				
CN72 (Operator)	19 15/16" (507)	16 11/16" (424)	2W				
CN96 (Stationary)	48 15/16" (1243)	45 11/16" (1160)	4W				
CN96 (Operator)	22 15/16" (583)	20 11/16" (500)	2W				

ORDERING REPLACEMENT SCREENS FOR INTEGRITY GLIDER

Screens are standard with a color matched aluminum surround and charcoal colored fiberglass 18 x 16 screen mesh. Determine the outside measurement of the existing screen. Find the sizes that correspond to the width and height indicated on the following chart.

When ordering replacement screen specify:

1. Size; – if there is no existing screen from which to obtain the OM of the screen, determine the size of the screen by using the conversion chart below. The daylight opening is the measurement of the visible glass;
2. Color –Stone White, Pebble Gray, Bronze, Evergreen, Cashmere or Ebony.

Screen Sizes for Elevate Glider manufactured January 2006 to present			
Daylight Opening to OM of Screen			
Daylight Width + 1 13/16" (46) = OM Width of Screen			
Daylight Height + 3 9/16" (90) = OM Height of Screen			
NOTE: Screen feature plunger type mounting system.			
Width		Height	
Size	OM Width	Size	OM Height
ELGL			
CN 36	15 1/2" (394)	CN 24	21 1/4" (540)
CN 48	21 1/2" (546)	CN 36	33 1/4" (845)
CN 60	27 1/2" (699)	CN 42	39 1/4" (997)
CN 72	33 1/2" (851)	CN 48	45 1/4" (1149)
ELGLTS			
CN 72	15 1/2" (394)	CN 60	57 1/4" (1454)
CN 84	18 1/2" (470)		
CN 96	21 1/2" (546)		

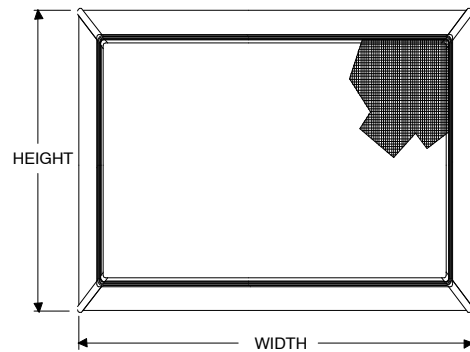

NOTE: OM of screen includes corner keys.

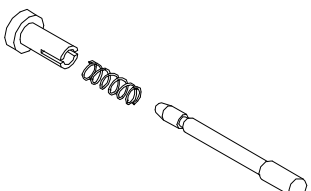
ILLUSTRATION NOT TO SCALE	DESCRIPTION	COLOR	PART NO.
	Plunger and Spring Assembly M060 Includes: 1 - Plunger bolt 1 - Plunger bolt cap 1 - Plunger bolt spring	Clear Cap Off White Bolt	11900896

When ordering replacement Integrity Glider parts specify:

1. Description;
2. Profile number;
3. Part number;
4. Quantity.

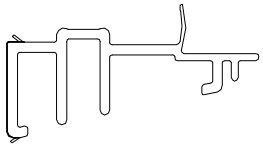
ILLUSTRATION <i>NOT TO SCALE</i>	DESCRIPTION	LENGTH	PART NUMBER	
	<p>Sill Filler V1392 <i>Usage: Prior to 2/26/2018</i></p> <p>ELGL</p> <p>CN36 – Ebony CN48 – Ebony CN60 – Ebony CN72 – Ebony</p>	<p>16 7/8" (429) 22 7/8" (581) 28 7/8" (734) 34 7/8" (886)</p>	<p>OX</p> <p>17012238 17012250 17012262 17012271</p>	<p>XO</p> <p>17012239 17012251 17012263 17012273</p>
	<p>ELGLTS</p> <p>CN72 – Ebony CN84 – Ebony C96 – Ebony</p>	<p>36 11/16" (932) 42 11/16" (1084) 48 11/16" (1237)</p>	<p>XOX</p> <p>17012271 17012284 17012296</p>	

When ordering replacement Wood parts specify:

1. Profile number
2. Part number;
3. Length number;
4. Quantity.
5. Bare wood or white interior

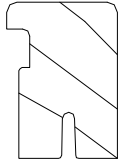
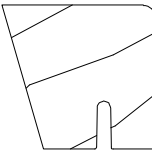
ILLUSTRATION <i>NOT TO SCALE</i>	DESCRIPTION	LENGTH	BARE WOOD PART NO.	WHITE INTERIOR PART NO.
	Sill Cover W8793			
	CN36	33 15/16" (862)	31509236	39209236
	CN48	45 15/16" (1166)	31509248	39209248
	CN60	57 15/16" (1471)	31509260	39209260
	CN72	69 15/16" (1776)	31509272	39209272
	CN96	93 15/16" (2386)	31509296	39209296
 <p data-bbox="185 1035 396 1056">W9365 – Interior Trim</p> <p data-bbox="168 1104 431 1182"><i>NOTE: Part length is for products produced prior to 02/22/2010.</i></p>	Interior Trim W9365 <i>Usage: Prior to 02/22/2010</i>		XO	XO
	CN24	20 5/8" (524)	31517824	39217824
	CN36	32 5/8" (829)	31517836	39217836
	CN42	38 5/8" (981)	31517842	39217842
	CN48	44 5/8" (1134)	31517848	39217848
	CN60	56 5/8" (1438)	31517860	39217860
			OX	OX
	CN24	20 5/8" (524)	31517825	39217825
	CN36	32 5/8" (829)	31517837	39217837
	CN42	38 5/8" (981)	31517843	39217843
	CN48	44 5/8" (1134)	31517849	39217849
	CN60	56 5/8" (1438)	31517861	39217861

When ordering replacement parts specify:

1. Type of unit;
2. Part number;
3. Description.

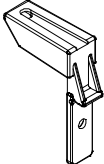
ILLUSTRATION <i>NOT TO SCALE</i>	DESCRIPTION	OPER./COLOR	PART NO.
	Jamb Hole Plug		Discontinued replace with 11882968
	Stationary Head Jamb Bracket	Beige	Discontinued Replace with 11862557

When ordering replacement Integrity Glider parts specify:

1. Description;
2. Profile number;
3. Part number;
4. Quantity.

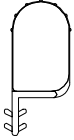
ILLUSTRATION <i>NOT TO SCALE</i>	DESCRIPTION	LENGTH	PART NUMBER
	Frame Weather Strip V2505 Usage: 8/2014–7/2015		Discontinued replace with V2510