

ELEVATE DOUBLE HUNG

Table of Contents

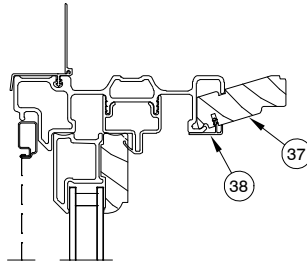
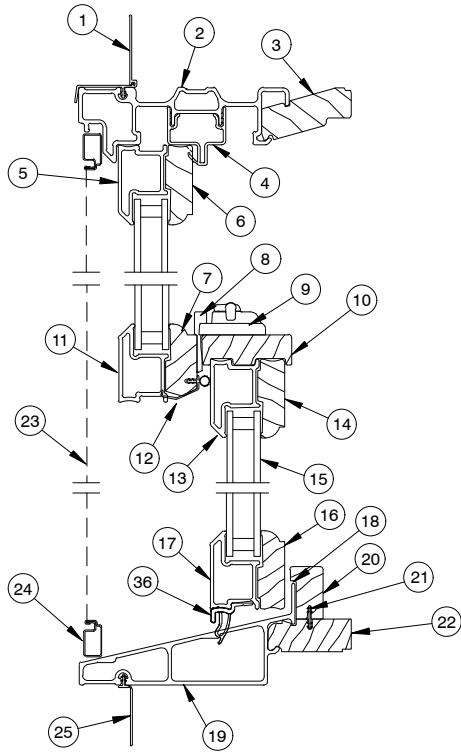
	PAGE
History	2
Part Identification – Operator	3
Part Identification – Stationary/Picture	4
Parts	
Hardware	5
Miscellaneous Parts	7
Weather Strip and Vinyl	9
Wood Parts	17
Balance Tube Replacement	20
Sash Replacement	26
Screens and Screen Parts	27
Discontinued – Limited Availability (LA) – Miscellaneous Parts	29
Discontinued – Limited Availability (LA) – Weather Strip and Vinyl	30
Discontinued – Limited Availability (LA) – Wood Parts	31
Discontinued – Limited Availability (LA) – Screen Parts	32
Discontinued – No Availability (NA) – Weather Strip and Vinyl	33

ATTENTION:

- Specification and technical data are subject to change without notice.
- Numbers listed in parentheses () are metric equivalents in millimeters rounded to the nearest whole number.

PRODUCED	UNIT TYPE	FEATURES OR CHANGES	STATUS
2006	Double Hung	<p>January 2006: Redesigned product introduction featuring DP40 on all sizes and DP50 w/HP kit on all sizes, more wood to the interior, new hardware and additional larger operating and picture units.</p> <p>July 2006: SDL offered on all Elevate Series windows and doors. 7/8" wide bars with Ultrex exterior and wood interior. See Product Bulletin 66 for more details.</p> <p>September 2006: Prairie SDL and GBG Lite cuts made available for the Elevate Series windows and doors. See Product Bulletin 70 for more details.</p>	Present Present Present
2007	Double Hung	<p>March 2007: Bronze exteriors introduced.</p> <p>November 2007: Evergreen exteriors introduced.</p>	Present
2008	Double Hung	<p>March 17, 2008: Cashmere exteriors introduced.</p> <p>June 2008: IZ3 products introduced.</p> <p>October 2008: CN68 equal sash introduced. Introduced Brass, Satin Nickel and Oil Rubbed Bronze hardware finishes for windows.</p>	Present
2009	Double Hung	<p>May 2009: LoE³ 366™ glass option introduced.</p>	Present
2010	Double Hung	<p>January 2010: Introduced the new grille tack and installation tool and added to accessory chapter.</p> <p>February 2010: Bottom Rail Weather-strip changed from V1561 and V1463 to V1930, Sill cover changed from W8793 to W10682.</p> <p>April 26, 2010: CN32 introduced. Tempered Obscure glass option introduced.</p>	Present
2011	Double Hung	<p>April 2011: Added 44" size to the ELDH product. LoE 180™ glass option introduced.</p> <p>September 2011: V2132, sash stop, replaces V1582.</p> <p>December 19, 2011: Introduced special sizes and through jamb installation option.</p>	Present
2012	Double Hung	<p>April 2012: Introduced STC ratings on select Elevate products.</p> <p>June 2012: Simulated Checkrail Bar option introduced.</p> <p>August 6, 2012 – Balance Tube and Sash Stop changes made to select IZ3 units.</p> <p>August 27, 2012: Introduced Ebony exterior and exterior casing options.</p> <p>October 29, 2012: Introduced Expanded Sizes and Mulls.</p>	Present
2013	Double Hung	<p>February 25, 2013 – Leaf spring replaced the stationary screen pin.</p> <p>December 16, 2013 – Introduced special sizes on IZ3 products.</p> <p>December 16, 2013 – Checkrail cover W8783 changed to W11916.</p>	Present
2014	Double Hung	<p>August 25, 2014 – Discontinued use of the jamb adjustment insert.</p>	Present
2015	Double Hung	<p>April 27, 2015 – Introduced expanded sizes, new bottom rail extension with weather strip. New Factory Applied HP kit for ELDH/ELDHP/ELDTR</p> <p>August 31, 2015 – Half Screens introduced for ELDH products.</p>	Present
2016	Double Hung	<p>August 29, 2016 – ELDH Improvements – Replaced bottom rail extension and weather strip.</p>	Present
2017	Double Hung	<p>December 18, 2017 – Added the availability of customer specified lite cut configurations for SDL with and with out spacer bar and GBG. To include simulated check rail and any color GBG to the exterior only of standard and special sizes.</p>	Present
October 2018	Double Hung	<p>October 29, 2018: Introduced Designer Black and Clear interior finishes and Matte Black (MBK) hardware option.</p> <p>All Balance tubes were changed to Mill Finish for Top and Bottom sash.</p> <p>Low E3 ERS glass type was added.</p>	Present
December 2018	Double Hung	<p>December 17, 2018: Introduced textured glass types: Reed, Narrow Reed, Rain, Glue Chip and Frost and also colored glass types: Clear, Bronze, Gray and Green.</p>	Present
December 2019	Double Hung	<p>December 16, 2019: Discontinued sale of Wood Removable Grilles.</p>	Present

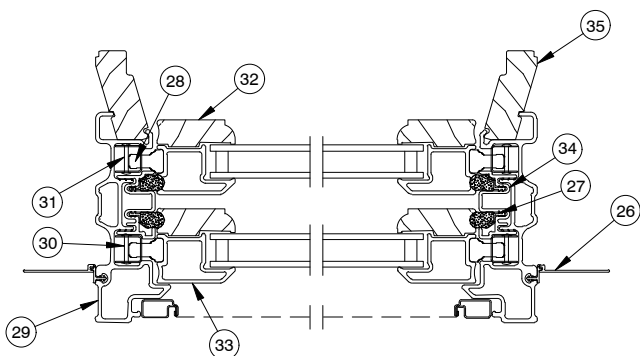
**DOUBLE HUNG
Operator**



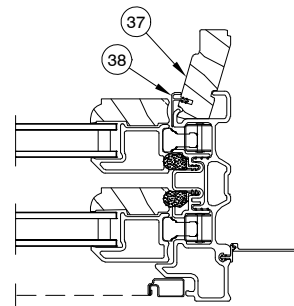
**Head Jamb
Painted units only**

1. Head Jamb Nailing Fin/Drip Cap
2. Head Jamb (Ultrax)
3. Head Jamb Liner
4. Head Jamb Part Stop
5. Top Rail (Ultrax)
6. Top Rail
7. Top Check Rail
8. Sash Keeper
9. Sash Lock
10. Bottom Check Rail Cover
11. Top Check Rail (Ultrax)
12. Top Check Rail Weather Strip
13. Bottom Check Rail (Ultrax)
14. Bottom Check Rail
15. Insulating Glass
16. Bottom Rail
17. Bottom Rail (Ultrax)
18. Sill Cover Foam Tape
19. Sill (Ultrax)
20. Sill Cover
21. Connecting Barb
22. Sill Liner
23. Screen Mesh
24. Screen Frame
25. Sill Nailing Fin
26. Jamb Nailing Fin
27. Frame Weather Strip, V2510
28. Sash Pivot Pin
29. Jamb (Ultrax)
30. Top Sash Balance Tube Assembly
31. Bottom Sash Balance Tube Assembly
32. Stile
33. Stile (Ultrax)
34. Jamb Carrier Assembly
35. Jamb Liner
36. Bottom Rail Extension w/Weather Strip
37. Head Jamb/Jamb Liner with Kerf
38. Interior Jamb Cap

Head Jamb and Sill



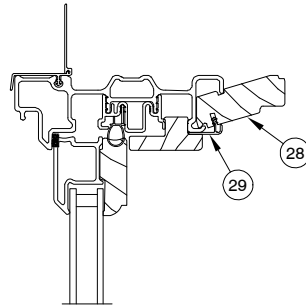
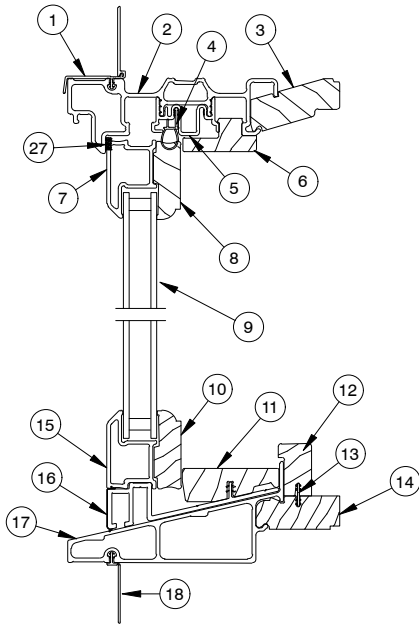
Jamb



**Jamb
Painted units only**

NOTE: Not to scale; specifications subject to change without notice.

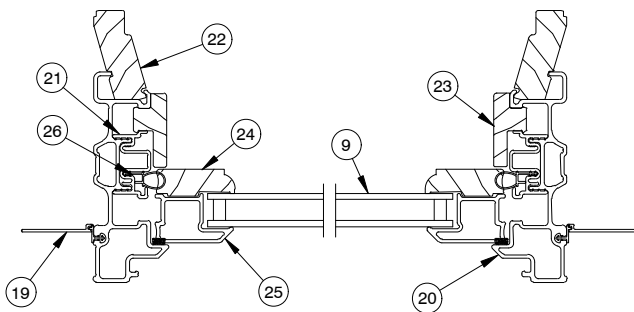
DOUBLE HUNG
Picture – Transom



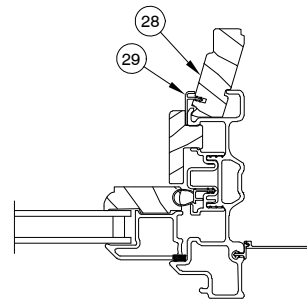
Head Jamb
Painted units only

1. Head Jamb Nailing Fin/Drip Cap
2. Head Jamb (Ultrax)
3. Head Jamb Liner
4. Head Frame Weather Strip
5. Head Jamb Carrier
6. Head Jamb Wood Stop
7. Top Rail (Ultrax)
8. Top Rail
9. Insulating Glass
10. Bottom Rail
11. Sill Wood Stop
12. Sill Cover
13. Connecting Barb
14. Sill Liner
15. Bottom Rail (Ultrax)
16. Vinyl Sill Filler
17. Sill (Ultrax)
18. Sill Nailing Fin
19. Jamb Nailing Fin
20. Jamb (Ultrax)
21. Vinyl Jamb Carrier
22. Jamb Liner
23. Jamb Wood Stop
24. Stile
25. Stile (Ultrax)
26. Frame Weather Strip, V1474
27. Stationary Frame Tape
28. Head Jamb/Jamb Liner with Kerf
29. Interior Jamb Cap

Head Jamb and Sill



Jamb



Jamb
Painted units only

NOTE: Not to scale; specifications subject to change without notice.

When ordering replacement hardware specify:

1. Type of unit;
2. Part number;
3. Description.

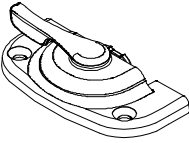

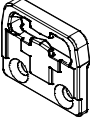
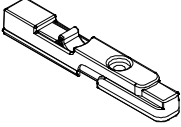
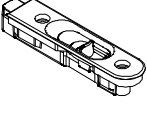
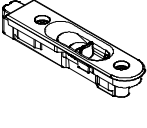
ILLUSTRATION <i>NOT TO SCALE</i>	DESCRIPTION	OPER./COLOR	PART NO.
	<p>Cam Lock <i>Uses 2 recommended fasteners: #6 x 1 1/2" Phillips flat head screws</i></p> <p><i>AF(11800341), WH (11800340), ORBZ (11800344), SN (11800343), BS (11800342), MBK(11800348)</i></p>	<p>Almond Frost (AF) White (WH) Oil Rubbed Bronze (ORBZ) Satin Nickel (SN) Brass (BS) Matte Black (MBK)</p>	<p>10150055 10150053 10150095 10150093 10150091 10150097</p>
	<p>Keeper <i>Uses 2 recommended fasteners: #6 x 1 1/2" Phillips flat head screws</i></p> <p><i>AF(11800341), WH (11800340), ORBZ (11800344), SN (11800343), BS (11800342), MBK (11800348)</i></p>	<p>Almond Frost (AF) White (WH) Oil Rubbed Bronze (ORBZ) Satin Nickel (SN) Brass (BS) Matte Black (MBK)</p>	<p>10840046 10840045 10840049 10840048 10840047 10840050</p>
	<p>Keeper, IZ3 <i>Uses 2 recommended fasteners: 2-#10 x 1 1/2" Phillips flat head screws</i></p> <p><i>AF(11806141), WH (11806142), ORBZ (11806145), SN (11806144), BS (11806143), MBK (11806138)</i></p>	<p>Almond Frost (AF) White (WH) Oil Rubbed Bronze (ORBZ) Satin Nickel (SN) Brass (BS) Matte Black (MBK)</p>	<p>11869782 11869781 11869785 11869784 11869783 11869780</p>
	<p>Tilt Latch, Top Sash includes: 1-#6 x 1 1/2" Phillips flat head screws</p>	<p>Beige</p>	<p>11869708</p>
	<p>Tilt Latch, Bottom Sash <i>Uses 2 recommended fasteners: #7 x 1 1/4 Phillips pan head screw</i></p> <p><i>AF(11807161), WH (11807160), ORBZ (11807165), SN (11807164) BS (11807163), BK (11807169)</i></p>	<p>Almond Frost (AF) White (WH) Oil Rubbed Bronze (ORBZ) Satin Nickel (SN) Brass (BS) Black (BK)</p>	<p>11869707 11869705 11869753 11869752 11869751 11869709</p>
	<p>Tilt Latch, Bottom Sash, IZ3 <i>Uses 2 recommended fasteners: #7 x 1 1/4 Phillips pan head screw</i></p> <p><i>AF(11807161), WH (11807160), ORBZ (11807165), SN (11807164) BS (11807163), BK (11807169)</i></p>	<p>Almond Frost (AF) White (WH) Oil Rubbed Bronze (ORBZ) Satin Nickel (SN) Brass (BS) Black (BK)</p>	<p>11869788 11869787 11869756 11869755 11869754 11869757</p>

ILLUSTRATION <i>NOT TO SCALE</i>	DESCRIPTION	OPER./COLOR	PART NO.
	<p>Pivot Pin, Top Sash <i>Includes:</i> 1-#7 x 3/4" Phillips pan head screw</p>		118625
	<p>Pivot Pin, Bottom Sash <i>Uses 1 recommended fastener:</i> #7 x 3/4" Phillips pan head screw (118036)</p>		10815279

When ordering replacement parts specify:

1. Type of unit;
2. Part number;
3. Description.


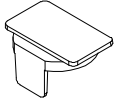
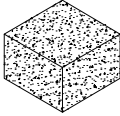

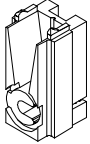
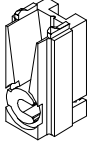
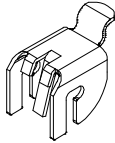

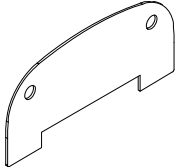
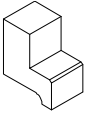
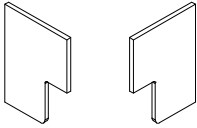
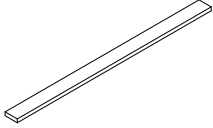
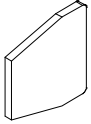
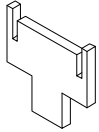
ILLUSTRATION <i>NOT TO SCALE</i>	DESCRIPTION	OPER./COLOR	PART NO.
	Check Rail Dust Block 1 1/4" x 1/2" <i>NOTE: Adhesive backed</i>	Gray	15608563
	WOCD Check Rail Landing	Clear White Black	10501055 10501056 10501057
	Balance Tube Foam Plug 3/4" x 3/4" x 1/2"	White	10500104
	Balance Tube Plug	Natural	10500174
	Balance Tube Clutch	Non-handed Gray	105530
	Balance Tube Clutch, IZ3	Non-handed Black	11867892
	Rotating Hanger Clip		106610
	Through Jamb Plug	Beige Black Stone White	11882969 11882971 11882970
	FOR SERVICE ONLY Lock Spacer		10506252

ILLUSTRATION NOT TO SCALE	DESCRIPTION	OPER./COLOR	PART NO.
	<p>Plug, Clutch Pocket Usage: 4/30/2013 to present</p>	<p>White Black</p>	<p>10501050 10601060</p>
	<p>End Seal, HP Sill Cover Kit Usage: 4/27/2015 to present <i>Includes:</i> 1pair – 1 LH and 1 RH <i>NOTE: This is for HP and IZ3 kits only.</i></p>	<p>Gray</p>	<p>10500405</p>
	<p>Stationary Sash Tape</p>	<p>50' (15 meters) Gray</p>	<p>11406228</p>
	<p>Jamb Liner Gasket</p>	<p>Beige</p>	<p>10500386</p>
	<p>Gasket End Cap Parting Stop Field Service only</p>	<p>Beige</p>	<p>10502060</p>

When ordering replacement weather strip and vinyl parts specify:

1. Description;
2. Profile number;
3. Part number;
4. Quantity.

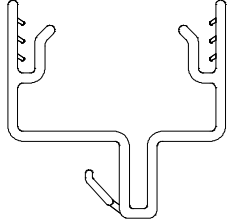

ILLUSTRATION <i>NOT TO SCALE</i>	DESCRIPTION	LENGTH	PART NO.		
			Beige	Black	White
	Head Jamb Parting Stop V1328				
	CN22	19 3/32" (485)	17003322	17005522	17005622
	CN26	23 3/32" (587)	17003326	17005526	17005626
	CN30	27 3/32" (688)	17003330	17005530	17005630
	CN32	29 3/32" (739)	17003332	17005532	17005632
	CN34	31 3/32" (790)	17003334	17005534	17005634
	CN36	33 3/32" (841)	17003336	17005536	17005636
	CN38	35 3/32" (891)	17003338	17005538	17005638
	CN42	39 3/32" (993)	17003342	17005542	17005642
	CN48	45 3/32" (1145)	17003348	17005548	17005648
	CN54	51 3/32" (1298)	17003354	17005554	17005654
		Frame Weather Strip – Operator V2510			
CN36		17 13/64" (437)	17013836	18013836	19013836
CN40		19 13/64" (488)	17013840	18013840	19013840
CN44		21 13/64" (538)	17013844	18013844	19013844
CN48		23 13/64" (589)	17013848	18013848	19013848
CN52		25 13/64" (640)	17013852	18013852	19013852
CN56/68TC		27 13/64" (691)	17013856	18013856	19013856
CN60		29 13/64" (742)	17013860	18013860	19013860
CN64		31 13/64" (792)	17013864	18013864	19013864
CN68		33 13/64" (843)	17013868	18013868	19013868
CN68BC		39 13/64" (996)	17013869	18013869	19013869
CN72		35 13/64" (894)	17013872	18013872	19013872
CN76		37 13/64" (945)	17013876	18013876	19013876
CN84		41 15/32" (1053)	17013884	18013884	19013884
Lineal		100" (2540)	17013800	18013800	19013800


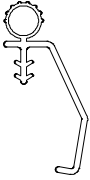
ILLUSTRATION <i>NOT TO SCALE</i>	DESCRIPTION	LENGTH	PART NO.																																																																												
	Jamb Frame Weather Strip – Picture and Transom V1474		Beige	Black	White																																																																										
	<table border="0"> <tr><td>CN16</td><td>13 7/8" (352)</td><td>17030016</td><td>17040016</td><td>17050016</td></tr> <tr><td>CN24</td><td>21 7/8" (556)</td><td>17030024</td><td>17040024</td><td>17050024</td></tr> <tr><td>CN36</td><td>33 7/8" (860)</td><td>17030036</td><td>17040036</td><td>17050036</td></tr> <tr><td>CN40</td><td>37 7/8" (962)</td><td>17030040</td><td>17040040</td><td>17050040</td></tr> <tr><td>CN44</td><td>41 7/8" (1064)</td><td>17030044</td><td>17040044</td><td>17050044</td></tr> <tr><td>CN48</td><td>45 7/8" (1165)</td><td>17030048</td><td>17040048</td><td>17050048</td></tr> <tr><td>CN52</td><td>49 7/8" (1267)</td><td>17030052</td><td>17041052</td><td>17050052</td></tr> <tr><td>CN56</td><td>53 7/8" (1368)</td><td>17030056</td><td>17041056</td><td>17050056</td></tr> <tr><td>CN60</td><td>57 7/8" (1470)</td><td>17030060</td><td>17041060</td><td>17050060</td></tr> <tr><td>CN64</td><td>61 7/8" (1571)</td><td>17030064</td><td>17041064</td><td>17050064</td></tr> <tr><td>CN68</td><td>65 7/8" (1673)</td><td>17030068</td><td>17042068</td><td>17050068</td></tr> <tr><td>CN72</td><td>69 7/8" (1775)</td><td>17030072</td><td>17041072</td><td>17050072</td></tr> <tr><td>CN76</td><td>73 7/8" (1876)</td><td>17030076</td><td>17041076</td><td>17050076</td></tr> <tr><td>CN84</td><td>82 3/8" (2092)</td><td>17030084</td><td>17041084</td><td>17050084</td></tr> <tr><td>Lineal</td><td>96" (2438)</td><td>17030099</td><td>17040099</td><td>17050099</td></tr> </table>	CN16	13 7/8" (352)	17030016	17040016	17050016	CN24	21 7/8" (556)	17030024	17040024	17050024	CN36	33 7/8" (860)	17030036	17040036	17050036	CN40	37 7/8" (962)	17030040	17040040	17050040	CN44	41 7/8" (1064)	17030044	17040044	17050044	CN48	45 7/8" (1165)	17030048	17040048	17050048	CN52	49 7/8" (1267)	17030052	17041052	17050052	CN56	53 7/8" (1368)	17030056	17041056	17050056	CN60	57 7/8" (1470)	17030060	17041060	17050060	CN64	61 7/8" (1571)	17030064	17041064	17050064	CN68	65 7/8" (1673)	17030068	17042068	17050068	CN72	69 7/8" (1775)	17030072	17041072	17050072	CN76	73 7/8" (1876)	17030076	17041076	17050076	CN84	82 3/8" (2092)	17030084	17041084	17050084	Lineal	96" (2438)	17030099	17040099	17050099			
CN16	13 7/8" (352)	17030016	17040016	17050016																																																																											
CN24	21 7/8" (556)	17030024	17040024	17050024																																																																											
CN36	33 7/8" (860)	17030036	17040036	17050036																																																																											
CN40	37 7/8" (962)	17030040	17040040	17050040																																																																											
CN44	41 7/8" (1064)	17030044	17040044	17050044																																																																											
CN48	45 7/8" (1165)	17030048	17040048	17050048																																																																											
CN52	49 7/8" (1267)	17030052	17041052	17050052																																																																											
CN56	53 7/8" (1368)	17030056	17041056	17050056																																																																											
CN60	57 7/8" (1470)	17030060	17041060	17050060																																																																											
CN64	61 7/8" (1571)	17030064	17041064	17050064																																																																											
CN68	65 7/8" (1673)	17030068	17042068	17050068																																																																											
CN72	69 7/8" (1775)	17030072	17041072	17050072																																																																											
CN76	73 7/8" (1876)	17030076	17041076	17050076																																																																											
CN84	82 3/8" (2092)	17030084	17041084	17050084																																																																											
Lineal	96" (2438)	17030099	17040099	17050099																																																																											
	Head Jamb Frame Weather Strip – Picture and Transom V1474		Beige	Black	White																																																																										
	<table border="0"> <tr><td>CN22</td><td>18 7/8" (479)</td><td>17030022</td><td>17040022</td><td>17050022</td></tr> <tr><td>CN26</td><td>22 7/8" (581)</td><td>17030026</td><td>17040026</td><td>17050026</td></tr> <tr><td>CN30</td><td>26 7/8" (683)</td><td>17030030</td><td>17040030</td><td>17050030</td></tr> <tr><td>CN32</td><td>28 7/8" (733)</td><td>17030032</td><td>17040032</td><td>17050032</td></tr> <tr><td>CN34</td><td>30 7/8" (784)</td><td>17030034</td><td>17040034</td><td>17050034</td></tr> <tr><td>CN36</td><td>33 7/8" (860)</td><td>17030036</td><td>17040036</td><td>17050036</td></tr> <tr><td>CN38</td><td>34 7/8" (886)</td><td>17030038</td><td>17040038</td><td>17050038</td></tr> <tr><td>CN42</td><td>38 7/8" (987)</td><td>17030042</td><td>17040042</td><td>17050042</td></tr> <tr><td>CN48</td><td>44 7/8" (1140)</td><td>17030049</td><td>17040049</td><td>17050049</td></tr> <tr><td>CN50</td><td>46 7/8" (1191)</td><td>17030050</td><td>17040050</td><td>17050050</td></tr> <tr><td>CN54</td><td>50 7/8" (1292)</td><td>17030054</td><td>17040054</td><td>17050054</td></tr> <tr><td>CN62</td><td>58 7/8" (1495)</td><td>17030062</td><td>17040062</td><td>17050062</td></tr> </table>	CN22	18 7/8" (479)	17030022	17040022	17050022	CN26	22 7/8" (581)	17030026	17040026	17050026	CN30	26 7/8" (683)	17030030	17040030	17050030	CN32	28 7/8" (733)	17030032	17040032	17050032	CN34	30 7/8" (784)	17030034	17040034	17050034	CN36	33 7/8" (860)	17030036	17040036	17050036	CN38	34 7/8" (886)	17030038	17040038	17050038	CN42	38 7/8" (987)	17030042	17040042	17050042	CN48	44 7/8" (1140)	17030049	17040049	17050049	CN50	46 7/8" (1191)	17030050	17040050	17050050	CN54	50 7/8" (1292)	17030054	17040054	17050054	CN62	58 7/8" (1495)	17030062	17040062	17050062																		
CN22	18 7/8" (479)	17030022	17040022	17050022																																																																											
CN26	22 7/8" (581)	17030026	17040026	17050026																																																																											
CN30	26 7/8" (683)	17030030	17040030	17050030																																																																											
CN32	28 7/8" (733)	17030032	17040032	17050032																																																																											
CN34	30 7/8" (784)	17030034	17040034	17050034																																																																											
CN36	33 7/8" (860)	17030036	17040036	17050036																																																																											
CN38	34 7/8" (886)	17030038	17040038	17050038																																																																											
CN42	38 7/8" (987)	17030042	17040042	17050042																																																																											
CN48	44 7/8" (1140)	17030049	17040049	17050049																																																																											
CN50	46 7/8" (1191)	17030050	17040050	17050050																																																																											
CN54	50 7/8" (1292)	17030054	17040054	17050054																																																																											
CN62	58 7/8" (1495)	17030062	17040062	17050062																																																																											
	Check Rail Weather Strip V1372		Beige	Black	White																																																																										
	<table border="0"> <tr><td>CN22</td><td>18 15/16" (481)</td><td>17007522</td><td>17008522</td><td>17009522</td></tr> <tr><td>CN26</td><td>22 15/16" (583)</td><td>17007526</td><td>17008526</td><td>17009526</td></tr> <tr><td>CN30</td><td>26 15/16" (684)</td><td>17007530</td><td>17008530</td><td>17009531</td></tr> <tr><td>CN32</td><td>28 15/16" (735)</td><td>17007532</td><td>17008532</td><td>17009533</td></tr> <tr><td>CN34</td><td>30 15/16" (786)</td><td>17007534</td><td>17008534</td><td>17009534</td></tr> <tr><td>CN36</td><td>32 15/16" (837)</td><td>17007536</td><td>17008537</td><td>17009537</td></tr> <tr><td>CN38</td><td>34 15/16" (888)</td><td>17007538</td><td>17008538</td><td>17009538</td></tr> <tr><td>CN42</td><td>38 15/16" (989)</td><td>17007542</td><td>17008542</td><td>17009543</td></tr> <tr><td>CN48</td><td>44 15/16" (1141)</td><td>17007548</td><td>17008549</td><td>17009549</td></tr> <tr><td>CN54</td><td>50 15/16" (1298)</td><td>17007554</td><td>17008554</td><td>17009555</td></tr> </table>	CN22	18 15/16" (481)	17007522	17008522	17009522	CN26	22 15/16" (583)	17007526	17008526	17009526	CN30	26 15/16" (684)	17007530	17008530	17009531	CN32	28 15/16" (735)	17007532	17008532	17009533	CN34	30 15/16" (786)	17007534	17008534	17009534	CN36	32 15/16" (837)	17007536	17008537	17009537	CN38	34 15/16" (888)	17007538	17008538	17009538	CN42	38 15/16" (989)	17007542	17008542	17009543	CN48	44 15/16" (1141)	17007548	17008549	17009549	CN54	50 15/16" (1298)	17007554	17008554	17009555																												
CN22	18 15/16" (481)	17007522	17008522	17009522																																																																											
CN26	22 15/16" (583)	17007526	17008526	17009526																																																																											
CN30	26 15/16" (684)	17007530	17008530	17009531																																																																											
CN32	28 15/16" (735)	17007532	17008532	17009533																																																																											
CN34	30 15/16" (786)	17007534	17008534	17009534																																																																											
CN36	32 15/16" (837)	17007536	17008537	17009537																																																																											
CN38	34 15/16" (888)	17007538	17008538	17009538																																																																											
CN42	38 15/16" (989)	17007542	17008542	17009543																																																																											
CN48	44 15/16" (1141)	17007548	17008549	17009549																																																																											
CN54	50 15/16" (1298)	17007554	17008554	17009555																																																																											

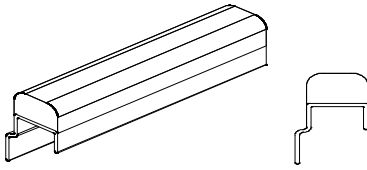
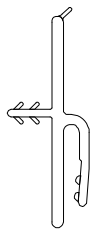
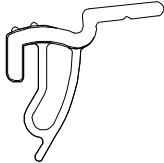
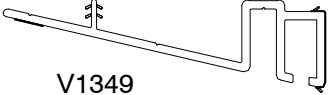
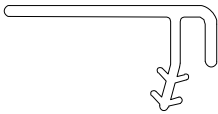
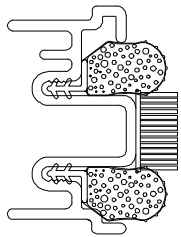
ILLUSTRATION NOT TO SCALE				
		<p>Sash Stop Used 9/6/2011 to Present</p>		
V2132				
DESCRIPTION	LENGTH	PART NO.		
		Beige	Black	White
Standard Units	2 3/16" (56)	11870224	11880224	11890224
Egress Units	1 13/32" (36)	11870144	11880144	11890144
ELDHIZ3 CN 3676 and CN 3876	6 11/16" (170)	11870674	11880674	11890674
ELDHIZ3 Cottage 3668 and 3868	6 11/16" (170)	11870674	11880674	11890674
ELDH Reverse Cottage	8" (203)	11870808	11880808	11890808
ELDH Reverse Cottage	12" (305)	11870812	11880812	11890812
ELDH Reverse Cottage	13 1/2" (343)	11870813	11880813	11890813
Lineal	96" (2438)	11870096	11880096	11890096

ILLUSTRATION NOT TO SCALE	DESCRIPTION	LENGTH	PART NO.
	HP Sill Cover Seal, ELDH V2531 - Gray		
	CN22	19 1/2" (496)	17005022
	CN26	23 1/2" (597)	17005026
	CN30	27 1/2" (699)	17005030
	CN32	29 1/2" (750)	17005032
	CN34	31 1/2" (800)	17005034
	CN36	33 1/2" (851)	17005036
	CN38	35 1/2" (902)	17005038
	CN42	39 1/2" (1004)	17005042
	CN48	45 1/2" (1156)	17005048
	CN50	47 1/2" (1207)	17005050
	CN54	51 1/2" (1308)	17005054
	CN62	59 1/2" (1512)	17005062

Description								
V2527				Sash Bottom Rail Extension with Weather Strip Usage: 8/29/2016 to present <i>NOTE: Screws #11806130 are not included need to be ordered separately (6-12 screws depending on size)</i>				
Size	CN	Color	Part Number		Size	CN	Color	Part Number
18 7/8" (479)	CN22	Cashmere	17019022		32 7/8" (835)	CN36	Cashmere	17019036
		Stone White	17019122				Stone White	17019136
		Pebble	17019222				Pebble	17019236
		Evergreen	17019322				Evergreen	17019336
		Bronze	17019422				Bronze	17019436
		Ebony	17019622				Ebony	17019636
22 7/8" (581)	CN26	Cashmere	17019026		34 7/8" (886)	CN38	Cashmere	17019038
		Stone White	17019126				Stone White	17019138
		Pebble	17019226				Pebble	17019238
		Evergreen	17019326				Evergreen	17019338
		Bronze	17019426				Bronze	17019438
		Ebony	17019626				Ebony	17019638
26 7/8" (683)	CN30	Cashmere	17019030	38 7/8" (987)	CN42	Cashmere	17019042	
		Stone White	17019130			Stone White	17019142	
		Pebble	17019230			Pebble	17019242	
		Evergreen	17019330			Evergreen	17019342	
		Bronze	17019430			Bronze	17019442	
		Ebony	17019630			Ebony	17019642	
28 7/8" (733)	CN32	Cashmere	17019032	44 7/8" (1140)	CN48	Cashmere	17019048	
		Stone White	17019132			Stone White	17019148	
		Pebble	17019232			Pebble	17019248	
		Evergreen	17019332			Evergreen	17019348	
		Bronze	17019432			Bronze	17019448	
		Ebony	17019632			Ebony	17019648	
30 7/8" (784)	CN34	Cashmere	17019034	50 7/8" (1292)	CN54	Cashmere	17019054	
		Stone White	17019134			Stone White	17019154	
		Pebble	17019234			Pebble	17019254	
		Evergreen	17019334			Evergreen	17019354	
		Bronze	17019434			Bronze	17019454	
		Ebony	17019634			Ebony	17019654	

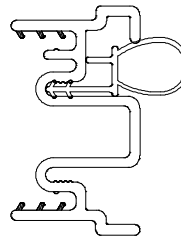
Description								
 <p>V1349</p>				<p>Sill Filler – Picture/Transom Usage: 5/2002 to present</p>				
Size	CN	Color	Part Number		Size	CN	Color	Part Number
19 1/8" (486)	CN22	Stone White	17000922		35 1/8" (892)	CN38	Stone White	17000938
		Pebble	17000822				Pebble	17000838
		Bronze	17000722				Bronze	17000738
		Evergreen	17000622				Evergreen	17000638
		Cashmere	17000522				Cashmere	17000538
		Ebony	17000222				Ebony	17000238
23 1/8" (587)	CN26	Stone White	17000926		39 1/8" (994)	CN42	Stone White	17000942
		Pebble	17000826				Pebble	17000842
		Bronze	17000726				Bronze	17000743
		Evergreen	17000626				Evergreen	17000643
		Cashmere	17000526				Cashmere	17000543
		Ebony	17000226				Ebony	17000243
27 1/8" (689)	CN30	Stone White	17000930	45 1/8" (1146)	CN48	Stone White	17000949	
		Pebble	17000830			Pebble	17000849	
		Bronze	17000731			Bronze	17000749	
		Evergreen	17000631			Evergreen	17000649	
		Cashmere	17000531			Cashmere	17000549	
		Ebony	17000231			Ebony	17000249	
29 1/8" (740)	CN32	Stone White	17000932	47 1/8" (1197)	CN50	Stone White	17000950	
		Pebble	17000832			Pebble	17000850	
		Bronze	17000732			Bronze	17000750	
		Evergreen	17000632			Evergreen	17000650	
		Cashmere	17000532			Cashmere	17000550	
		Ebony	17000232			Ebony	17000250	
31 1/8" (791)	CN34	Stone White	17000934	51 1/8" (1299)	CN54	Stone White	17000954	
		Pebble	17000834			Pebble	17000854	
		Bronze	17000734			Bronze	17000755	
		Evergreen	17000634			Evergreen	17000655	
		Cashmere	17000534			Cashmere	17000555	
		Ebony	17000234			Ebony	17000255	
33 1/8" (841)	CN36	Stone White	17000936	59 1/8" (1502)	CN62	Stone White	17000962	
		Pebble	17000836			Pebble	17000862	
		Bronze	17000737			Bronze	17000762	
		Evergreen	17000637			Evergreen	17000662	
		Cashmere	17000537			Cashmere	17000562	
		Ebony	17000237			Ebony	17000262	

V2955				A: Interior Jamb Cap B: Interior Head Jamb Cap		
Size		Designer Black - LH	Designer Black - RH	White - LH	White - RH	
A	12 1/2" (318)	CN16	15608515	15608516	15609515	15609516
	20 1/2" (521)	CN24	15608523	15608524	15609523	15609524
	32 1/2" (826)	CN36	15608535	15608536	15609535	15609536
	36 1/2" (927)	CN40	15608539	15608540	15609539	15609540
	38 1/2" (978)	CN42	15608541	15608642	15609541	15609642
	40 1/2" (1029)	CN44	15608543	15608544	15609543	15609544
	44 1/2" (1130)	CN48	15608547	15608548	15609547	15609548
	48 1/2" (1232)	CN52	15608551	15608552	15609551	15609552
	52 1/2" (1334)	CN56	15608555	15608556	15609555	15609556
	56 1/2" (1435)	CN60	15608559	15608560	15609559	15609560
	60 1/2" (1537)	CN64	15608562	15608564	15609563	15609564
	64 1/2" (1638)	CN68	15608567	15608568	15609567	15609568
	68 1/2" (1740)	CN72	15608571	15608572	15609571	15609572
	72 1/2" (1842)	CN76	15608575	15608576	15609575	15609576
	80 1/2" (2045)	CN84	15608585	15608586	15609585	15609586
Size		Black		White		
B	19 23/32" (501)	CN22	15608522	15609522		
	23 23/32" (602)	CN26	15608526	15609526		
	27 23/32" (704)	CN30	15608530	15609530		
	29 23/32" (755)	CN32	15608532	15609532		
	31 23/32" (806)	CN34	15608534	15609534		
	33 23/32" (856)	CN36	15608537	15609537		
	35 23/32" (907)	CN38	15608538	15609538		
	39 23/32" (1009)	CN42	15608542	15609542		
	45 23/32" (1161)	CN48	15608549	15609549		
	51 23/32" (1314)	CN54	15608554	15609554		
	57 23/32" (1466)	CN60	15608561	15609561		
	59 23/32" (1517)	CN62	15608662	15609562		
	69 23/32" (1771)	CN72	15608573	15609573		
	81 23/32" (2076)	CN84	15608584	15609584		
	93 23/32" (2380)	CN96	15608596	15609596		



A: Jamb Carrier Assembly Operator

includes:
V1327 Vinyl jamb carrier
V2510 Frame weather strip
Checkrail fuzzy



B: Jamb Carrier Assembly - Picture/Transom

C: Head Jamb Carrier Assembly - Picture/ Transom

includes:
V1327 Vinyl jamb carrier
V1474 Head jamb weather strip

Size			Beige LH	Beige RH	Black LH	Black RH	White LH	White RH
A	33 31/32" (863)	CN36	17370637	17370636	18370637	18370636	19370637	19370636
	37 31/32" (964)	CN40	17370641	17370640	18370641	18370640	19370641	19370640
	41 31/32" (1066)	CN44	17370645	17370644	18370645	18370644	19370645	19370644
	45 31/32" (1168)	CN48	17370649	17370648	18370649	18370648	19370649	19370648
	49 31/32" (1269)	CN52	17370653	17370652	18370653	18370652	19370653	19370652
	53 31/32" (1371)	CN56	17370657	17370656	18370657	18370656	19370657	19370656
	57 31/32" (1472)	CN60	17370661	17370660	18370661	18370660	19370661	19370660
	61 31/32" (1574)	CN64	17370665	17370664	18370665	18370664	19370665	19370664
	65 31/32" (1676)	CN68	17370569	17370568	18370569	18370568	19370569	19370568
	65 31/32" (1676)	CN68C	17370669	17370668	18370669	18370668	19370669	19370668
	69 31/32" (1777)	CN72	17370673	17370672	18370673	18370672	19370673	19370672
	73 31/32" (1879)	CN76	17370677	17370676	18370677	18370676	19370677	19370676
82 15/32" (2095)	CN84	17370685	17370684	18370685	18370684	19370685	19370684	
Size			Beige LH	Beige RH				
B	13 31/32" (355)	CN16	17370017	17370016				
	21 31/32" (558)	CN24	17370025	17370024				
	33 31/32" (863)	CN36	17370037	17370036				
	37 31/32" (964)	CN40	17370041	17370040				
	41 31/32" (1066)	CN44	17370045	17370044				
	45 31/32" (1168)	CN48	17370049	17370048				
	49 31/32" (1269)	CN52	17370053	17370052				
	53 31/32" (1371)	CN56	17370057	17370056				
	57 31/32" (1472)	CN60	17370061	17370060				
	61 31/32" (1574)	CN64	17370065	17370064				
	65 31/32" (1676)	CN68	17370069	17370068				
	69 31/32" (1777)	CN72	17370073	17370072				
73 31/32" (1879)	CN76	17370077	17370076					
82 15/32" (2095)	Lineal	17370085	17370084					
Size			Beige					
C	18 7/8" (479)	CN22	17370222					
	22 7/8" (581)	CN26	17370226					
	26 7/8" (683)	CN30	17370230					
	28 7/8" (733)	CN32	17370232					
	30 7/8" (784)	CN34	17370234					
	32 7/8" (835)	CN36	17370236					
	34 7/8" (886)	CN38	17370238					
	38 7/8" (987)	CN42	17370242					
	44 7/8" (1140)	CN48	17370248					
	46 7/8" (1191)	CN50	17370250					
50 7/8" (1292)	CN54	17370254						
58 7/8" (1495)	CN62	17370262						

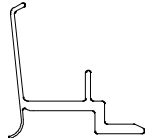
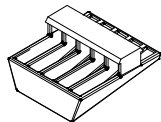

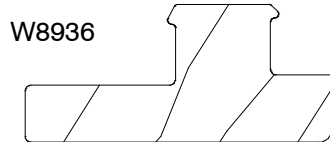
ILLUSTRATION <i>NOT TO SCALE</i>	DESCRIPTION	LENGTH	PART NO.					
	<p>Top Sash Interlock, ELDHIZ3 V1661</p> <p><i>Uses 6 recommended fasteners: #7 x 1 1/4 Phillips pan head screw</i></p> <p>BG(11807162) WH (11807160) MB (11807169)</p>		Beige	Black	White			
	CN22	18 31/32" (481)				17012922	17044922	17033922
	CN26	22 31/32" (583)				17012926	17044926	17033926
	CN30	26 31/32" (684)				17012930	17044931	17033931
	CN32	28 31/32" (735)				17012932	17044932	17033932
	CN34	30 31/32" (786)				17012934	17044934	17033934
	CN36	32 31/32" (837)				17012936	17044937	17033937
	CN38	34 31/32" (888)				17012938	17044938	17033938
	CN42	38 31/32" (989)				17012942	17044943	17033943
		<p>IZ3 Sill Block, ELDHIZ3</p>					Beige	Black
			11867891	11867993	11867992			

ILLUSTRATION <i>NOT TO SCALE</i>	DESCRIPTION	LENGTH	PART NO.	
	<p>Jamb Frame Stiffener – ELDHIZ3, ELDHPIZ3, ELDHTRIZ3 V1668 Beige</p>			
	CN16	11 1/2" (292)	11896764	
	CN40	35 1/2" (902)	11896765	
	CN44	39 1/2" (1003)	11896710	
	CN48	43 1/2" (1105)	11896766	
	CN52	47 1/2" (1207)	11896767	
	CN56	51 1/2" (1308)	11896768	
	CN60	55 1/2" (1410)	11896769	
	CN64	59 1/2" (1511)	11896770	
	CN68	63 1/2" (1613)	11896771	
	CN72	67 1/2" (1715)	11896772	
	CN76	71 1/2" (1816)	11896773	
	<p>Head Jamb Frame Stiffener – ELDHIZ3, ELDHPIZ3, ELDHTRIZ3 V1668 Beige</p>			
	CN22	17 1/2" (445)	11896774	
	CN26	21 1/2" (546)	11896775	
	CN30	25 1/2" (648)	11896776	
	CN32	27 1/2" (699)	11896815	
	CN34	29 1/2" (749)	11896777	
	CN36	31 1/2" (800)	11896778	
	CN38	33 1/2" (851)	11896779	
CN42	37 1/2" (953)	11896780		
CN50	45 1/2" (1156)	11896781		
CN54	49 1/2" (1257)	11896782		
CN62	57 1/2" (1461)	11896783		

TO ORDER REPLACEMENT WOOD PARTS

When ordering replacement wood parts specify:

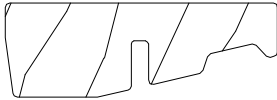
1. Profile number;
2. Part number;
3. Length;
4. Handing (if applicable);
5. Bare wood, White, Designer Black or Clear interior.

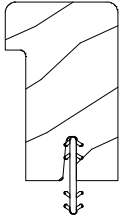


A: Interior Stop – Head Jamb Picture/Transom

B: Interior Stop – Jamb Picture/Transom

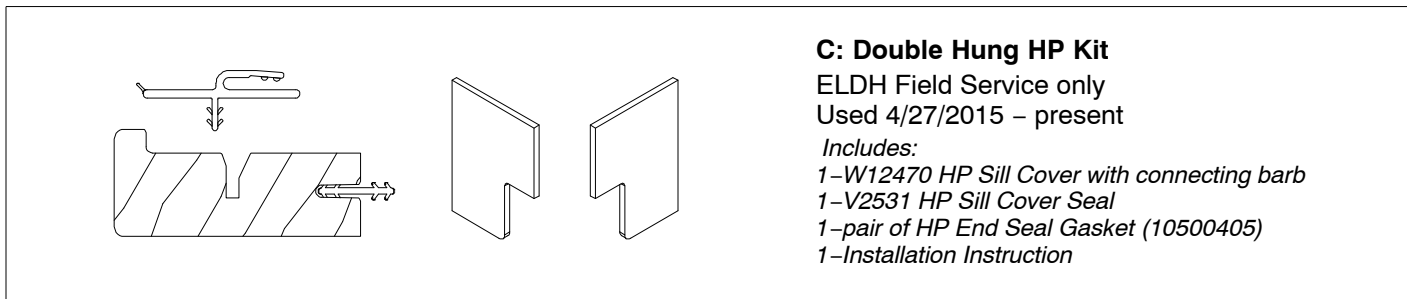
Size			Bare Wood	White	Designer Black	Clear
A	19 1/8" (486)	CN22	31510722	39212722	39930722	33830722
	23 1/8" (587)	CN26	31510726	39212726	39930726	33830726
	27 1/8" (689)	CN30	31510730	39212730	39930730	31610730
	29 1/8" (740)	CN32	31510732	39212732	39930732	33830732
	31 1/8" (791)	CN34	31510734	39212734	39930734	33830734
	33 1/8" (841)	CN36	31510736	39212735	39930736	33830736
	35 1/8" (892)	CN38	31510738	39212738	39930738	31610738
	39 1/8" (994)	CN42	31510742	39212742	39930742	33830742
	45 1/8" (1146)	CN48	31510748	39212747	39930748	33830748
	47 1/8" (1197)	CN50	31510750	39212750	39930750	33830750
	51 1/8" (1299)	CN54	31510754	39212754	39930754	33830754
59 1/8" (1502)	CN62	31510762	39212762	39930762	33830762	
B	12 17/64" (312)	CN16	31510816	39210816	39933816	31610816
	20 17/64" (515)	CN24	31510824	39210824	39933824	33833824
	32 17/64" (820)	CN36	31510837	39210837	39933836	33833836
	36 17/64" (922)	CN40	31510840	39210840	39933840	33833840
	40 17/64" (1023)	CN44	31510844	39210844	39933844	33833844
	44 17/64" (1124)	CN48	31510848	39210848	39933848	31610848
	48 17/64" (1226)	CN52	31510852	39210852	39933852	33833852
	52 17/64" (1328)	CN56	31510856	39210856	39933856	33833856
	56 17/64" (1429)	CN60	31510860	39210860	39933860	33833860
	60 17/64" (1531)	CN64	31510864	39210864	39933864	33833864
	64 17/64" (1632)	CN68	31510868	39210868	39933868	33833868
	68 17/64" (1734)	CN72	31510872	39210872	39933872	33833872
	72 17/64" (1836)	CN76	31510876	39210876	39933876	33833876
80 17/64" (2039)	CN84	31510884	39210884	39933884	33833884	

W8794				A: Interior Stop-Sill		
Size			Bare Wood	White	Designer Black	Clear
A	19 13/32" (493)	CN22	31510322	39210322	39219322	31610322
	23 13/32" (593)	CN26	31510326	39210326	39219326	31610326
	27 13/32" (696)	CN30	31510330	39210330	39219330	31610330
	29 13/32" (747)	CN32	31510332	39210332	39219332	31610332
	31 13/32" (798)	CN34	31510334	39210334	39219334	31610334
	33 13/32" (849)	CN36	31510336	39210336	39219336	31610336
	35 13/32" (899)	CN38	31510338	39210338	39219338	31610338
	39 13/32" (1001)	CN42	31510342	39210342	39219342	31610342
	45 13/32" (1153)	CN48	31510348	39210348	39219348	31610348
	47 13/32" (1204)	CN50	31510350	39210350	39219350	31610350
	51 13/32" (1306)	CN54	31510354	39210354	39219354	31610354
59 13/32" (1509)	CN62	31510362	39210362	39219362	31610362	

W10682				B: Sill Cover Kit Usage: 2/23/2010 – present W10682 Sill Cover with V803 connecting barb, foam tape, instructions		C: Sill Cover ELDHP Usage: 2/23/2010 – present W10682 Sill Cover with V803 connecting barb	
Size			Bare Wood	White	Designer Black	Clear	
B	19 29/32" (506)	CN22	11897198	11897204	11897501	11897601	
	23 29/32" (608)	CN26	11897199	11897205	11897502	11897602	
	27 29/32" (709)	CN30	11897200	11897206	11897503	11897603	
	29 29/32" (760)	CN32	11897230	11897231	11897504	11897604	
	31 29/32" (811)	CN34	11897213	11897207	11897505	11897605	
	33 29/32" (862)	CN36	11897201	11897208	11897506	11897606	
	35 29/32" (912)	CN38	11897202	11897209	11897507	11897607	
	39 29/32" (1014)	CN42	11897203	11897210	11897508	11897608	
C	47 29/32" (1217)	CN50	11897018	11897021	11897509	11897609	
	51 29/32" (1319)	CN54	11897019	11897022	11897510	11897610	
	59 29/32" (1522)	CN62	11897020	11897023	11897511	11897611	



Size			Bare Wood	White	Designer Black	Clear
A	97" (2464)		11896820	11896821	11896829	11896827
B	19 7/8" (505)	CN22	31516922	39216922	39219022	31616922
	23 7/8" (606)	CN26	31516926	39216926	39219026	31616926
	27 7/8" (708)	CN30	31516930	39216930	39219030	31616930
	29 7/8" (759)	CN32	31516932	39216932	39219032	31616932
	31 7/8" (810)	CN34	31516934	39216934	39219034	31616934
	33 7/8" (860)	CN36	31516936	39216936	39219036	31616936
	35 7/8" (911)	CN38	31516938	39216938	39219038	31616938
	39 7/8" (1013)	CN42	31516942	39216942	39219042	31616942
	45 7/8" (1165)	CN48	31516948	39216948	39219048	31616948
	47 7/8" (1216)	CN50	31516950	39216950	39219050	31616950
	51 7/8" (1317)	CN54	31516954	39216954	39219054	31616954
	59 7/8" (1521)	CN62	31516962	39216962	39219062	31616962



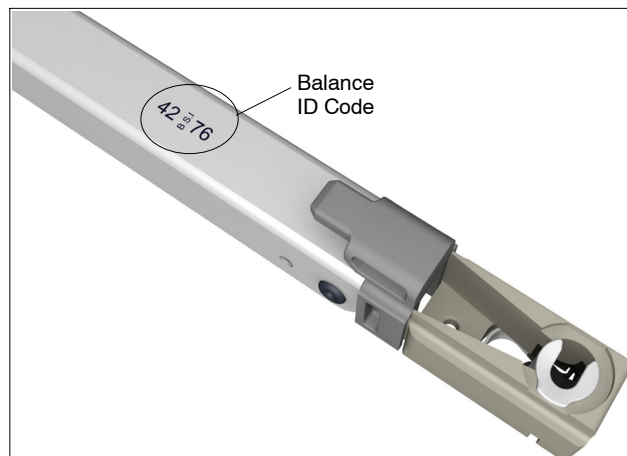
Size			Bare Wood	White	Designer Black	Clear
C		CN22	11886122	39256122	39936922	31616922
		CN26	11886126	39256126	39936926	33836926
		CN30	11886130	39256130	39936931	31606130
		CN32	11886132	39256132	39936932	33836932
		CN34	11886134	39256134	39936934	33836934
		CN36	11886136	39256136	39936936	33836936
		CN38	11886138	39256138	39936938	33836938
		CN42	11886142	39256142	39936942	33836942
		CN48	11886148	39256148	39936948	33836948
		CN50	11886150	39256150	39936952	33836950
		CN54	11886154	39256154	39936954	33836954
		CN62	11886162	39256162	39936962	33836962

BALANCE TUBES

Follow instructions below to order your balance tube.

1. Provide the original order number when possible (note if it's top or bottom sash).
2. Balance type and Balance ID code, they are imprinted on balance tube (see illustration below).
3. Weight of sash.
4. Specify top or bottom sash.
5. Specify quantity. Do **NOT** specify as pairs or sets. If one tube is needed, specify: quantity 1. If four tubes are needed, specify: quantity 4.

NOTE: As of October 29, 2018, all balance tubes will be mill finish. This change may result in mixed tube colors, if desired a second balance tube can be ordered to maintain a consistent appearance.



BALANCE TUBES – TOP

Part Number	Balance ID Code	Length (in)	Part Number	Balance ID Code	Length (in)	Part Number	Balance ID Code	Length (in)
Top Balance Tubes								
10665028	226-28	12	10665036	226-36	16	10665044	226-44	20
10665128	304-28	12	10665136	304-36	16	10665144	304-44	20
10665228	368-28	12	10665236	368-36	16	10665244	368-44	20
10665328	42-28	12	10665336	42-36	16	10665344	42-44	20
10778128	8128	12	10778136	8136	16	10778144	8144	20
10778228	8228	12	10778236	8236	16	10778244	8244	20
10778328	8328	12	10778436	8436	16	10778344	8344	20
10778428	8428	12	10778536	8536	16	10778444	8444	20
10778528	8528	12	10665038	226-38	17	10778544	8544	20
10665030	226-30	13	10665138	304-38	17	10665046	226-46	21
10665130	304-30	13	10665238	368-38	17	10665146	304-46	21
10665230	368-30	13	10665338	42-38	17	10665246	368-46	21
10665330	42-30	13	10778138	8138	17	10665346	42-46	21
10778130	8130	13	10778238	8238	17	10778146	8146	21
10778230	8230	13	10778338	8338	17	10778246	8246	21
10778330	8330	13	10778438	8438	17	10778346	8346	21
10778430	8430	13	10778538	8538	17	10778446	8446	21
10778530	8530	13	10665040	226-40	18	10778546	8546	21
10665032	226-32	14	10665140	304-40	18	10665048	226-48	22
10665132	304-32	14	10665240	368-40	18	10665148	304-48	22
10665232	368-32	14	10665340	42-40	18	10665248	368-48	22
10665332	42-32	14	10778140	8140	18	10665348	42-48	22
10778132	8132	14	10778240	8240	18	10778148	8148	22
10778232	8232	14	10778340	8340	18	10778248	8248	22
10778332	8332	14	10778440	8440	18	10778348	8348	22
10778432	8432	14	10778540	8540	18	10778448	8448	22
10778532	8532	14	10665042	226-42	19	10778548	8548	22
10665034	226-34	15	10665142	304-42	19	10665050	226-50	23
10665134	304-34	15	10665242	368-42	19	10665150	304-50	23
10665234	368-34	15	10665342	42-42	19	10665250	368-50	23
10665334	42-34	15	10778142	8142	19	10665350	42-50	23
10778134	8134	15	10778242	8242	19	10778150	8150	23
10778234	8234	15	10778342	8342	19	10778250	8250	23
10778334	8334	15	10778442	8442	19	10778350	8350	23
10778434	8434	15	10778542	8542	19	10778450	8450	23
10778534	8534	15						

BALANCE TUBES – TOP

Part Number	Balance ID Code	Length (in)	Part Number	Balance ID Code	Length (in)	Part Number	Balance ID Code	Length (in)
Top Balance Tubes								
10665052	226-52	24	10665060	226-60	28	10665068	226-68	32
10665152	304-52	24	10665160	304-60	28	10665168	304-68	32
10665252	368-52	24	10665260	368-60	28	10665268	368-68	32
10665352	42-52	24	10665360	42-60	28	10665368	42-68	32
10778152	8152	24	10778160	8160	28	10778169	8169	32
10778252	8252	24	10778260	8260	28	10778269	8269	32
10778352	8352	24	10778360	8360	28	10778369	8369	32
10778452	8452	24	10778460	8460	28	10778469	8469	32
10778552	8552	24	10778560	8560	28	10778569	8569	32
10665054	226-54	25	10665062	226-62	29	10665070	226-70	33
10665154	304-54	25	10665162	304-62	29	10665170	304-70	33
10665254	368-54	25	10665262	368-62	29	10665270	368-70	33
10665354	42-54	25	10665362	42-62	29	10665370	42-70	33
10778154	8154	25	10778162	8162	29	10778170	8170	33
10778254	8254	25	10778262	8262	29	10778270	8270	33
10778354	8354	25	10778362	8362	29	10778370	8370	33
10778454	8454	25	10778562	8562	29	10778470	8470	33
10778554	8554	25	10665064	226-64	30	10778570	8570	33
10665056	226-56C68	26	10665164	304-64	30	10665072	226-72	34
10665156	304-56C68	26	10665264	368-64	30	10665172	304-72	34
10665256	368-56C68	26	10665364	42-64	30	10665272	368-72	34
10665356	42-56C68	26	10778164	8164	30	10665372	42-72	34
10778156	8156	26	10778264	8264	30	10778172	8172	34
10778256	8256	26	10778364	8364	30	10778272	8272	34
10778356	8356	26	10778464	8464	30	10778372	8372	34
10778456	8456	26	10778564	8564	30	10778472	8472	34
10778556	8556	26	10665066	226-66	31	10778572	8572	34
10665058	226-58	27	10665166	304-66	31	10665074	226-74	35
10665158	304-58	27	10665266	368-66	31	10665174	304-74	35
10665258	368-58	27	10665366	42-66	31	10665274	368-74	35
10665358	42-58	27	10778166	8166	31	10665374	42-74	35
10778158	8158	27	10778266	8266	31	10778174	8174	35
10778258	8258	27	10778366	8366	31	10778274	8274	35
10778358	8358	27	10778466	8466	31	10778374	8374	35
10778458	8458	27	10778566	8566	31	10778474	8474	35
10778558	8558	27				10778574	8574	35

BALANCE TUBES – TOP

Part Number	Balance ID Code	Length (in)	Part Number	Balance ID Code	Length (in)
Top Balance Tubes					
10665076	226-76	36	10665082	226-82	39
10665176	304-76	36	10665182	304-82	39
10665276	368-76	36	10665282	368-82	39
10665376	42-76	36	10665382	42-82	39
10778176	8176	36	10778182	8182	39
10778276	8276	36	10778282	8282	39
10778376	8376	36	10778382	8382	39
10778476	8476	36	10778482	8482	39
10778576	8576	36	10778582	8582	39
10665078	226-78	37	10665084	226-84	40
10665178	304-78	37	10665184	304-84	40
10665278	368-78	37	10665284	368-84	40
10665378	42-78	37	10665384	42-84	40
10778178	8178	37	10778184	8184	40
10778278	8278	37	10778284	8284	40
10778378	8378	37	10778384	8384	40
10778478	8478	37	10778484	8484	40
10778578	8578	37			
10665080	226-80	38			
10665180	304-80	38			
10665280	368-80	38			
10665380	42-80	38			
10778180	8180	38			
10778280	8280	38			
10778380	8380	38			
10778480	8480	38			

BALANCE TUBES – BOTTOM

Part Number	Balance ID Code	Length (in)	Part Number	Balance ID Code	Length (in)	Part Number	Balance ID Code	Length (in)
Bottom Balance Tubes								
10777028	226-28	12.875	10777040	226-40	18.875	10779348	9348	22.875
10777128	304-28	12.875	10777140	304-40	18.875	10779448	9448	22.875
10777228	368-28	12.875	10777240	368-40	18.875	10777050	226-50	23.875
10779328	9328	12.875	10777340	42-40	18.875	10777150	304-50	23.875
10777328	42-28	12.875	10779240	9240	18.875	10777250	368-50	23.875
10779128	9128	12.875	10779340	9340	18.875	10777350	42-50	23.875
10779428	9428	12.875	10779440	9440	18.875	10779350	9350	23.875
10777030	226-30	13.875	10777042	226-42	19.875	10779150	9150	23.875
10777130	304-30	13.875	10777142	304-42	19.875	10779250	9250	23.875
10777230	368-30	13.875	10777242	368-42	19.875	10777052	226-52	24.875
10777330	42-30	13.875	10777342	42-42	19.875	10777152	304-52	24.875
10779130	9130	13.875	10779142	9142	19.875	10777252	368-52	24.875
10779230	9230	13.875	10779342	9342	19.875	10779152	9152	24.875
10777032	226-32	14.875	10779442	9442	19.875	10777352	42-52	24.875
10777132	304-32	14.875	10779242	9242	19.875	10779252	9252	24.875
10777232	368-32	14.875	10777044	226-44	20.875	10779352	9352	24.875
10777332	42-32	14.875	10777144	304-44	20.875	10777054	226-54	25.875
10777034	226-34	15.875	10777244	368-44	20.875	10777154	304-54	25.875
10777134	304-34	15.875	10777344	42-44	20.875	10777254	368-54	25.875
10777234	368-34	15.875	10779144	9144	20.875	10777354	42-54	25.875
10777334	42-34	15.875	10779244	9244	20.875	10779154	9154	25.875
10779234	9234	15.875	10779444	9444	20.875	10779254	9254	25.875
10777036	226-36	16.875	10779344	9344	20.875	10777056	226-56	26.875
10777136	304-36	16.875	10777046	226-46	21.875	10777156	304-56	26.875
10777236	368-36	16.875	10777146	304-46	21.875	10777256	368-56	26.545
10777336	42-36	16.875	10777246	368-46	21.875	10779155	9155	26.545
10779236	9236	16.875	10779146	9146	21.875	10777356	42-56	26.545
10779136	9136	16.875	10777346	42-46	21.875	10779255	9255	26.545
10779336	9336	16.875	10779346	9346	21.875	10777255	368-55	26.875
10779436	9436	16.875	10779446	9446	21.875	10779156	9156	26.875
10777038	226-38	17.875	10779246	9246	21.875	10777355	42-55	26.875
10777138	304-38	17.875	10777048	226-48	22.875	10779256	9256	26.875
10777238	368-38	17.875	10777148	304-48	22.875	10779456	9456	26.875
10777338	42-38	17.875	10777248	368-48	22.875	10779356	9356	26.875
10779338	9338	17.875	10779248	9248	22.875	10779556	9556	26.875
10779238	9238	17.875	10779148	9148	22.875			

BALANCE TUBES – BOTTOM

Part Number	Balance ID Code	Length (in)	Part Number	Balance ID Code	Length (in)	Part Number	Balance ID Code	Length (in)
Bottom Balance Tubes								
10777058	226-58	27.875	10777366	42-66	31.875	10777076	226-76C68	36.875
10777158	304-58	27.875	10779166	9166	31.875	10777176	304-76C68	36.875
10777258	368-58	27.875	10779366	9366	31.875	10777276	368-76C68	36.875
10777358	42-58	27.875	10779266	9266	31.875	10777376	42-76C68	36.875
10779358	9358	27.875	10779566	9566	31.875	10779176	9176	36.875
10779158	9158	27.875	10777068	226-68	32.875	10779276	9276	36.875
10779458	9458	27.875	10777168	304-68	32.875	10779376	9376	36.875
10779258	9258	27.875	10779169	9169	32.875	10779476	9476	36.875
10779558	9558	27.875	10777268	368-68	32.875	10777078	226-78	37.875
10777060	226-60	28.875	10777368	42-68	32.875	10777178	304-78	37.875
10777160	304-60	28.875	10779269	9269	32.875	10777278	368-78	37.875
10777260	368-60	28.875	10779469	9469	32.875	10777378	42-78	37.875
10777261	368-61	28.545	10779569	9569	32.875	10779178	9178	37.875
10777360	42-60	28.875	10777070	226-70	33.875	10779278	9278	37.875
10777359	42-59	28.545	10777170	304-70	33.875	10779378	9378	37.875
10779160	9160	28.875	10777270	368-70	33.875	10779478	9478	37.875
10779159	9159	28.545	10777370	42-70	33.875	10777080	226-80	38.875
10779260	9260	28.875	10779170	9170	33.875	10777180	304-80	38.875
10779460	9460	28.875	10779370	9370	33.875	10777280	368-80	38.875
10777062	226-62	29.875	10779270	9270	33.875	10777380	42-80	38.875
10777162	304-62	29.875	10779470	9470	33.875	10779180	9180	38.875
10777262	368-62	29.875	10777072	226-72	34.875	10779280	9280	38.875
10777362	42-62	29.875	10777172	304-72	34.875	10779480	9480	38.875
10779162	9162	29.875	10777272	368-72	34.875	10777082	226-82	39.875
10779562	9562	29.875	10779172	9172	34.875	10777182	304-82	39.875
10779262	9262	29.875	10779272	9272	34.875	10777282	368-82	39.875
10777064	226-64	30.875	10777372	42-72	34.875	10777382	42-82	39.875
10777164	304-64	30.875	10779372	9372	34.875	10779182	9182	39.875
10779164	9164	30.875	10779472	9472	34.875	10779282	9282	39.875
10777264	368-64	30.875	10777074	226-74	35.875	10779482	9482	39.875
10779264	9264	30.875	10777174	304-74	35.875	10777084	226-84	40.875
10777364	42-64	30.875	10777274	368-74	35.875	10777184	304-84	40.875
10779364	9364	30.875	10777374	42-74	35.875	10777284	368-84	40.875
10777066	226-66	31.875	10779174	9174	35.875	10777384	42-84	40.875
10777166	304-66	31.875	10779374	9374	35.875	10779184	9184	40.875
10777266	368-66	31.875	10779474	9474	35.875	10779284	9284	40.875
			10779274	9274	35.875	10779384	9384	40.875

ORDERING REPLACEMENT SASH

When ordering replacement sash specify:

1. Top, bottom or pair of sash;
2. Size (using chart below);
3. Sash exterior color;
4. Hardware color;
5. Glazing;
6. Bare wood, White, Designer Black, or Clear interior.

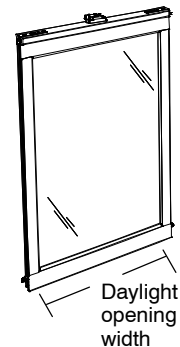
Sash Sizes			
Daylight Opening to OM of Sash			
Daylight Width + 3 1/4" = OM Width of Sash			
Daylight Height + 3 1/4" = OM Height of Sash			
NOTE: Sash is not reglazable			
Operator Sash			
Width		Height	
Size	OM Width	Size	OM Height
CN22	18 15/16" (481)	CN36	16 15/16" (430)
CN26	22 15/16" (583)	CN40	18 15/16" (481)
CN30	26 15/16" (684)	CN44	20 15/16" (532)
CN32	28 15/16" (735)	CN48	22 15/16" (583)
CN34	30 15/16" (786)	CN52	24 15/16" (633)
CN36	32 15/16" (837)	CN56	26 15/16" (684)
CN38	34 15/16" (888)	CN60	28 15/16" (735)
CN42	38 15/16" (988)	CN64	30 15/16" (786)
CN48	44 15/16" (1141)	CN68	32 15/16" (837)
CN54	54 15/16" (1294)	CN72	34 15/16" (887)
		CN76	36 15/16" (938)
Picture/Transom Sash			
CN22	18 15/16" (481)	CN16	12 15/16" (329)
CN26	22 15/16" (583)	CN24	20 15/16" (532)
CN30	26 15/16" (684)	CN36	32 15/16" (837)
CN32	28 15/16" (735)	CN40	36 15/16" (938)
CN34	30 15/16" (786)	CN44	40 15/16" (1040)
CN36	32 15/16" (837)	CN48	44 15/16" (1141)
CN38	34 15/16" (888)	CN52	48 15/16" (1243)
CN42	38 15/16" (988)	CN56	52 15/16" (1345)
CN48	44 15/16" (1141)	CN60	56 15/16" (1446)
CN50	46 15/16" (1192)	CN64	60 15/16" (1548)
CN54	50 15/16" (1294)	CN68	64 15/16" (1649)
CN62	58 15/16" (1497)	CN72	68 15/16" (1751)
		CN76	72 15/16" (1853)

NOTE: Replacement sash is supplied with weather strip and hardware. Daylight opening is the measurement of visible glass. Double Hung picture replacement sash includes attached sill filler.

Top Sash Interior View



Bottom Sash Interior View



ORDERING REPLACEMENT SCREENS

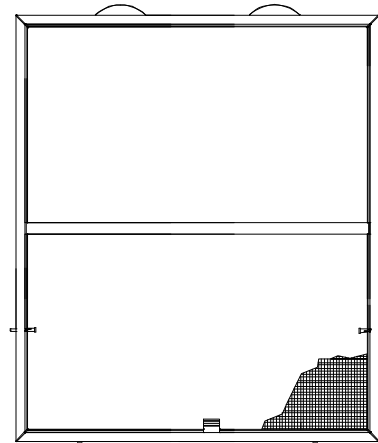
Screens are standard with a white or pebble gray aluminum surround and charcoal colored fiberglass 18x16 screen mesh. Determine the outside measurement of the existing screen. Find the sizes that correspond to the width and height indicated on the following chart.

When ordering replacement screen specify:

1. Specify full or half screen.
2. Size; – if there is no existing screen from which to obtain the OM of the screen, determine the size of the screen by using the conversion chart below. The daylight opening is the measurement of the visible glass.
3. Color
4. Specify cottage or equal sash when ordering CN68 height.

Screen Sizes for Elevate Double Hung manufactured January 2006 to present			
Daylight Opening to OM of Screen			
Daylight Width + 3 13/16" (97)= OM Width of Screen			
Daylight Height x 2 + 6 3/4" (171)= OM Height of Full Screen			
Daylight Height + 4 1/32" (102)= OM Height of Half Screen			
<i>NOTE: Screen feature plunger type mounting system.</i>			
Width		Height of Full Screen	
Size	OM Width	Size	OM Height
CN 22	19 1/2" (495)	CN 36	34 1/8" (867)
CN 26	23 1/2" (597)	CN 40	38 1/8" (968)
CN 30	27 1/2" (699)	CN 44	42 1/8" (1070)
CN 32	29 1/2" (749)	CN 48	46 1/8" (1172)
CN 34	31 1/2" (800)	CN 52	50 1/8" (1273)
CN 36	33 1/2" (851)	CN 56	54 1/8" (1375)
CN 38	35 1/2" (902)	CN 60	58 1/8" (1476)
CN 42	39 1/2" (1003)	CN 64	62 1/8" (1578)
CN 48	45 1/2" (1156)	CN 68	66 1/8" (1680)
CN 54	51 1/2" (1308)	CN 72	70 1/8" (1781)
		CN 76	74 1/8" (1863)
Width		Height of Half Screen	
Size	OM Width	Size	OM Height
CN 22	19 1/2" (495)	CN 36	17 23/32" (450)
CN 26	23 1/2" (597)	CN 40	19 23/32" (501)
CN 30	27 1/2" (699)	CN 44	21 23/32" (552)
CN 32	29 1/2" (749)	CN 48	23 23/32" (602)
CN 34	31 1/2" (800)	CN 52	25 23/32" (653)
CN 36	33 1/2" (851)	CN 56	27 23/32" (704)
CN 38	35 1/2" (902)	CN 60	29 23/32" (755)
CN 42	39 1/2" (1003)	CN 64	31 23/32" (806)
CN 48	45 1/2" (1156)	CN 68	33 23/32" (856)
CN 54	51 1/2" (1308)	CN 72	35 23/32" (907)
		CN 76	37 23/32" (958)

NOTE: Measure top and bottom sash separately when calculating screen OM height. CN36 and CN40 screens do not feature cross bars.



NOTE: OM of screen includes corner keys.

NOTE: Half screens do not feature cross bars.

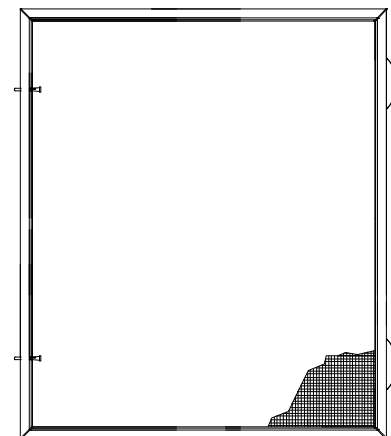


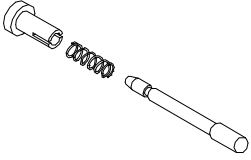
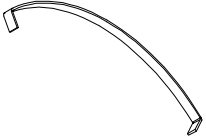


ILLUSTRATION NOT TO SCALE	DESCRIPTION	OPER./COLOR	PART NO.
	<p>Plunger and Spring Assembly-M060 Includes: 1 - Plunger bolt 1 - Plunger bolt cap 1 - Plunger bolt spring</p>	<p>Clear Cap Off White Bolt</p>	<p>11900896</p>
	<p>Leaf Spring Usage: 2/26/2013 - Present</p>		<p>11900897</p>
	<p>Flat Grille Bumper</p>	<p>Clear</p>	<p>11860561</p>
	<p>Half Screen, Pile Weather Strip, 12" Note: Part number is available in 12" increments.</p>	<p>Black</p>	<p>15619612</p>

ILLUSTRATION NOT TO SCALE	DESCRIPTION	OPER./COLOR	PART NO.
	Plug, Bottom Sash Stop ELDH Field Service only Usage: 4/22/2010–4/29/2013 <i>NOTE: Adhesive transfer tape applied.</i>		10506254

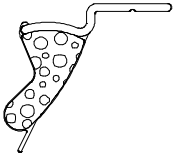
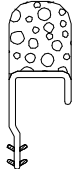
ILLUSTRATION NOT TO SCALE	DESCRIPTION	LENGTH	PART NO.
	<p>Bottom Sash Weather Strip Kit V1930 BG Used 2/23/2012 to 4/27/2015 ELDH Field Service only</p> <p><i>Includes:</i> Weather Strip 6 – #8 x 3/4" screws 1 – instruction</p>		
	CN22	18 11/16" (475)	11897191
	CN26	22 11/16" (576)	11897192
	CN30	26 11/16" (678)	11897193
	CN32	28 11/16" (729)	11897040
	CN34	30 11/16" (779)	11897194
	CN36	32 11/16" (830)	11897195
	CN38	34 11/16" (881)	11897196
	CN42	38 11/16" (983)	11897197
	<p>Bottom Sash Stop V1530 – Beige ELDH Field Service only Used 1/1/2006–4/18/2007</p>		
	ELDH	1 7/16" (37)	11870200
	ELDH Egress	3/4" (19)	11870201
	Lineal	96" (2438)	11870299

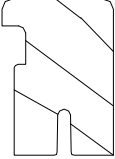
ILLUSTRATION <i>NOT TO SCALE</i>	DESCRIPTION	LENGTH	BARE WOOD PART NO.	WHITE INTERIOR PART NO.
 <p>W8793 – Sill Cover – uses V803 connecting barb, not included</p>	<p>Sill Cover W8793 Usage: 1/1/2006–2/22/2010</p>			
	CN22	19 29/32" (506)	31509222	39209222
	CN26	23 29/32" (608)	31509226	39209226
	CN30	27 29/32" (709)	31509230	39209230
	CN34	31 29/32" (811)	31509234	39209234
	CN36	33 29/32" (862)	31509236	39209236
	CN38	35 29/32" (912)	31509238	39209238
	CN42	39 29/32" (1014)	31509242	39209242
	CN50	47 29/32" (1217)	31509250	39209250
	CN54	51 29/32" (1319)	31509254	39209254
	CN62	59 29/32" (1522)	31509262	39209262

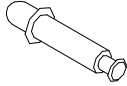

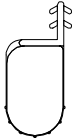
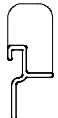

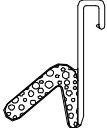
ILLUSTRATION <i>NOT TO SCALE</i>	DESCRIPTION	COLOR	PART NO.
	Stationary Screen Pin Usage: 1/2006–2/25/2013	Clear	11867852

ILLUSTRATION <i>NOT TO SCALE</i>	DESCRIPTION	LENGTH	PART NO.
	<p>Bottom Rail Weather Strip V2550 Usage: 4/27/2015–8/29/2016</p>		<p>Discontinued Replace with V2527 (Instructions are available PN 19972212).</p>
	<p>Frame Weather Strip V2505 Used: 8/2014–7/2015</p>		<p>Discontinued replace with V2510</p>
	<p>Sash Stop V1582 – Beige Used 1/2006 to 9/2011</p>		<p>Discontinued replace with V2132</p>
 <p data-bbox="172 898 451 947"><i>NOTE: Shown with adhesive tape applied.</i></p>	<p>Bottom Rail Weather Strip V1561 – Beige Field Service only Used 1/1/2006–2/22/2010</p>		<p>Replace with V2527 (Instructions are available PN 19972212.)</p>
	<p>Sill Weather Strip V1463 Field Service only Used 1/1/2006–2/22/2010</p>		