

Coastline Multi-Slide Door

Unit Features.....	1
Minimum and Maximum Guidelines	3
Configurations	4
COMSD 4.562 IZ4, COMSD 3.187 IZ4, COMSD 3.187 CNR IZ4 Vertical Section Details.....	5
COMSD 4.562 IZ4 Horizontal Section Details.....	6
COMSD 3.187 IZ4 Horizontal Section Details.....	7
COMSD 3.187 CNR IZ4 Horizontal Section Details.....	8

Unit Features

Product Name: Coastline Multi-Slide Door IZ4

Product Series:

- COMSD 4.562 IZ4 (Residential and Hi-Rise formerly known as 600KM)
- COMSD 3.187 IZ4 (Formerly known as 600KM-12)
- COMSD 3.187 CNR IZ4

Abbreviation: COMSD 4.562 IZ4, COMSD 3.187 IZ4, COMSD 3.187 CNR IZ4

Frame and Panels:

- Frame and panels constructed with heavy-duty aluminum
- COMSD 4.562 IZ4 available in Residential or Hi-Rise series
- COMSD 3.187 IZ4 and COMSD 3.187 CNR IZ4 available in STD or HD series
- Frame depth is based on number of tracks (2 to 5 tracks available)
- Optional Color Finishes:
 - White
 - Bronze
 - Anodized
 - Walnut
 - Hazelnut
 - Red Cinnamon
 - English Oak
 - White Kynar
 - Bronze Kynar
 - Black Kynar
 - Custom Colors available

Style Options:

- Pocket Door (1 to 10 panel options, interior or exterior pocket panel options)
- Bypass Door (2 to 10 panel options)
- Right and Left
- Center meeting
- 90° Corner Door
- Pass Thru

Hardware:

- 2 Point or 4 Point (90° Corner Door Lock)
- Keyed Lock Available
- Standard Handle:
 - White
 - Black
 - Satin Nickel
- Euro Crest Handle:
 - White
 - Black
 - Bronze
 - Brushed Nickel
- Standard and Euro Crest Handles have optional dummy
- Exterior Recess Pull with Screens

Sill:

- COMSD 4.562 IZ4 - Residential/Hi-Rise: Low (2.250"), Medium (2.750"), and High (4.000")
- COMSD 3.187 IZ4: Medium (2.750") and High (4.000")
- COMSD 3.187 CNR IZ4: Medium (2.750") and High (4.000")

Divided Lite Options:

- 1 Lite
- Equal Rectangular (1" and 2" Flat available)

Weather Strip:

- Fully weather stripped throughout providing a tight seal to prevent water and air infiltration

Glass and Glazing:

- Glass Options:
 - 9/16" HS Laminated SGP
- Glass Tint Options
 - Clear
 - Grey Tint
 - Bronze Tint
 - Green Tint
 - Azurelite Blue Tint
 - LoE 366 Clear
 - LoE 366 Grey
 - LoE 366 Bronze
 - LoE 366/I-89
 - Solarban 70 Clear
 - Solarban 70 Grey
 - Solarban 70 Bronze
- Options:
 - White Interlayer
 - Neat
 - Double Tint

Minimum and Maximum Guidelines

PRODUCT ABBREVIATION	MAX FRAME AREA (sq ft)	MAX FRAME WIDTH (in)	MAX FRAME HEIGHT (in)	MAX PANEL AREA (sq ft)	MAX PANEL WIDTH (in)	MAX PANEL HEIGHT (in)	MAX DESIGN PRESSURE (PSF)	OPERATION
COMSD 4.562 IZ4	294.000	423.00	100.250	32.408	48.00	98.375	+90/-110	Residential: 2 – 4 panels Hi-Rise: 2 – 10 panels
COMSD 3.187 IZ4	520.623	756.292	145.875	63.438	84.000	144.000	+80/-80	Pocket: 1 – 10 panels Bypass: 2 – 10 panels
COMSD 3.187 CNR IZ4	319.094 (Male) & 319.124 (Female)	416.397 (Male) & 416.432 (Female)	145.875	63.438	84.000	144.000	+60/-60	Pocket / Bypass: 2 – 10 panels
Max Area Cannot Be Exceeded, Reference Florida Product Approvals For Actual Design Pressure								

Configurations

Bypass Door

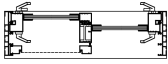
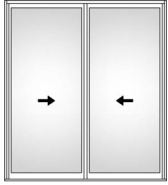

Pocket Door

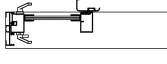
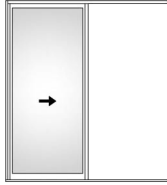

Bypass Door Configurations

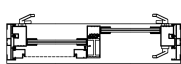
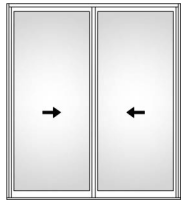

XX

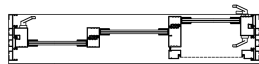
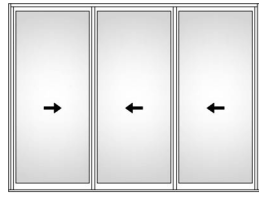

XXX

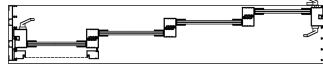
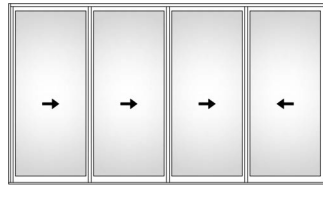

XXXX

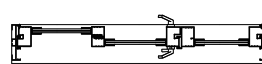
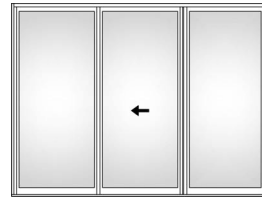

OXO

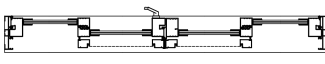
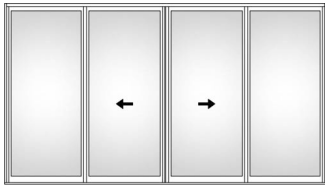

OX-XO

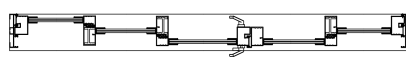
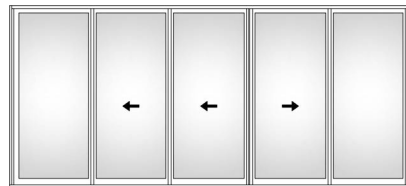

OXX-XO

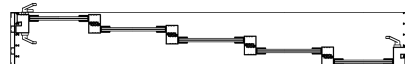
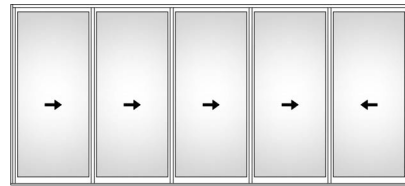

XXXXX

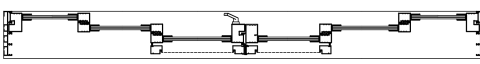
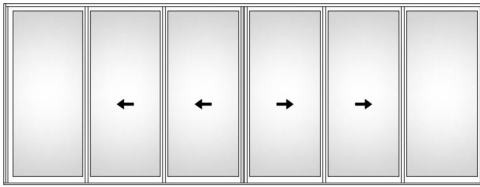

OXX-XXO

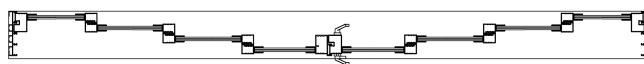
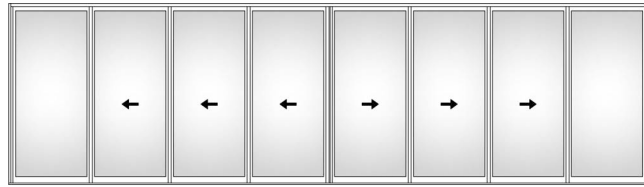

OXXX-XXXO

Pocket Door Configurations

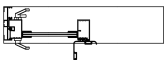
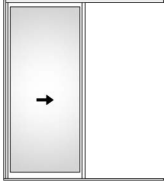

1 Panel Pocket

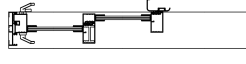
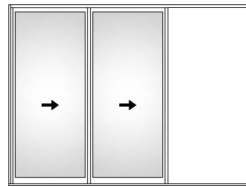

2 Panel Pocket

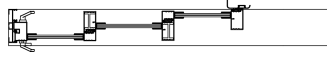
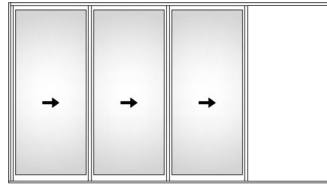

3 Panel Pocket

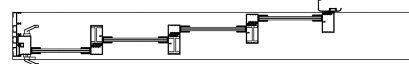
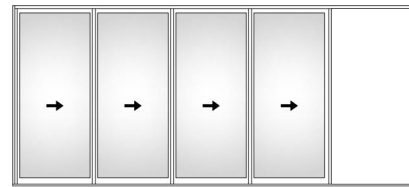

4 Panel Pocket

Section Details COMSD 4.562 IZ4, COMSD 3.187 IZ4, COMSD 3.187 CNR IZ4

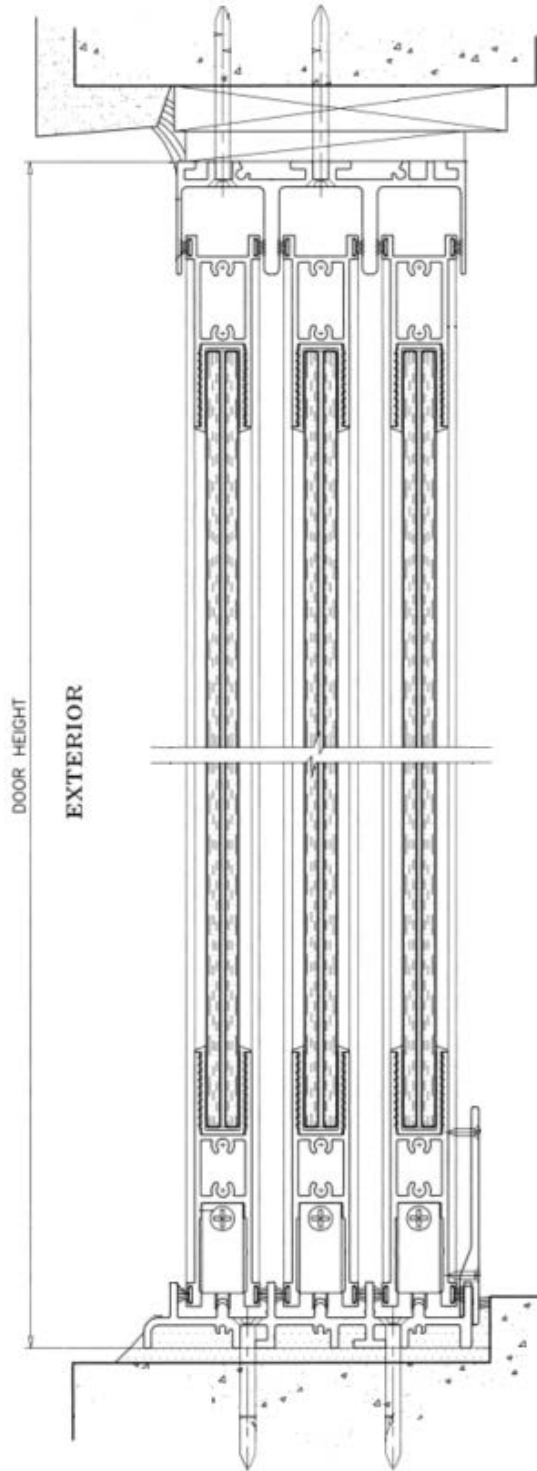

Section Details COMSD 4.562 IZ4

Non-Reinforced Residential Series

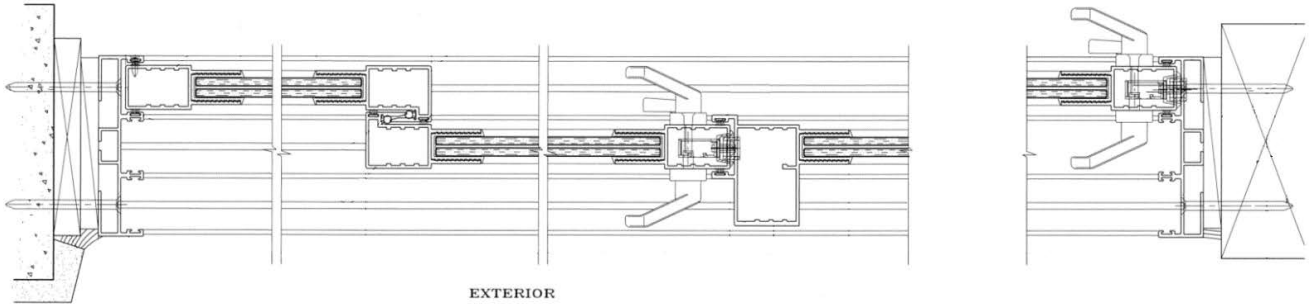

Reinforced Hi-Rise Series

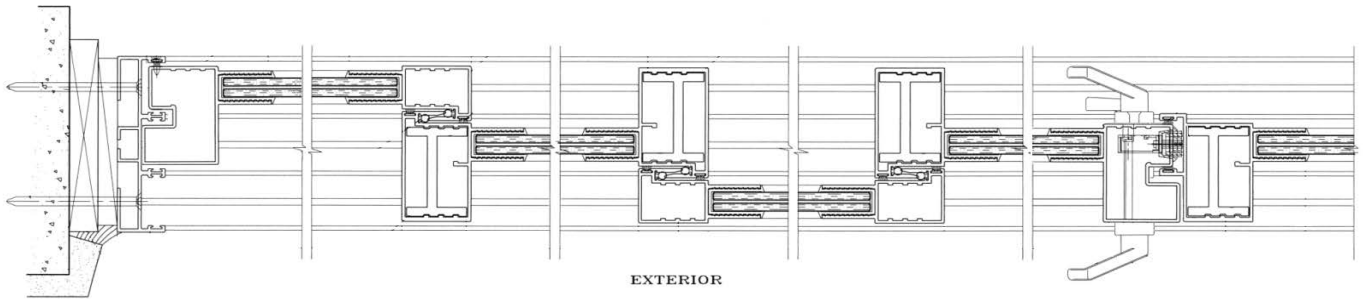

Section Details COMSD 3.187 IZ4

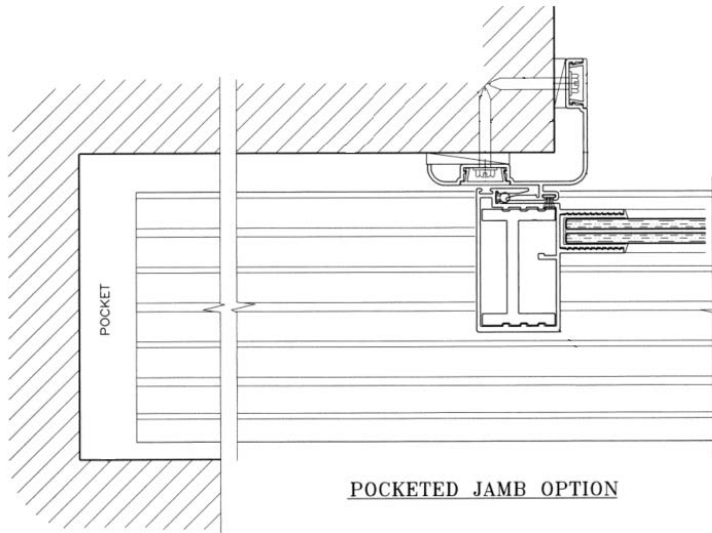
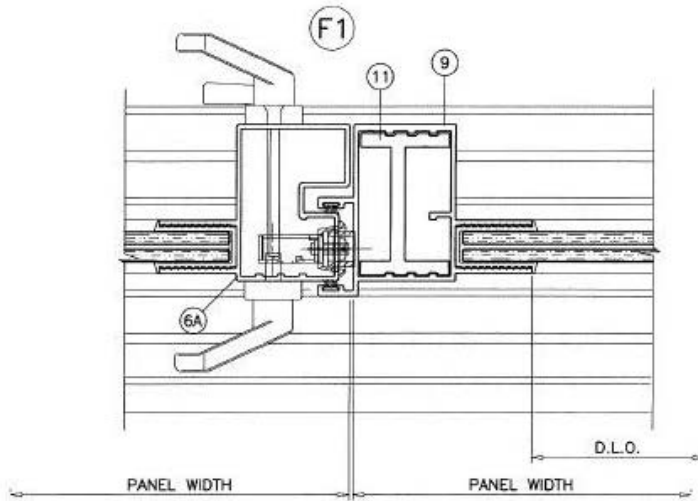
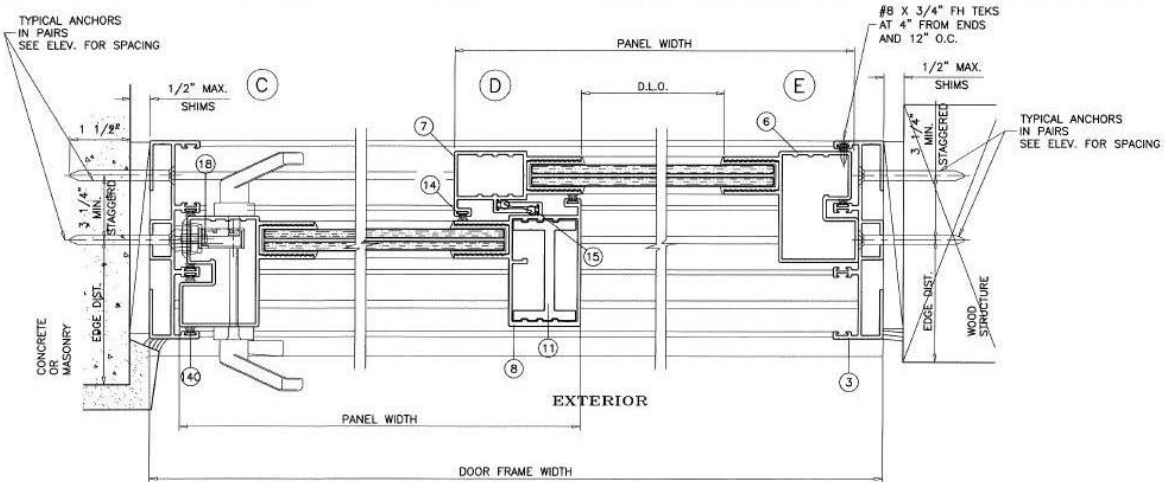

Section Details COMSD CNR 3.187 IZ4

DETAILS APPLICABLE FOR OUTSIDE CORNERS ONLY
 CORNER STILESS CAN BE USED AT 2, 3, 4 AND 5 TRACK DOORS

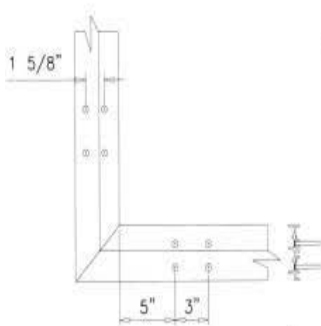
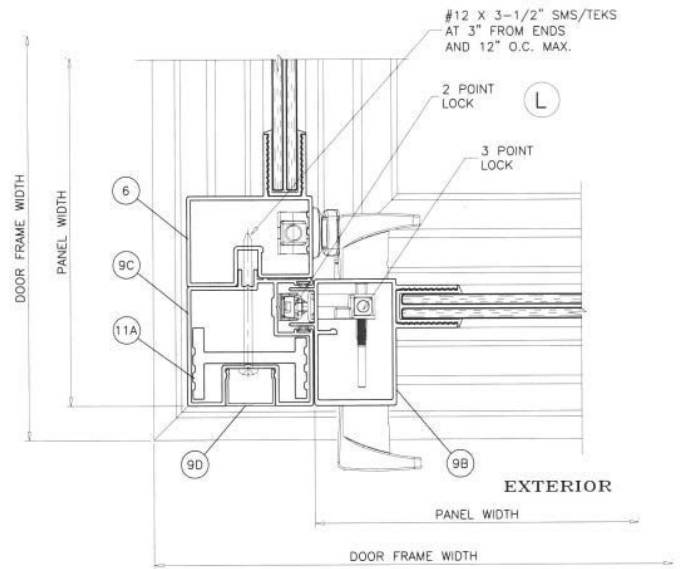
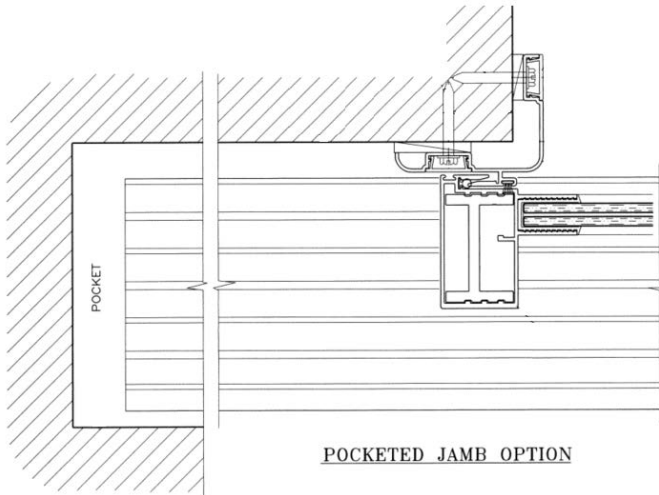

TWO (2) TRACK
 (4) PAIRS

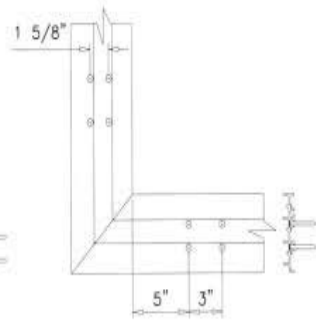

THREE (3) TRACK
 (4) PAIRS

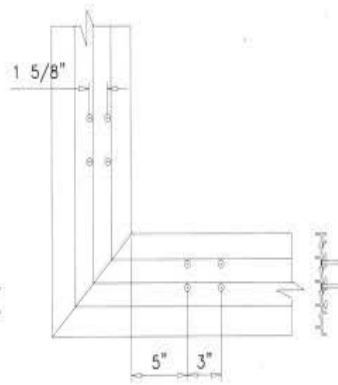

FOUR (4) TRACK
 (4) PAIRS

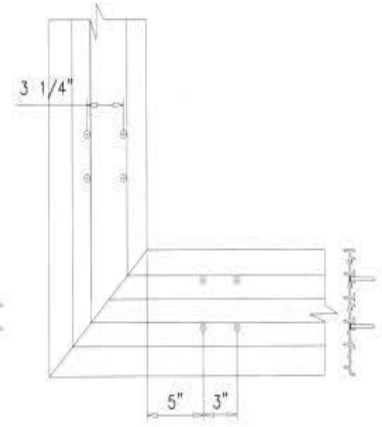

FIVE (5) TRACK
 (4) PAIRS